

**SECTION N - TABLE OF CONTENTS**

**Section N Contents:**

Shelf Brackets, Workstation Brackets & Countertop Supports..... 2 - 9

Brackets with Closet Rod Support..... 10 - 11

Floating Shelves..... 12

Shelf Supports/Pins..... 13 - 20

Hanging Rail Systems..... 21

Closet Tubing, Flanges & Accessories..... 22 - 29

Closet Accessories..... 30 - 35

Pull-Out Closet Baskets & Accessories..... 36 - 38

Tilt-Out Hampers & Pull-Out Hampers..... 39 - 41

Jewelry Organizers & Pull-Out Mirror..... 42 - 43

Slatwall & Accessories..... 44 - 48



A  
B  
C  
D  
E  
F  
G  
H  
I  
J  
K  
L  
M  
N  
O  
P  
Q  
R  
S  
T  
U  
V  
W  
X  
Y



Pull-Out Closet Hampers ↑ pages N-40 - N-41

Pull-Out Closet Baskets page N-36 →

A  
B  
C  
D  
E  
F  
G  
H  
I  
J  
K  
L  
M  
N  
O  
P  
Q  
R  
S  
T  
U  
V  
W  
X  
Y

**SHELF BRACKETS**



**Rigid Extra Heavy Duty Epoxy Coated L-Bracket**



- Load rated at up to 1,000 lbs. per pair
- Corrosion resistant epoxy coated finish
- 5mm bar stock
- Mount into or through a wooden stud using lag bolts 5/16" x 3" or longer

| Dimensions        | Black Epoxy Item # | White Epoxy Item # |
|-------------------|--------------------|--------------------|
| 11-1/2" x 8"      | RV208-300-B        | RV208-300-W        |
| 15-1/2" x 10"     | RV208-400-B        | RV208-400-W        |
| 19-1/2" x 13"     | RV208-500-B        | RV208-500-W        |
| 21-3/8" x 14-1/4" | RV208-550-B        | RV208-550-W        |



**Rigid Extra Heavy Duty Ultimate L-Bracket**



- Load rated at 1,200 lbs. per pair
- Welded steel bracing
- 3/4" steel strut for superior weight capacity
- Often used for countertop installations

| Dimensions    | Black Item # | White Item # |
|---------------|--------------|--------------|
| 11.6" x 8"    | KV208BLK300  | KV208WH300   |
| 15.5" x 10"   | KV208BLK400  | KV208WH400   |
| 19.5" x 13.1" | KV208BLK500  | KV208WH500   |
| 21.4" x 14.2" | KV208BLK550  | KV208WH550   |

**ORDERING MADE EASY!**

Scan Code To Install The New Würth Baer Supply Mobile App!



**SCAN • CHECK • BUY**



For more information contact Würth Baer Supply Webmaster at 888-922-2237 or your local sales representative.

**WORKSTATION BRACKETS**



**Shelf & Countertop Supports**  
**Rigid, Heavy Duty**



- Load rating 1,000 lbs. per pair
- 1/8" steel
- Multiple 1/4" mounting hole locations (mounting hardware not included)
- For use in workbenches, workstations, garage storage, ADA stations, computer stations, etc.
- Reversible design makes brackets versatile and easy to use
- Packaged in equal quantities of "rights" and "lefts"
- The six larger sizes have a 3" x 3" - 45° notch that allows for wall cleat and wire run clearance
- \*Stainless Steel brackets are genuine 304 series stainless steel with a natural brushed finish, 12 gauge, non-magnetic

Note: (-B) sold in full box quantities only.

| Almond Item #                               | Black Item # | Gray Item #  | Primed Item #  | Stainless Steel Item # | White Item # | Box Qty |
|---|--------------|--------------|----------------|------------------------|--------------|---------|
| <b>5" Shelf Length X 8" Wall Length</b>     |              |              |                |                        |              |         |
| DS58ALM                                     | DS58BLK      | DS58GRAY     | -              | -                      | DS58WHT      | 1 Pair  |
| DS58ALM-B                                   | DS58BLK-B    | DS58GRAY-B   | -              | -                      | DS58WHT-B    | 5 Pair  |
| <b>8" Shelf Length X 12" Wall Length *</b>  |              |              |                |                        |              |         |
| DS812ALM                                    | DS812BLK     | DS812GRAY    | -              | DS812SS                | DS812WHT     | 1 Pair  |
| DS812ALM-B                                  | DS812BLK-B   | DS812GRAY-B  | -              | -                      | DS812WHT-B   | 5 Pair  |
| <b>12" Shelf Length X 18" Wall Length</b>   |              |              |                |                        |              |         |
| DS1218ALM                                   | DS1218BLK    | DS1218GRAY   | -              | -                      | DS1218WHT    | 1 Pair  |
| DS1218ALM-B                                 | DS1218BLK-B  | DS1218GRAY-B | -              | -                      | DS1218WHT-B  | 5 Pair  |
| <b>15" Shelf Length X 21" Wall Length *</b> |              |              |                |                        |              |         |
| DS1521ALM                                   | DS1521BLK    | DS1521GRAY   | DS1521PRIMED   | DS1521SS               | DS1521WHT    | 1 Pair  |
| DS1521ALM-B                                 | DS1521BLK-B  | DS1521GRAY-B | DS1521PRIMED-B | -                      | DS1521WHT-B  | 3 Pair  |
| <b>18" Shelf Length X 18" Wall Length</b>   |              |              |                |                        |              |         |
| DS1818ALM                                   | DS1818BLK    | DS1818GRAY   | -              | -                      | DS1818WHT    | 1 Pair  |
| DS1818ALM-B                                 | DS1818BLK-B  | DS1818GRAY-B | DS1818PRIMED-B | -                      | DS1818WHT-B  | 3 Pair  |
| <b>18" Shelf Length X 24" Wall Length *</b> |              |              |                |                        |              |         |
| DS1824ALM                                   | DS1824BLK    | DS1824GRAY   | DS1824PRIMED   | DS1824SS               | DS1824WHT    | 1 Pair  |
| DS1824ALM-B                                 | DS1824BLK-B  | DS1824GRAY-B | DS1824PRIMED-B | -                      | DS1824WHT-B  | 3 Pair  |
| <b>24" Shelf Length X 24" Wall Length</b>   |              |              |                |                        |              |         |
| DS2424ALM                                   | DS2424BLK    | DS2424GRAY   | -              | -                      | DS2424WHT    | 1 Pair  |
| DS2424ALM-B                                 | DS2424BLK-B  | DS2424GRAY-B | -              | -                      | DS2424WHT-B  | 3 Pair  |
| <b>24" Shelf Length X 29" Wall Length</b>   |              |              |                |                        |              |         |
| DS2429ALM                                   | DS2429BLK    | DS2429GRAY   | -              | -                      | DS2429WHT    | 1 Pair  |
| DS2429ALM-B                                 | DS2429BLK-B  | DS2429GRAY-B | -              | -                      | DS2429WHT-B  | 2 Pair  |

A  
B  
C  
D  
E  
F  
G  
H  
I  
J  
K  
L  
M  
N  
O  
P  
Q  
R  
S  
T  
U  
V  
W  
X  
Y

A  
B  
C  
D  
E  
F  
G  
H  
I  
J  
K  
L  
M  
N  
O  
P  
Q  
R  
S  
T  
U  
V  
W  
X  
Y

## SHELF & COUNTERTOP SUPPORTS



### Speed Brace, Heavy Duty Brackets



- Load rating at 1,000 lbs. per pair
- 1-1/2" x 1-1/2" notching system for quick alignment and installation (3/4" x 1-1/2" on FASB58 Series)
- Cable management holes and countersunk screw holes
- 10 piece Speed Brace Anchors: FASB-ANCHOR10PC

**PRECISION ALIGNMENT & NO KICKER!**

| Size                               | Black Item # | Prime Item #  | Stainless Steel Item # | White Item # |
|------------------------------------|--------------|---------------|------------------------|--------------|
| 5" Shelf Length x 8" Wall Length   | FASB58BL     | -             | -                      | FASB58WH     |
| 8" Shelf Length x 12" Wall Length  | FASB812BL    | FASB812PRIME  | FASB812SS              | FASB812WH    |
| 15" Shelf Length x 18" Wall Length | FASB1518BL   | FASB1518PRIME | FASB1518SS             | FASB1518WH   |
| 21" Shelf Length x 24" Wall Length | FASB2124BL   | FASB2124PRIME | FASB2124SS             | FASB2124WH   |
| 21" Shelf Length x 28" Wall Length | FASB2128BL   | FASB2128PRIME | FASB2128SS             | FASB2128WH   |

### Concealed Brackets

- 1/4" steel
- Includes mounting hardware 3/8" x 4" carriage bolts, hex nuts and flat washers
- Mounts directly to wall studs
- Load limit over 1,000 lb. per pair
- All welds on reverse for easy, clean install

Note: Sold in full box quantities only.



| Item#                         | Depth | Overall Height | Color  | Box Qty |
|-------------------------------|-------|----------------|--------|---------|
| <b>9" Support Arm Length</b>  |       |                |        |         |
| DSC1/4-9-ALM                  | 9"    | 12"            | Almond | 2 Each  |
| DSC1/4-9-BLK                  | 9"    | 12"            | Black  | 2 Each  |
| DSC1/4-9-GRAY                 | 9"    | 12"            | Gray   | 2 Each  |
| DSC1/4-9-WHT                  | 9"    | 12"            | White  | 2 Each  |
| <b>12" Support Arm Length</b> |       |                |        |         |
| DSC1/4-12-ALM                 | 12"   | 12"            | Almond | 2 Each  |
| DSC1/4-12-BLK                 | 12"   | 12"            | Black  | 2 Each  |
| DSC1/4-12-GRAY                | 12"   | 12"            | Gray   | 2 Each  |
| DSC1/4-12-WHT                 | 12"   | 12"            | White  | 2 Each  |
| <b>18" Support Arm Length</b> |       |                |        |         |
| DSC1/4-18-ALM                 | 18"   | 18"            | Almond | 2 Each  |
| DSC1/4-18-BLK                 | 18"   | 18"            | Black  | 2 Each  |
| DSC1/4-18-GRAY                | 18"   | 18"            | Gray   | 2 Each  |
| DSC1/4-18-WHT                 | 18"   | 18"            | White  | 2 Each  |
| <b>24" Support Arm Length</b> |       |                |        |         |
| DSC1/4-24-ALM                 | 24"   | 18"            | Almond | 2 Each  |
| DSC1/4-24-BLK                 | 24"   | 18"            | Black  | 2 Each  |
| DSC1/4-24-GRAY                | 24"   | 18"            | Gray   | 2 Each  |
| DSC1/4-24-WHT                 | 24"   | 18"            | White  | 2 Each  |

**SHELF & COUNTERTOP SUPPORTS**

**EH Series Surface Mount Bracket**

- Rakks Counter Support Brackets keep work areas open and accessible
- They provide heavy duty support for counters up to 30" deep while improving the handicapped accessibility and ergonomics of the work area
- Rakks counter support brackets are manufactured from easy-to-recycle structural aluminum



| Item #                           | Size      | Counter Depth | Weight Capacity    | Finish           |
|----------------------------------|-----------|---------------|--------------------|------------------|
| <b>Surface Mount - 12" X 9"</b>  |           |               |                    |                  |
| RNEH-1209                        | 12" x 9"  | 13"           | 650 lb per bracket | Mill             |
| RNEH-1209-B                      | 12" x 9"  | 13"           | 650 lb per bracket | Black            |
| RNEH-1209-W                      | 12" x 9"  | 13"           | 650 lb per bracket | Off-White/Primed |
| <b>Surface Mount - 12" X 12"</b> |           |               |                    |                  |
| RNEH-1212                        | 12" x 12" | 18"           | 650 lb per bracket | Mill             |
| RNEH-1212-B                      | 12" x 12" | 18"           | 650 lb per bracket | Black            |
| RNEH-1212-W                      | 12" x 12" | 18"           | 650 lb per bracket | Off-White/Primed |
| <b>Surface Mount - 18" X 18"</b> |           |               |                    |                  |
| RNEH-1818                        | 18" x 18" | 24"           | 450 lb per bracket | Mill             |
| RNEH-1818-A                      | 18" x 18" | 24"           | 450 lb per bracket | Clear Ano        |
| RNEH-1818-B                      | 18" x 18" | 24"           | 450 lb per bracket | Black            |
| RNEH-1818-W                      | 18" x 18" | 24"           | 450 lb per bracket | Off-White/Primed |
| <b>Surface Mount - 18" X 24"</b> |           |               |                    |                  |
| RNEH-1824                        | 18" x 24" | 30"           | 450 lb per bracket | Mill             |
| RNEH-1824-A                      | 18" x 24" | 30"           | 450 lb per bracket | Clear Ano        |
| RNEH-1824-B                      | 18" x 24" | 30"           | 450 lb per bracket | Black            |
| RNEH-1824-W                      | 18" x 24" | 30"           | 450 lb per bracket | Off-White/Primed |
| <b>Flush Mount - 12" x 9"</b>    |           |               |                    |                  |
| RNEH-1209FM                      | 12" x 9"  | 13"           | 430 lb per bracket | Mill             |
| RNEH-1209FM-B                    | 12" x 9"  | 13"           | 430 lb per bracket | Black            |
| RNEH-1209FM-W                    | 12" x 9"  | 13"           | 430 lb per bracket | Off-White/Primed |
| <b>Flush Mount - 12" X 12"</b>   |           |               |                    |                  |
| RNEH-1212FM                      | 12" x 12" | 18"           | 430 lb per bracket | Mill             |
| RNEH-1212FM-A                    | 12" x 12" | 18"           | 430 lb per bracket | Clear Ano        |
| RNEH-1212FM-B                    | 12" x 12" | 18"           | 430 lb per bracket | Black            |
| RNEH-1212FM-W                    | 12" x 12" | 18"           | 430 lb per bracket | Off-White/Primed |
| <b>Flush Mount - 18" X 18"</b>   |           |               |                    |                  |
| RNEH-1818FM                      | 18" x 18" | 24"           | 300 lb per bracket | Mill             |
| RNEH-1818FM-A                    | 18" x 18" | 24"           | 300 lb per bracket | Clear Ano        |
| RNEH-1818FM-B                    | 18" x 18" | 24"           | 300 lb per bracket | Black            |
| RNEH-1818FM-W                    | 18" x 18" | 24"           | 300 lb per bracket | Off-White/Primed |
| <b>Flush Mount - 18" X 24"</b>   |           |               |                    |                  |
| RNEH-1824FM                      | 18" x 24" | 30"           | 300 lb per bracket | Mill             |
| RNEH-1824FM-A                    | 18" x 24" | 30"           | 300 lb per bracket | Clear Ano        |
| RNEH-1824FM-B                    | 18" x 24" | 30"           | 300 lb per bracket | Black            |
| RNEH-1824FM-W                    | 18" x 24" | 30"           | 300 lb per bracket | Off-White/Primed |

A  
B  
C  
D  
E  
F  
G  
H  
I  
J  
K  
L  
M  
N  
O  
P  
Q  
R  
S  
T  
U  
V  
W  
X  
Y

A  
B  
C  
D  
E  
F  
G  
H  
I  
J  
K  
L  
M  
N  
O  
P  
Q  
R  
S  
T  
U  
V  
W  
X  
Y

## SHELF & COUNTERTOP SUPPORTS

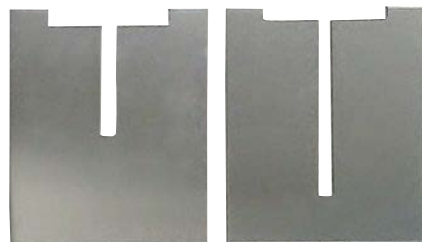

### Inside Wall Counter Support Face Plate

**Rakks®**

- Designed to work with Rakks EH-1818, EH-1824, EH-1212 and EH-1209 Flush-Mount Counter Supports
- Adhesive backed plate fits over the supporting arm of the bracket and eliminates the need to patch and fill the drywall

| Item #    | Size            | Finish   | Use With  |
|-----------|-----------------|----------|---|
| RNEH-FP22 | 2" x 2" x 1/4"  | Aluminum | EH-1818, EH-1212 and EH-1209 Flush Mount Supports |
| RNEH-FP23 | 2" x 3" x 3/16" | Aluminum | EH-1824 Flush Mount Supports                      |

### Concealed Brackets With Upper Extension

- 1/4" steel
  - Includes mounting hardware 3/8" x 4" carriage bolts, hex nuts and flat washers
  - Mounts directly to wall studs
  - Load limit over 1,000 lb. per pair
  - All welds on reverse for easy, clean install
- Note: Sold in full box quantities only.



| Item#                         | Depth | Overall Height | Color  | Box Qty |
|-------------------------------|-------|----------------|--------|---------|
| <b>9" Support Arm Length</b>  |       |                |        |         |
| DSEC1/4-9-ALM                 | 9"    | 20"            | Almond | 2 Each  |
| DSEC1/4-9-BLK                 | 9"    | 20"            | Black  | 2 Each  |
| DSEC1/4-9-GRAY                | 9"    | 20"            | Gray   | 2 Each  |
| DSEC1/4-9-WHT                 | 9"    | 20"            | White  | 2 Each  |
| <b>12" Support Arm Length</b> |       |                |        |         |
| DSEC1/4-12-ALM                | 12"   | 20"            | Almond | 2 Each  |
| DSEC1/4-12-BLK                | 12"   | 20"            | Black  | 2 Each  |
| DSEC1/4-12-GRAY               | 12"   | 20"            | Gray   | 2 Each  |
| DSEC1/4-12-WHT                | 12"   | 20"            | White  | 2 Each  |
| <b>18" Support Arm Length</b> |       |                |        |         |
| DSEC1/4-18-ALM                | 18"   | 26"            | Almond | 2 Each  |
| DSEC1/4-18-BLK                | 18"   | 26"            | Black  | 2 Each  |
| DSEC1/4-18-GRAY               | 18"   | 26"            | Gray   | 2 Each  |
| DSEC1/4-18-WHT                | 18"   | 26"            | White  | 2 Each  |
| <b>24" Support Arm Length</b> |       |                |        |         |
| DSEC1/4-24-ALM                | 24"   | 26"            | Almond | 2 Each  |
| DSEC1/4-24-BLK                | 24"   | 26"            | Black  | 2 Each  |
| DSEC1/4-24-GRAY               | 24"   | 26"            | Gray   | 2 Each  |
| DSEC1/4-24-WHT                | 24"   | 26"            | White  | 2 Each  |

**SHELF & COUNTERTOP SUPPORTS**



**Hybrid Workstation Brackets**



- Can be installed as either a Flush Mount or Concealed (floating) Bracket
  - Multiple 1/4 inch mounting holes (hardware not included)
  - 1/8 inch steel construction
  - 3/4 inch x 1.5 inch vertical tube
  - 1.5 inch horizontal T
  - Finishing caps provided
- Packing: 2 each per box.  
Sold In: Full box quantities only.

| Item #         | Size      | Weight Capacity   | Finish |
|----------------|-----------|-------------------|--------|
| AHMYBRID12-BLK | 12" x 12" | 2,200 lb per pair | Black  |
| AHMYBRID12-WHT | 12" x 12" | 2,200 lb per pair | White  |
| AHMYBRID18-BLK | 18" x 18" | 1,300 lb per pair | Black  |
| AHMYBRID18-WHT | 18" x 18" | 1,300 lb per pair | White  |

| Item #         | Size      | Weight Capacity   | Finish |
|----------------|-----------|-------------------|--------|
| AHMYBRID24-BLK | 24" x 24" | 1,050 lb per pair | Black  |
| AHMYBRID24-WHT | 24" x 24" | 1,050 lb per pair | White  |

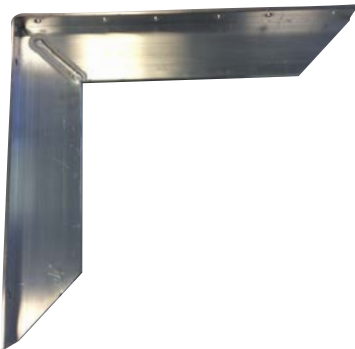

**EH B Series Surface Mount Bench Support Bracket**

- Used for seating applications incorporating 5" wooden planking
- The supporting arm is pre-drilled with 12 holes to provide secure installation
- Manufactured from 2" x 3" "T" to provide maximum stiffness



| Item #     | Weight Capacity    | Size              | Finish |
|------------|--------------------|-------------------|--------|
| RNEH-1416B | 450 lb per bracket | 14-3/4" x 15-3/4" | Mill   |



**FB Sill Support Bracket**



- Manufactured from structural aluminum angle
- These brackets can be used anywhere low profile support or bracing is required

| Item #    | Weight Capacity    | Size        | Finish |
|-----------|--------------------|-------------|--------|
| RNFB-0406 | 150 lb per bracket | 4" D x 6" H | Mill   |



**EH Series Vanity Brackets**



- ADA compliant aluminum vanity brackets simplify and reduce the cost of installing sinks and provide a stable and sturdy mounting surface for custom-built enclosures
- Vanity Brackets are supplied with wooden strips on the front faces to provide for the convenient mounting, or removal, of laminated or solid surface panels

| Item #       | Weight Capacity     | Size          | Finish |
|--------------|---------------------|---------------|--------|
| RNEH-1818-LV | 450 lb. per Bracket | 18" x 21-1/2" | Mill   |

A  
B  
C  
D  
E  
F  
G  
H  
I  
J  
K  
L  
M  
N  
O  
P  
Q  
R  
S  
T  
U  
V  
W  
X  
Y

## COUNTERTOP SUPPORTS & SHELF BRACKETS



### Stealth Brace

- Support countertop and bar overhangs with no visible kicker or corbels
- Countersunk screwholes
- Simply route a 3-1/2" slot in the substrate and mount
- Sold in eaches



| Size                 | Weight Capacity | Black Item #    | Prime Item #       | White Item #   |
|----------------------|-----------------|-----------------|--------------------|----------------|
| <b>Standard Duty</b> |                 |                 |                    |                |
| 3-1/2" x 12" x 3/16" | 300 lb per pair | FASTEALTH-12BL  | FASTEALTH-12PRIMED | FASTEALTH-12WH |
| 3-1/2" x 16" x 3/16" | 300 lb per pair | FASTEALTH-16BL  | FASTEALTH-16PRIMED | -              |
| 3-1/2" x 24" x 3/16" | 300 lb per pair | FASTEALTH-24BL  | FASTEALTH-24PRIMED | -              |
| 3-1/2" x 30" x 3/16" | 300 lb per pair | FASTEALTH-30BL  | FASTEALTH-30PRIMED | -              |
| <b>Heavy Duty</b>    |                 |                 |                    |                |
| 3-1/2" x 12" x 1/4"  | 500 lb per pair | FASTEALTHHD12BL | FASTEALTHHD12PRIME | -              |
| 3-1/2" x 16" x 3/8"  | 500 lb per pair | FASTEALTHHD16BL | -                  | -              |
| 3-1/2" x 24" x 3/8"  | 500 lb per pair | FASTEALTHHD24BL | -                  | -              |
| 3-1/2" x 30" x 3/8"  | 500 lb per pair | FASTEALTHHD30BL | -                  | -              |



### Silhouette Shelf Bracket

- BHMA Grade 2 Compliant
- Heavy-duty steel, center rib for superior strength
- Countersunk screw holes



| 8" Item # | 10" Item#  | 12" Item#  | Description              | Finish |
|-----------|------------|------------|--------------------------|--------|
| KV217WH-8 | KV217WH-10 | KV217WH-12 | Silhouette Shelf Bracket | White  |



### Heavy-Duty Fixed Shelf Bracket

- 14 gauge steel construction
- Holds up to 500 lbs. per pair



| 12" Item #   | 16" Item#    | Description              | Finish |
|--------------|--------------|--------------------------|--------|
| KV1187BPWT12 | KV1187BPWT16 | Heavy-Duty Shelf Bracket | White  |



**SHELF BRACKETS**



**Rigid Decorative Bracket**

John Sterling Corporation

- Steel, powder coated.

| Item#     | Size            | Color    | Load Rating       |
|-----------|-----------------|----------|-------------------|
| SG53-10PM | 9-3/4" x 7-3/4" | Platinum | 100 lbs. per pair |
| SG53-7BK  | 6-3/4" x 5-5/8" | Black    | 100 lbs. per pair |

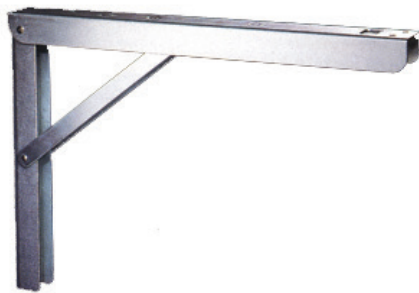

**Folding Shelf Bracket, Heavy Duty**



- Locks in at 4 positions (Flat, 70°, 80°, 90°)
- Spring loaded to automatically lock
- Front locking lever makes releasing easy

| Item#      | Size                       | Finish | Load Rating      |
|------------|----------------------------|--------|------------------|
| KV206ZC-12 | 11.81"D x 7.87"H x 1.18"W  | Zinc   | 750 lbs per pair |
| KV206ZC-16 | 15.75"D x 10.63"H x 1.42"W | Zinc   | 880 lbs per pair |



**Folding Shelf Bracket**



- For drop down shelves from 8" to 24" wide
- Automatic safety locking device
- Quick release folding mechanism
- Solid rivet construction
- Recommended fasteners (sold separately): #8 flat head wood screws (12 per pair)

Packing & Sold In: Pairs

| Item#         | Shelf Length x Wall Length | Finish      | Load Rating  |
|---------------|----------------------------|-------------|--------------|
| FR505GE-12X12 | 12"SL x 12"WL              | Gray Enamel | 150 per pair |



**Folding Shelf Bracket**



- Made of 304 Stainless Steel
- Screws not included

| Item#     | Size                | Finish           | Load Rating       |
|-----------|---------------------|------------------|-------------------|
| SLEB303EP | 12-1/32"W x 6-1/2"H | Electro Polished | 330 lbs. per pair |

A  
B  
C  
D  
E  
F  
G  
H  
I  
J  
K  
L  
M  
N  
O  
P  
Q  
R  
S  
T  
U  
V  
W  
X  
Y



**BRACKETS WITH CLOSET ROD SUPPORT**



A (Adjustable Regular-Duty)



B (Adjustable Heavy-Duty)



C (Heavy-Duty)



D (Heavy-Duty)



E (Extra-Duty)

|   | Item#         | Size                         | Finish         | Gauge | Load Rating Per Pair | Shelf Depth   | Shelf Platform    | Accepts Rod Size Up To | Hook Depth |
|---|---------------|------------------------------|----------------|-------|----------------------|---------------|-------------------|------------------------|------------|
| A | KV1192BPWT12  | 12.125"D x 9.625"H x 1.0"W   | White          | 14    | 300 Lbs.             | 11" - 14"     | 10-1/4" - 10-3/4" | 1-3/8"                 | 3"H        |
| B | KV1194WH-1    | 12.125"D x 9.625"H x 1.0"W   | White          | 13    | 500 Lbs.             | 11" - 14"     | 10-1/4" - 10-3/4" | 1-3/8"                 | 3"H        |
|   | KV1194CR-1    | 12.125"D x 9.625"H x 1.0"W   | Cream          | 13    | 500 Lbs.             | 11" - 14"     | 10-1/4" - 10-3/4" | 1-3/8"                 | 3"H        |
| C | KV1195WH-1    | 12.5"D x 9.125"H x 0.937"W   | White          | 12    | 500 Lbs.             | 11" - 14"     | 11"               | 1-3/8"                 | 2-1/2"H    |
|   | KV1195CR-1    | 12.5"D x 9.125"H x 0.937"W   | Cream          | 12    | 500 Lbs.             | 11" - 14"     | 11"               | 1-3/8"                 | 2-1/2"H    |
| D | KV1196BPWT12  | 12.625"D x 9.562"H x 1"W     | White          | 14    | 500 Lbs.             | 11" - 14"     | 11"               | 1-3/8"                 | 3"H        |
|   | KV1196BPCHR12 | 12.625"D x 9.562"H x 1"W     | Chrome         | 14    | 500 Lbs.             | 11" - 14"     | 11"               | 1-3/8"                 | 3"H        |
| E | KV1198BPN12   | 12.375"D x 7.937"H x 1.062"W | Brushed Nickel | 10    | 1,000 Lbs.           | 11-1/2" - 14" | 11-1/4"           | 1-1/4" - 1-5/16"       | 3"H        |
|   | KV1198BPRZ12  | 12.375"D x 7.937"H x 1.062"W | Bronze         | 10    | 1,000 Lbs.           | 11-1/2" - 14" | 11-1/4"           | 1-1/4" - 1-5/16"       | 3"H        |
|   | KV1198BPCHR12 | 12.375"D x 7.937"H x 1.062"W | Chrome         | 10    | 1,000 Lbs.           | 11-1/2" - 14" | 11-1/4"           | 1-1/4" - 1-5/16"       | 3"H        |
|   | KV1198BPWT12  | 12.375"D x 7.937"H x 1.062"W | Warm White     | 10    | 1,000 Lbs.           | 11-1/2" - 14" | 11-1/4"           | 1-1/4" - 1-5/16"       | 3"H        |

**BRACKETS WITH CLOSET ROD SUPPORT & 90° CORNER BRACKETS**



**Brackets With Closet Rod Support  
Brass & Chrome Finish, Heavy Duty**



- Doubles as a shelf holder and a pole bracket
- Designed to support shelves up to 12" wide and up to a 1-1/2" diameter rod or dowel
- Rated at 150 lbs. per pair

| Item#        | Shelf Length (SL) x Wall Length (WL) | Finish          |
|--------------|--------------------------------------|-----------------|
| LC8150PB     | 12" SL x 10-7/8" WL                  | Bright Brass    |
| LCLB10-8150A | 12"SL x 10-7/8"WL                    | Polished Chrome |

A  
B  
C  
D  
E  
F  
G  
H  
I  
J  
K  
L  
M  
N  
O  
P  
Q  
R  
S  
T  
U  
V  
W  
X  
Y



**Shelf Edging/Stiffener, Anodized Aluminum**



- For use on the edge of 3/4" material
- Used primarily for garage shelves for a "finished look"
- Also gives added support to the edge of the shelf

| Item#   | Finish    | Length |
|---------|-----------|--------|
| GTUC-32 | Anochrome | 8'     |



**90° Corner Brackets**



- Used to attach 3/4" shelving at a 90° corner of a closet
- Available in 14" and 16" lengths and are easy to cut to size
- Made of heavy duty plastic

| Item#                      | Description                | Finish |
|----------------------------|----------------------------|--------|
| <b>14" Length Brackets</b> |                            |        |
| PLH-080-001BK              | 90° Plastic Corner Bracket | Black  |
| PLH-080-001BR              | 90° Plastic Corner Bracket | Brown  |
| PLH-080-001WH              | 90° Plastic Corner Bracket | White  |
| <b>16" Length Brackets</b> |                            |        |
| PLH-080-002BK              | 90° Plastic Corner Bracket | Black  |
| PLH-080-002BR              | 90° Plastic Corner Bracket | Brown  |
| PLH-080-002WH              | 90° Plastic Corner Bracket | White  |

A  
B  
C  
D  
E  
F  
G  
H  
I  
J  
K  
L  
M  
N  
O  
P  
Q  
R  
S  
T  
U  
V  
W  
X  
Y

## FLOATING SHELVES & FLOATING SHELF BRACKETS



### Solid Wood Floating Shelves

- Perfect for today's transitional and contemporary kitchen/bath
- System includes floating shelf, hanging brackets & hardware for mounting
- Hanging system safely supports 15 lbs. per foot of shelf length, exceeds KCMA requirements
- Shelves are 2-1/2" thick x 10" depth, trimmable to 2" depth
- Solid wood & wood veneer construction (Paint Grade is Poplar and MDF)



| Species           | Item #       |
|-------------------|--------------|
| <b>24" Length</b> |              |
| Maple             | NPFS0124MUF1 |
| Cherry            | NPFS0124CUF1 |
| Paint Grade       | NPFS0124XUF1 |
| <b>30" Length</b> |              |
| Maple             | NPFS0130MUF1 |
| Cherry            | NPFS0130CUF1 |
| Paint Grade       | NPFS0130XUF1 |

| Species           | Item #       |
|-------------------|--------------|
| <b>36" Length</b> |              |
| Maple             | NPFS0136MUF1 |
| Cherry            | NPFS0136CUF1 |
| Paint Grade       | NPFS0136XUF1 |
| <b>42" Length</b> |              |
| Maple             | NPFS0142MUF1 |
| Paint Grade       | NPFS0142XUF1 |
| <b>48" Length</b> |              |
| Maple             | NPFS0148MUF1 |
| Paint Grade       | NPFS0148XUF1 |



### Floating Shelf Bracket Set

- Maximum Load Capacity for shelf size 8"D x 35"L: 37.4 Lbs.
- Maximum Load Capacity for shelf size 12"D x 35"L: 25.3 Lbs.
- **Note: The Tests are achieved by 2 supports with a shelf length of 35". For every 18" additional shelf length, please add additional shelf support.**
- Completely concealed
- It can be adjusted in any direction



| Item#         | Description   |
|---------------|---|
| CM632-500-105 | Includes: (1) Wall Support, (1) Rod Mount, (4) Plastic Wall Plugs & (4) Phillips Screws |



### Shelf Supports For Shelves Up To 2" Thick

- Fitting allows a shelf to be attached to a wall without any visible support
- Minimum shelf thickness of 7/8"
- Two supports are rated for 90 pound loads and three supports are rated for 135 lb. loads
- 1 set consists of: (1) shelf supporter, (1) hooking, anchors and screws



| Item# |
|-------|
| CNT3  |

**METAL SHELF SUPPORTS/PINS**



**Spoon Shaped Shelf Support, 5mm & 1/4" Bores**



- 5mm bore spoon shaped supports have 3/8" L x 5/16" W shelf rest area
- 1/4" bore spoon shaped supports have a 1/2" L x 5/16" W shelf rest area
- 5mm bore pin is 3/8" L and 1/4" bore pin is 5/16" L
- Sold In: Full Box Quantities

| Finish           | Item#     | Box Qty | Item#   | Box Qty |
|------------------|-----------|---------|---------|---------|
| <b>5mm Bore</b>  |           |         |         |         |
| Brass            | IF515BPC  | 100     | IF515BP | 1,000   |
| Nickel           | IF711NP-C | 100     | IF711NP | 1,000   |
| Black            | IF613BLC  | 100     | IF613BL | 1,000   |
| <b>1/4" Bore</b> |           |         |         |         |
| Brass            | IF533BPC  | 100     | IF533BP | 1,000   |
| Nickel           | IF739NP-C | 100     | IF739NP | 1,000   |



**Spoon Shaped Shelf Support, 5mm Bore**



- Pin Length: 5/16" (8mm)
- Shelf Rest: 5/16" (8mm) wide x 7/16" (11mm) long
- Sold In: Full Box Quantities

| Item#    | Description                    | Finish    | Box Qty |
|----------|--------------------------------|-----------|---------|
| KV332ANO | 5mm Spoon Shaped Shelf Support | Anochrome | 1,000   |



**Spoon Shaped Shelf Support, 1/4" Bore**



- For 1/4" hole
- Pin Length: 3/8" (9mm)
- Shelf Rest: 3/8" (9mm) wide x 1/2" (13mm) long
- Sold In: Full Box Quantities

| Item#    | Description                     | Finish    | Box Qty |
|----------|---------------------------------|-----------|---------|
| KV331ANO | 1/4" Spoon Shaped Shelf Support | Anochrome | 1,000   |

A  
B  
C  
D  
E  
F  
G  
H  
I  
J  
K  
L  
M  
N  
O  
P  
Q  
R  
S  
T  
U  
V  
W  
X  
Y

A  
B  
C  
D  
E  
F  
G  
H  
I  
J  
K  
L  
M  
N  
O  
P  
Q  
R  
S  
T  
U  
V  
W  
X  
Y

## ROD SHELF SUPPORTS & SHELF SUPPORT GROMMETS



### Steel Rod Shaped Shelf Support 5mm Bore With Center Stop



- Overall rod length is 5/8"
- Sold in full box quantity

| Item#    | Finish | Box Qty |
|----------|--------|---------|
| IF1401ZN | Zinc   | 1,000   |



### Solid Steel Shelf Pin Rest, 5mm Bore



- Solid steel nickel-plated shelf rest to fit 5mm hole borings
- Shelf support protrudes 19/32" and is 5/16" diameter
- Pin measures 5mm (3/16") dia. and is 5/16" long permitting pins to be introduced on both sides of a 5/8" thick wall
- Sold In: Full box quantities

| Item#  | Box Qty |
|--------|---------|
| CN3014 | 500     |



### Shelf Support Grommet, 5mm & 1/4" Bores



- Sized to accept 5mm and 1/4" bore shelf pins
- 5mm grommet requires 7/32" (5.3mm) diameter hole size while 1/4" grommet requires 17/64" (6.7mm) diameter hole to accommodate grommet
- 5mm bore grommet depth of 3/16", while the 1/4" bore grommet depth is 1/4"
- Sold in full box quantity

| Shelf Pin Bore Size | Finish        | Item #     | Box Qty |
|---------------------|---------------|------------|---------|
| 5mm                 | Nickel Plated | IF1326NP   | 1,000   |
| 1/4"                | Nickel Plated | IF1325NP-C | 100     |
| 1/4"                | Nickel Plated | IF1325NP   | 1,000   |

**METAL SHELF SUPPORTS**



**“L” Shaped Steel Shelf Support  
5mm & 1/4” Bores**



- “L” shaped supports have 5/8”L x 1/2” W shelf rest area
- Support has hole to accommodate screw for affixing to shelf
- 5mm bore pin length is 5/16”, 1/4” bore pin length is 3/8”
- Sold in full box quantity

| Finish           | Item #      | Box Qty | Item #    | Box Qty |
|------------------|-------------|---------|-----------|---------|
| <b>5mm Bore</b>  |             |         |           |         |
| Brass            | IF1345BP-C  | 100     | IF1345BP  | 1,000   |
| Nickel           | IF1345NP-C  | 100     | IF1345NP  | 1,000   |
| Brown            | IF1345WAL-C | 100     | IF1345WAL | 1,000   |
| <b>1/4” Bore</b> |             |         |           |         |
| Brass            | IF1346BP-C  | 100     | IF1346BP  | 1,000   |
| Nickel           | IF1346NP-C  | 100     | IF1346NP  | 1,000   |
| Brown            | -           | 100     | IF1346WAL | 1,000   |



**“L” Shaped Metal Shelf Pins  
1/4” Bore**



- Pin length: 3/8” (9mm)
- Shelf Rest: 1/2” (9mm) wide x 11/16” (17mm) long
- Sold In: Full Box Quantity

| Item #   | Finish    | Box Qty |
|----------|-----------|---------|
| KV346ANO | Anochrome | 100     |



**“L” Shaped Brass Shelf Support  
5mm Bore**



- Pin Diameter: 4.7mm, for 5mm hole (use with KV129 rubber cushion)
- Pin Length: 5/16” (8mm)
- Dimensions: 1/2” (13mm) wide x 11/16” (17mm) long
- Sold In: Full Box Quantity

| Item#     | Finish | Box Qty |
|-----------|--------|---------|
| KVCS345NP | Nickel | 100     |

A  
B  
C  
D  
E  
F  
G  
H  
I  
J  
K  
L  
M  
N  
O  
P  
Q  
R  
S  
T  
U  
V  
W  
X  
Y

A  
B  
C  
D  
E  
F  
G  
H  
I  
J  
K  
L  
M  
N  
O  
P  
Q  
R  
S  
T  
U  
V  
W  
X  
Y

**METAL & PLASTIC SHELF SUPPORTS**



**"L" Shaped Steel Shelf Support  
With Vinyl Tip, 5mm Bore**



- "L" shaped supports have 3/4" L x 5/8"W shelf rest area
- Pin length is 5/16"
- Sold in full box quantity

| Item #    | Support Finish | Viny Tip Color | Box Qty |
|-----------|----------------|----------------|---------|
| IF1348BRN | Brass          | Brown          | 1,000   |
| IF1348WH  | Nickel         | White          | 1,000   |



**"L" Shaped Steel Shelf Support  
With Vinyl Tip, 5mm Bore**



- Pin length is 5/16" (8mm)
- Shelf support is 1/2" (13mm) wide x 11/16" (17mm) long
- Sold in full box quantity

| Item#      | Support Finish | Viny Tip Color | Box Qty |
|------------|----------------|----------------|---------|
| KV348ALM-C | Brass          | Almond         | 100     |
| KV348ALM   | Brass          | Almond         | 1,000   |



**Plastic Shelf Support Pins  
5mm Bore**



- Pin length: 5/16" (8mm)
- Shelf Rest: 7/16" (8mm) wide x 13/32" (10mm) long
- Sold In: Full Box Quantity

| Item #  | Finish | Box Qty |
|---------|--------|---------|
| KV338CL | Clear  | 100     |



**PLASTIC SHELF SUPPORTS**



**Plastic Shelf Support With Steel Pin  
5mm Bore, Value Priced**



- Pin length is 5/16"
- Shelf rest area is 13/32" L x 7/16" W
- Plastic support with steel pin
- Sold in full box quantity

| Finish | Item #      | Box Qty | Item #    | Box Qty |
|--------|-------------|---------|-----------|---------|
| Clear  | IF1338CLR-C | 100     | IF1338CLR | 1,000   |
| White  | -           | -       | IF1338WHT | 1,000   |
| Almond | -           | -       | IF1338ALM | 1,000   |



**Plastic Locking Shelf Support  
5mm & 1/4" Bores**



- Plastic shelf locking support clips for 1/2", 5/8" and 3/4" shelves
- Shelf rest area is 1/2" L x 3/4" W

Packing: As shown below.

Sold In: Full box quantities only.

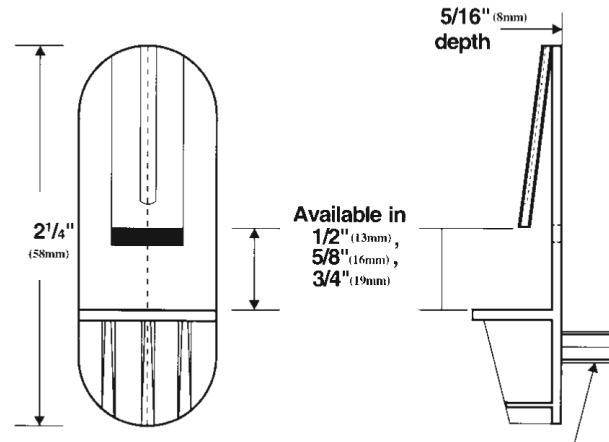

| For Use With | Finish | 1/4" Bore<br>Box Qty: 1,000<br>Item# | 5mm<br>Box Qty: 100<br>Item # | 5mm<br>Box Qty: 1,000<br>Item # |
|--------------|--------|--------------------------------------|-------------------------------|---------------------------------|
| 1/2" Shelves | White  | -                                    | RSRAS305-12-10-C              | RSRAS305-12-10-4                |
| 3/4" Shelves | Clear  | RSJPE301-34-020-1                    | -                             | RSRAS305-34-020                 |
| 3/4" Shelves | White  | -                                    | RSRAS305-34-10-C              | RSRAS305-34-10-4                |

A  
B  
C  
D  
E  
F  
G  
H  
I  
J  
K  
L  
M  
N  
O  
P  
Q  
R  
S  
T  
U  
V  
W  
X  
Y

A  
B  
C  
D  
E  
F  
G  
H  
I  
J  
K  
L  
M  
N  
O  
P  
Q  
R  
S  
T  
U  
V  
W  
X  
Y

## PLASTIC SHELF SUPPORTS



### Plastic Locking Shelf Support 5mm & 1/4" Bores



- Shelves snap into the Gripper support, which locks and holds them firmly in place
- Ridged stems prevent loosening, and take heavy loads
- Peg length: 8mm
- Shelf rest area is 1-3/4"L x 1/2"W (NB426BN-3/4, NB426CL-3/4), 1-1/2"L x 1/2"W (NB426CL-5/8, NB426BN-5/8), 1-7/16"L x 1/2"W (NB526CL-3/4, NB526BN-3/4)
- Low profiles make GRIPPER supports ideal for frameless cabinet styles
- Sold in full box quantity

| For Use With | Finish | 1/4" Bore<br>Box Qty: 100<br>Item# | 1/4" Bore<br>Box Qty: 1,000<br>Item# | 5mm<br>Box Qty: 100<br>Item # | 5mm<br>Box Qty: 1,000<br>Item # |
|--------------|--------|------------------------------------|--------------------------------------|-------------------------------|---------------------------------|
| 5/8" Shelves | Brown  | NB426BN-5/8-C                      | NB426BN-5/8                          | -                             | -                               |
| 3/4" Shelves | Clear  | -                                  | -                                    | NB526CL-3/4-C                 | -                               |
| 3/4" Shelves | Brown  | NB426BN-3/4-C                      | NB426BN-3/4                          | NB526BN-3/4-C                 | NB526BN-3/4                     |
| 3/4" Shelves | Beige  | -                                  | -                                    | NB526BG-3/4-C                 | NB526BG-3/4                     |
| 3/4" Shelves | White  | -                                  | -                                    | NB526WH-3/4-C                 | -                               |



### 5mm Bore Double Pins, Plastic



- Double lock design allows shelf support to accept, support and lock in 3/4" and 1" thick shelves
- Dual 5mm diameter pins are 32mm c/c
- Shelf rest area is 1"L x 1/2"W
- ANSI/BHMA tested and certified
- Sold in full box quantity

| Finish | Item#      | Box Qty |
|--------|------------|---------|
| White  | PL5030-010 | 100     |
| Clear  | PL5030-095 | 100     |



### "L" Shaped Plastic Shelf Support 5mm Bore



- Shelf rest area is 1/2"L x 9/16"W
- 5mm bore, non-fluted 3/8" long stem
- Sold in full box quantity

| Color | Box Qty: 100<br>Item# | Box Qty: 1,000<br>Item # |
|-------|-----------------------|--------------------------|
| Clear | PGH802CL-C            | PGH802CL                 |

**PLASTIC SHELF SUPPORTS**



**"L" Shaped Plastic Shelf Support  
1/4" Bore, Heavy Duty**



- "L" shaped supports have 1/2" long and 1/2" wide shelf rest area
- Pin length is 5/16" and is fluted
- Sold in full box quantity

| Finish     | Item #    | Box Qty |
|------------|-----------|---------|
| Almond     | PGH627A   | 1,000   |
| Dark Brown | PGH627WAL | 1,000   |
| White      | PGH627WH  | 1,000   |



**Nylon Shelf Pins & Shelf Hold-Down, 5mm Bore**



- Fits 5mm diameter hole in 32mm system
- May be used in pin holes one above and one below shelf
- Locks shelf into place for transport
- Made of White Nylon
- Sold in full box quantity

| Item#  | Box Qty |
|--------|---------|
| CN5638 | 500     |



**Shelf Supports, Translucent Plastic**



- 5mm diameter bore
- For shelf thickness 16mm and 19mm
- Holds shelf firmly in place
- Sold in full box quantity

| Item#     | Box Qty |
|-----------|---------|
| HT1005082 | 1,000   |



**Wire Shelf Support  
1/8" Bore**



- Makes shelves adjustable and removable, yet strong and firm
- Drill a series of 1/8" diameter holes x 1/2" deep in the side wall, horizontally separated according to the wire selected and the shelf depth
- Sold in full box quantity

| Length  | Item #          | Box Qty | Item #        | Box Qty |
|---------|-----------------|---------|---------------|---------|
| 6-1/4"  | CNX520-6-1/4-L  | 50      | CNX520-6-1/4  | 250     |
| 7-3/4"  | CNX520-7-3/4-L  | 50      | CNX520-7-3/4  | 250     |
| 9-3/4"  | CNX520-9-3/4-L  | 50      | CNX520-9-3/4  | 250     |
| 13-3/4" | CNX520-13-3/4-L | 50      | CNX520-13-3/4 | 250     |

A  
B  
C  
D  
E  
F  
G  
H  
I  
J  
K  
L  
M  
N  
O  
P  
Q  
R  
S  
T  
U  
V  
W  
X  
Y

A  
B  
C  
D  
E  
F  
G  
H  
I  
J  
K  
L  
M  
N  
O  
P  
Q  
R  
S  
T  
U  
V  
W  
X  
Y

## GLASS SHELF SUPPORTS



### Non-Skid Glass Shelf Support, 5mm Bore

- Nickel-plated steel shelf support with anti-skid rubber treads to keep glass in place
  - Shank is 5mm diameter by 9mm long permitting entry into a 3/4" sidewall from both sides
  - Shelf rest area extends 3/8" and has three rubber donuts to protect glass from scratching
- Packing: As shown below.  
Sold In: Full box quantities only.



| Item#  | Finish        | Box Qty |
|--------|---------------|---------|
| CN1391 | Nickel Plated | 3,000   |



### Non-Skid Glass Shelf Support, 5mm Bore

- Support flat-type shelf rest with 7/16" dia. nylon suction cup for sliding glass
- Pin is 5mm dia. x 9mm L permitting entry from both sides of a 3/4" sidewall
- Projection is 11/16"
- Sold in full box quantity



| Item# | Finish        | Box Qty |
|-------|---------------|---------|
| CN138 | Nickel Plated | 50      |



### Clamping Glass Shelf Support, 5mm Bore

- Metal support that locks glass firmly into place via a rubber tipped nylon screw
- Accommodates glass shelf thickness of 3/16" to 1/4"
- Can also be used as a pivot hinge with 3/8" diameter plastic bushing
- 5mm bore pin is 5/16" long
- Support holding shelf is 3/4" square
- Available in two finishes: brass and chrome



Packing: As shown below.  
Sold In: Full box quantities only.

| Finish | Box Qty: 50 Item# | Box Qty: 500 Item # |
|--------|-------------------|---------------------|
| Brass  | CN301521BR-L      | -                   |
| Chrome | CN301521CHR-L     | CN301521CHR         |

## HANGING RAIL SYSTEMS



### 280 Lb. Rated Hanging Rail System Cover Cap Required Brackets & Suspension Rail



- Grass suspension brackets are handed (left or right) and are 100% steel construction
- Brackets are rated at 280 lbs. per pair
- Suspension rail is 8' L with unique hole pattern design make 16" on center studs easy to locate



| Brackets, Suspension Rail and Cover Caps |                          |                           |                    |
|--|--------------------------|---------------------------|--------------------|
| Material / Color                         | Left Hand Bracket Item # | Right Hand Bracket Item # | Closet Rail Item # |
| Handed Brackets                          | GFF155145068233          | GFF155145067233           | -                  |
| Suspension Rail 8' L                     | -                        | -                         | ME499.830.00.1719  |
| White Cover Cap                          | ME514.825.40.1274        | ME514.825.40.1174         | ME499.831.00.0174  |
| Almond Cover Cap                         | ME514.825.40.1253        | ME514.825.40.1153         | -                  |
| Brown Cover Cap                          | ME514.825.40.1258        | ME514.825.40.1158         | ME499.831.00.0158  |
| Black Cover Cap                          | ME514.825.40.1262        | ME514.825.40.1162         | -                  |

### 180 Lb. Rated Hanging Rail System

- Steel Hanging Rail with oval holes
- Brackets are rated at 180 lbs. per pair
- Brackets Left/Right adjustment is 11mm, Up/Down adjustment is 14mm



|   | Item#          | Description  |
|---|----------------|--|
| A | CM875-Z1-24    | Steel Hanging Rail with oval holes, 1"W x 93-3/8"L     |
| B | CM883-01-24    | Cover for 1" Steel Hanging Rail, White                 |
|   | CM883-55-24    | Cover for 1" Steel Hanging Rail, Almond                |
|   | CM883-04-24    | Cover for 1" Steel Hanging Rail, Brown                 |
| C | CM16-85450     | Hanging Rail Bracket, Left Sided, Zinc plated          |
| D | CM16-85451     | Hanging Rail Bracket, Right Sided, Zinc plated         |
| E | CM16-85252-680 | Cover Cap for Hanging Rail Bracket, Left Sided, White  |
|   | CM16-85253-680 | Cover Cap for Hanging Rail Bracket, Right Sided, White |

A  
B  
C  
D  
E  
F  
G  
H  
I  
J  
K  
L  
M  
N  
O  
P  
Q  
R  
S  
T  
U  
V  
W  
X  
Y

## ROUND CLOSET TUBING

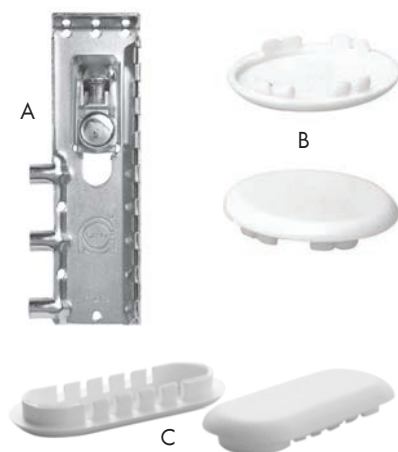

### Concealed Metal Hanging Bracket & Cover Cap



- Primary use for kitchen cabinets
  - Mounts behind back panel
  - 286 lbs. weight capacity per pair
  - Adjustment: 10mm Left to Right / 12mm Up and Down
- Sold In: Both broken and full box quantities.

|                   | Item#       | Description   |
|-------------------|-------------|---|
| A                 | CM816-DU-DX | Concealed Bracket, Right Side Mount                       |
|                   | CM816-DU-SX | Concealed Bracket, Left Side Mount                        |
| <b>Cover Caps</b> |             |   |
| B                 | CM810-35-01 | 40mm Round Cover Cap, White Finish, for 816 Bracket       |
| C                 | CM810-00-01 | 40mm x 20mm Oval Cover Cap, White Finish, for 816 Bracket |



### 1-1/16" Diameter Round Chrome Tubing



- Wall thickness of .075"
- Chrome Look finish

| Item #    | Length | Item #     | Length |
|-----------|--------|------------|--------|
| KV7501-72 | 6 ft.  | KV7501-120 | 10 ft. |
| KV7501-96 | 8 ft.  | KV7501-144 | 12 ft. |



### 1-1/16" Diameter Round Tubing Heavy Duty, Stainless Steel



- .087" (2.2mm) wall thickness
- Stainless steel skin over steel

| Item #     | Length | Item #      | Length |
|------------|--------|-------------|--------|
| KV660SS-48 | 4 ft.  | KV660SS-96  | 8 ft.  |
| KV660SS-60 | 5 ft.  | KV660SS-120 | 10 ft. |
| KV660SS-72 | 6 ft.  | KV660SS-144 | 12 ft. |



### 1-1/16" Diameter Round Tubing Extra Heavy Duty, Thick Wall Tubing



- Chrome Look finish
- Extra thick wall thickness of .106"

| Item#     | Length | Item#      | Length |
|-----------|--------|------------|--------|
| KV7701-72 | 6 ft.  | KV7701-120 | 10 ft. |
| KV7701-96 | 8 ft.  | KV7701-144 | 12 ft. |

**ROUND CLOSET TUBING & FLANGES**



**1-1/16" Diameter Round Chrome Tubing  
Value Priced Steel**



- High quality steel with a wall thickness of .080"
- Material is 14 gauge steel with Polished Chrome finish

| Item#          | Length |
|----------------|--------|
| UF53431-46-017 | 4 ft.  |
| UF53431-46-030 | 5 ft.  |
| UF53431-46-031 | 6 ft.  |

| Item#          | Length |
|----------------|--------|
| UF53431-46-008 | 8 ft.  |
| UF53431-46-032 | 10 ft. |
| UF53431-46-006 | 12 ft. |



Closed

Open

**1-1/16" Diameter Chrome Flanges  
Value Priced Round Open & Closed Style**



- Flange is made of steel
- Three screw hole design (sold without screws)

| Item#          | Flange Type | Finish          |
|----------------|-------------|-----------------|
| UF54133-46-019 | Open        | Polished Chrome |
| UF54233-46-028 | Closed      |                 |

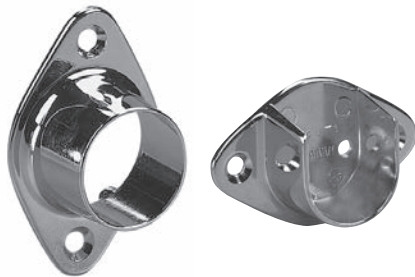

**1-1/16" Dia. Flange, Round Open & Closed Style**



- For 1-1/16" OD tubing
- Made of steel
- Screw holes 2" on center, screws included

| Item#     | Flange Type | Finish      |
|-----------|-------------|-------------|
| KV734CHR  | Closed      | Chrome-look |
| KV735-CHR | Open        |             |



**1-1/16" Dia. Chrome Flange, Round Open w/Pins**



- For 1-1/16" OD tubing
- 2 pins 32mm on center for 5mm bore holes
- 1 hole for screw mount, screws included

| Item#    | Finish      |
|----------|-------------|
| KV632CHR | Chrome Look |



**1-1/16" Dia. Flange,  
Round Three Position Open Style**



- Made of steel, Anochrome finish
- Allows for on-the-spot adjustment of closet rod height
- Three screw holes positioned inside of flange, with screws
- For use with 1-1/16" outer diameter tubing

| Item#     | Finish    |
|-----------|-----------|
| KV742-CHR | Anochrome |

Packing: 12 each per box, screws included.

A  
B  
C  
D  
E  
F  
G  
H  
I  
J  
K  
L  
M  
N  
O  
P  
Q  
R  
S  
T  
U  
V  
W  
X  
Y

**A ROUND CLOSET TUBING**



**1-5/16" Diameter Round Chrome Tubing**

- Wall thickness: .075"
- Available in four lengths
- Made of steel, Chrome Look finish



| Length | Item #    |
|--------|-----------|
| 6 ft.  | KV7505-72 |
| 8 ft.  | KV7505-96 |

| Length | Item #     |
|--------|------------|
| 10 ft. | KV7505-120 |
| 12 ft. | KV7505-144 |



**1-5/16" Diameter Round Chrome Tubing Heavy Duty, Thick Wall**

- Extra wall thickness of 1.06"
- Available in four lengths
- Steel construction



| Length | Item #    |
|--------|-----------|
| 6 ft.  | KV7705-72 |
| 8 ft.  | KV7705-96 |

| Length | Item #     |
|--------|------------|
| 10 ft. | KV7705-120 |
| 12 ft. | KV7705-144 |



**1-5/16" Diameter Round Tubing, Value Priced**

- Wall thickness .078"



| Item#          | Length | Finish            | Material |
|----------------|--------|-------------------|----------|
| UF53435-47-024 | 8 ft.  | Dull Brass        | Aluminum |
| UF53435-48-025 | 8 ft.  | Dull Chrome       | Aluminum |
| UF53435-49-026 | 8 ft.  | Dull Nickel       | Aluminum |
| UF53435-51-023 | 8 ft.  | Matte Black       | Aluminum |
| UF53435-53-027 | 8 ft.  | Oil Rubbed Bronze | Aluminum |

| Item#          | Length | Finish          | Material |
|----------------|--------|-----------------|----------|
| UF53431-46-033 | 4 ft.  | Polished Chrome | Steel    |
| UF53431-46-034 | 5 ft.  | Polished Chrome | Steel    |
| UF53431-46-035 | 6 ft.  | Polished Chrome | Steel    |
| UF53431-46-015 | 8 ft.  | Polished Chrome | Steel    |
| UF53431-46-036 | 10 ft. | Polished Chrome | Steel    |
| UF53431-46-014 | 12 ft. | Polished Chrome | Steel    |



**1-5/16" Diameter Flanges, Open & Closed**

- Flanges are made of a zinc alloy
- Holds a 1-5/16" dia. outside dimension tube
- Flanges have three screw holes (screws not included)



| Open Item#     | Finish            | Type |
|----------------|-------------------|------|
| UF54133-49-022 | Dull Nickel       | Open |
| UF54133-48-042 | Dull Chrome       | Open |
| UF54133-47-043 | Dull Brass        | Open |
| UF54133-51-044 | Matte Black       | Open |
| UF54133-53-077 | Oil Rubbed Bronze | Open |
| UF54133-46-021 | Polished Chrome   | Open |

| Closed Item#   | Finish            | Type   |
|----------------|-------------------|--------|
| UF54233-49-088 | Dull Nickel       | Closed |
| UF54233-48-034 | Dull Chrome       | Closed |
| UF54233-47-035 | Dull Brass        | Closed |
| UF54233-51-036 | Matte Black       | Closed |
| UF54233-53-075 | Oil Rubbed Bronze | Closed |
| UF54233-46-027 | Polished Chrome   | Closed |

A  
B  
C  
D  
E  
F  
G  
H  
I  
J  
K  
L  
M  
N  
O  
P  
Q  
R  
S  
T  
U  
V  
W  
X  
Y



## ROUND CLOSET FLANGES



### 1-5/16" Diameter Flanges Round Open & Closed With Pins



- Flanges are made of a zinc alloy
- Holds a 1-5/16" diameter outside dimension tube
- Flange has two pins, 32mm on center for 5mm bore holes and center screw hole,

| Open Item#     | Finish            | Type |
|----------------|-------------------|------|
| UF54131-49-083 | Dull Nickel       | Open |
| UF54131-48-046 | Dull Chrome       | Open |
| UF54131-47-047 | Dull Brass        | Open |
| UF54131-51-048 | Matte Black       | Open |
| UF54131-53-090 | Oil Rubbed Bronze | Open |
| UF54131-46-058 | Polished Chrome   | Open |

| Closed Item#   | Finish          | Type   |
|----------------|-----------------|--------|
| UF54231-49-076 | Dull Nickel     | Closed |
| UF54231-48-038 | Dull Chrome     | Closed |
| UF54231-47-039 | Dull Brass      | Closed |
| UF54231-51-040 | Matte Black     | Closed |
| UF54231-53-041 | Oil Rub Bronze  | Closed |
| UF54231-46-089 | Polished Chrome | Closed |

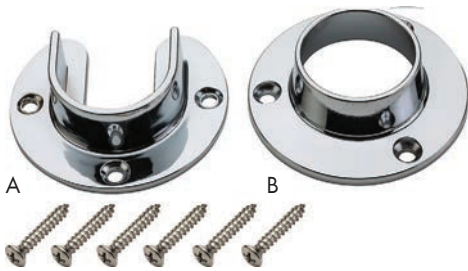

### 1-5/16" Dia. Chrome Flanges, Open & Closed



- For 1-5/16" tubing
- Chrome look finish
- Includes screws

|   | Item#     | Type   | Holes                                |
|---|-----------|--------|--------------------------------------|
| A | KV766-CHR | Open   | 2-Holes on 2-1/4" centers, on at 90° |
| B | KV764-CHR | Closed | 3-Holes spaced 1-1/8" from center    |

### 1-5/16" Diameter Flanges, Open & Closed Pair Set



- Includes: 1 Open type, 1 Closed type
  - Material/Finish: Steel, Polished Brass
- Packing: 12 sets per box, screws included.  
Sold In: Both broken and full box quantities.

| Item#    |
|----------|
| LC505SBR |



### Closet Tubing, Round End Caps

- Anochrome finish



| Item#     | Description                 |
|-----------|-----------------------------|
| KV730-ANO | Fits KV# 660 Tubing         |
| KV731-ANO | Fits tubing with 1-1/16" OD |
| KV732-ANO | Fits tubing with 1-5/16" OD |

**A OVAL CLOSET TUBING**

B  
C  
D  
E  
F  
G  
H  
I  
J  
K  
L  
M  
N  
O  
P  
Q  
R  
S  
T  
U  
V  
W  
X  
Y



**Oval Chrome Tubing, 30mm x 15mm  
Value Priced, Steel**



- Tubing is made of steel with a Polished Chrome finish
  - .039" Wall Thickness
  - Available in 8' and 12' lengths
- Packing: 20 each per box.  
Sold In: Both broken and full box quantities.

| Item#          | Length            |
|----------------|-------------------|
| UF53111-46-003 | 8 ft. Closet Rod  |
| UF53111-46-001 | 12 ft. Closet Rod |



**Oval Tubing, 30mm x 15mm  
Aluminum, Varied Finishes**



- Tubing is made of 100% aluminum
  - .039" wall thickness
  - Available in 8' lengths only
- Packing: 20 each per box.  
Sold In: Both broken and full box quantities.

| Item#          | Finish      |
|----------------|-------------|
| UF53315-47-019 | Dull Brass  |
| UF53315-48-020 | Dull Chrome |
| UF53315-49-021 | Dull Nickel |

| Item#          | Finish            |
|----------------|-------------------|
| UF53315-51-018 | Matte Black       |
| UF53315-53-022 | Oil Rubbed Bronze |

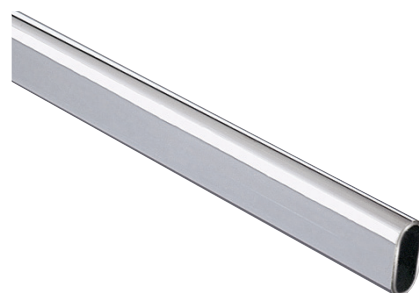

**Oval Chrome Tubing, 30mm x 15mm  
Heavy Duty, Steel**



- Wall Thickness .047"
  - Constructed of steel with a heavy gauge welded seam
  - Chrome Look finish
- Packing: 10 per box.  
Sold In: Both broken and full box quantities.

| Item#        | Length |
|--------------|--------|
| KV880CHR-96  | 8 ft.  |
| KV880CHR-144 | 12 ft. |



**Center Support for Oval Tubing**



- Size: 9/16" x 1-3/16"
- For oval tubing: 1-1/8" x 5/8" (30mm x 15mm)
- For oval tubing part# UF53111-46-003 8'L or UF53111-46-001 12'L
- (2) holes for mounting screws, 1-3/16" C/C
- Includes #6 x 3/4" screws

| Item#          | Description                                | Finish |
|----------------|--|--------|
| UF54215-46-079 | Center Support for 30mm x 15mm Oval Tubing | Chrome |

**OVAL CLOSET FLANGES**



**Oval Flange, 30mm X 15mm  
Open Style, 3 Hole/No Pins**



- Flanges are made of a zinc alloy
  - Flanges have 3 screw holes with no pins
- Packing: 50 per box, screws not included.  
Sold In: Both broken and full box quantities

| Item#          | Finish            |
|----------------|-------------------|
| UF54113-49-084 | Dull Nickel       |
| UF54113-48-091 | Dull Chrome       |
| UF54113-47-054 | Dull Brass        |
| UF54113-51-055 | Matte Black       |
| UF54113-53-085 | Oil Rubbed Bronze |
| UF54113-46-013 | Polished Chrome   |



**Oval Flange, 30mm x 15mm  
Open Style With Dual Pins**



- Flanges are made of a zinc alloy
  - Flanges have two 5mm pins for use in 32mm systems and a single screw hole
- Packing: 50 per box, screws not included.  
Sold In: Both broken and full box quantities

| Item#          | Finish            |
|----------------|-------------------|
| UF54111-49-086 | Dull Nickel       |
| UF54111-48-078 | Dull Chrome       |
| UF54111-47-051 | Dull Brass        |
| UF54111-51-052 | Matte Black       |
| UF54111-53-008 | Oil Rubbed Bronze |



**Oval Chrome Flanges, 30mm x 15mm  
Open Style With Dual Pins**



- For use with KV880 Series or other 30mm x 15mm oval tubing
  - Designed with 1 hole for extra mounting strength; two 5mm pins for use in 32mm systems
  - Chrome Look finish
- Packing: 50 per box, screws not included.  
Sold In: Both broken and full box quantities.

| Item#     | Finish |
|-----------|--------|
| KV881-CHR | Chrome |

A  
B  
C  
D  
E  
F  
G  
H  
I  
J  
K  
L  
M  
N  
O  
P  
Q  
R  
S  
T  
U  
V  
W  
X  
Y

**A CLOSET TUBING FLANGES & CENTER SUPPORTS**

**B**  
**C**  
**D**  
**E**  
**F**  
**G**  
**H**  
**I**  
**J**  
**K**  
**L**  
**M**  
**N**  
**O**  
**P**  
**Q**  
**R**  
**S**  
**T**  
**U**  
**V**  
**W**  
**X**  
**Y**



**1-3/8" Diameter Round Plastic Flanges  
Open & Closed Pair Set, No Pins**

- 1-3/8" White plastic flange



|              |
|--------------|
| <b>Item#</b> |
| PL1323       |



**Round Wood Flanges  
1-3/8" Diameter, Open & Closed Set**

- For 1-3/8" diameter wood poles
- Material/Finish: Unfinished New England Hardwood
- Sets include: (1) open flange and (1) closed flange (set includes screws)



|              |
|--------------|
| <b>Item#</b> |
| SBXF100-138  |



**Closet Rod Center Support  
Hanger for 2" Diameter Rods**

- Use for additional center support on closet rods up to 2" diameter
- Can be used with KV2ZC-72 and KV2ZC-96 expandable rods
- Anochrome finish, screws included



|              |
|--------------|
| <b>Item#</b> |
| KV29201A     |



**Closet Rod Center Support**

- Flange at top of rod is designed to accept 1-1/16" outside diameter tubing
- Support is 24" long but can be cut shorter
- Use for ceiling or under shelf support and added center support for long rods
- Anochrome finish, screws included



|              |
|--------------|
| <b>Item#</b> |
| KV760A       |

## CLOSET EXTENSION HANGERS

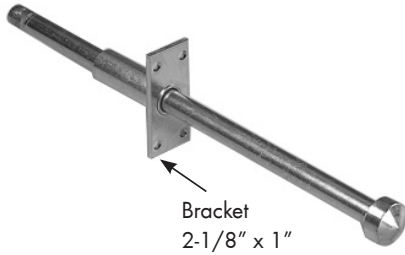

Bracket  
2-1/8" x 1"

### Inset Mount Rod

- .43" diameter rod
- Anochrome finish, screws included
- Extends 5/8" to 8-1/4", overall length is 10-5/16"
- Total clearance needed is 9.695"



| Item#  | Bore Length |
|--------|-------------|
| KV753A | 2-1/16"     |



### Expandable Closet Tubing

- Expandable Steel round tubing, no need to cut
- Top tabs sit on shelf cleat for easy alignment
- Screws included



| Length Range | White Item# | Zinc Item # |
|--------------|-------------|-------------|
| 18"- 30"     | KV2WH-18    | KV2ZC-18    |
| 30"- 48"     | KV2WH-30    | KV2ZC-30    |
| 48"- 72"     | KV2WH-48    | KV2ZC-48    |
| 60"- 96"     | -           | KV2ZC-60    |
| 72"-120"     | -           | KV2ZC-72    |
| 96"-144"     | -           | KV2ZC-96    |



### Extension Hanger, Ball Bearing Movement

- Ball bearing movement
- Extension hanger designed to mount perpendicularly underneath closet shelving
- Increases accessibility and closet capacity
- Garments are more accessible
- Anochrome finish



| Item#  | Fits Shelf Size | Length of Extension |
|--------|-----------------|---------------------|
| KV1-10 | 10" Only        | 10"                 |
| KV1-12 | 12"-16" Wide    | 12"                 |
| KV1-16 | 16"-20" Wide    | 16"                 |
| KV1-20 | 20"-24" Wide    | 20"                 |

A  
B  
C  
D  
E  
F  
G  
H  
I  
J  
K  
L  
M  
N  
O  
P  
Q  
R  
S  
T  
U  
V  
W  
X  
Y

## VALET RODS



### Valet Rods, Standard Outside Mount



- 12" depth standard valet rod mounts via 32mm hole pattern
- Rod extends 6"
- Requires only 4 screws to install, included
- Features a removable pull for easy customization

| Item #       | Finish            |
|--------------|-------------------|
| RSCVL-12-CR  | Chrome            |
| RSCVL-12-ORB | Oil Rubbed Bronze |
| RSCVL-12-SN  | Satin Nickel      |

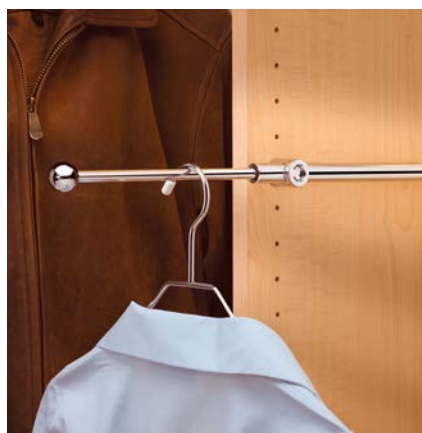

### Valet Rods, Decorative Outside Mount Rod



- Designed for 12" or 14" depth closet panels, mounts within 32mm hole patterns
- 12" depth rod extends 6" fully opened and 14" depth rod extends 8" fully opened
- Features a removable pull for changing out hardware
- Requires only 2 Euro screws to install (included)
- Adjustable mounting brackets included

| 12" Depth Item # | 14" Depth Item# | Finish            |
|------------------|-----------------|-------------------|
| RSCVR-12-CR      | RSCVR-14-CR     | Chrome            |
| RSCVR-12-ORB     | RSCVR-14-ORB    | Oil Rubbed Bronze |
| RSCVR-12-SN      | RSCVR-14-SN     | Satin Nickel      |



### Valet Rods, Inset Mount Rod



- Rod is 7-3/8" long, designed to fit 3/4" thick or thicker panels
- Rod extends 3-1/3" fully opened
- Removable pull hardware for easy customization
- Optional drill guide (RSCVRI-DG) guarantees a perfect fit and incomparable stability

| Item #                      | Finish            |
|-----------------------------|-------------------|
| RSCVRI-7-CR                 | Chrome            |
| RSCVRI-7-ORB                | Oil Rubbed Bronze |
| RSCVRI-7-SN                 | Satin Nickel      |
| <b>Optional Drill Guide</b> |                   |
| RSCVRI-DG                   |                   |

**PULL-OUT PANTS RACKS**



**Metal Pants Rack, Pull-Out Rack**



- Made of heavy gauge chrome with moveable fingers and full extension
- 18"W holds 9 pairs of pants and 24"W holds 13 pairs of pants
- Designed for 14"W closet space
- Rack has adjustment feature
- Heavy duty full extension slides are rated at 100 lbs.

| Item#        | Dimensions                      | Finish |
|--------------|---------------------------------|--------|
| RSPSC-1814CR | 17-1/2" - 18-1/8"W x 3"H x 14"D | Chrome |
| RSPSC-2414CR | 23-3/4" - 24-1/2"W x 3"H x 14"D | Chrome |
| RSPSC-3014CR | 29-3/4" - 30-1/2"W x 3"H x 14"D | Chrome |



**Metal Pants Rack, Fan Style**



- Chrome plated fan rack has a distinctive fan feature with fingers
- Fan pants rack is made for 18" wide and 16" depth closet opening
- Can be mounted either right or left handed
- Rubber o-rings keep pants from slipping, polished ends prevent snags

| Item#           | Dimensions          | Finish            |
|-----------------|---------------------|-------------------|
| RSCPRF-16CR-52  | 16-1/8"W x 16-1/8"D | Chrome            |
| RSCPRF-16ORB-52 | 16-1/8"W x 16-1/8"D | Oil Rubbed Bronze |
| RSCPRF-16SN-52  | 16-1/8"W x 16-1/8"D | Satin Nickel      |



**Pull-Out Wood Pant Rack**



- Available in 24" and 30" widths
- Space for up to 18 standard pants
- 100 lbs. full-extension slides, rubber grommets to prevent slipping and removable rods
- 30" wide pants rack has space for tie storage
- Made from solid Birch/Maple

| Item#         | Dimensions              |
|---------------|-------------------------|
| RSCWPR-2414-1 | 24" W x 14-3/8"D x 6" H |

A  
B  
C  
D  
E  
F  
G  
H  
I  
J  
K  
L  
M  
N  
O  
P  
Q  
R  
S  
T  
U  
V  
W  
X  
Y

**A PULL-OUT TIE/BELT RACKS**

B  
C  
D  
E  
F  
G  
H  
I  
J  
K  
L  
M  
N  
O  
P  
Q  
R  
S  
T  
U  
V  
W  
X  
Y



**Tie Rack With Top Tray**



- Holds up to 20 ties, 5 belts and 4 peg closure belts
- Top tray for accessories
- Designed to mount to closet side panels and extends via ball bearing slide

| Item#       | Dimensions       | Finish |
|-------------|------------------|--------|
| RSTBC-14TCR | 6"W x 14"D x 5"H | Chrome |

**Steel Side Mount Tie/Belt Rack**



- Made of Steel w/full extension ball bearing slides
- Available in 12"D & 14"D

Sold In: Both broken full box quantities.



| Item#                           | Size                     | Finish            | Belt/Tie Capacity |
|---------------------------------|--------------------------|-------------------|-------------------|
| <b>Steel Pull-Out Belt Rack</b> |                          |                   |                   |
| RSBRC-12CR                      | 2-1/2"W x 12"D x 1-7/8"H | Chrome            | 7 Belt Hooks      |
| RSBRC-12ORB                     | 2-1/2"W x 12"D x 1-7/8"H | Oil Rubbed Bronze | 7 Belt Hooks      |
| RSBRC-12SN                      | 2-1/2"W x 12"D x 1-7/8"H | Satin Nickel      | 7 Belt Hooks      |
| RSBRC-14CR                      | 2-1/2"W x 14"D x 1-7/8"H | Chrome            | 9 Belt Hooks      |
| RSBRC-14ORB                     | 2-1/2"W x 14"D x 1-7/8"H | Oil Rubbed Bronze | 9 Belt Hooks      |
| RSBRC-14SN                      | 2-1/2"W x 14"D x 1-7/8"H | Satin Nickel      | 9 Belt Hooks      |
| <b>Steel Pull-Out Tie Rack</b>  |                          |                   |                   |
| RSTRC-12CR                      | 2-1/2"W x 12"D x 1-7/8"H | Chrome            | 23 Ties           |
| RSTRC-12ORB                     | 2-1/2"W x 12"D x 1-7/8"H | Oil Rubbed Bronze | 23 Ties           |
| RSTRC-12SN                      | 2-1/2"W x 12"D x 1-7/8"H | Satin Nickel      | 23 Ties           |
| RSTRC-14CR                      | 2-1/2"W x 14"D x 1-7/8"H | Chrome            | 25 Ties           |
| RSTRC-14ORB                     | 2-1/2"W x 14"D x 1-7/8"H | Oil Rubbed Bronze | 25 Ties           |
| RSTRC-14SN                      | 2-1/2"W x 14"D x 1-7/8"H | Satin Nickel      | 25 Ties           |



## PULL-OUT WOOD TIE RACKS



### Wood Pull-Out Tie Rack



- Wood pull-out rack can hold over 120 ties
- Features 100 lb. full extension slides and rubber o-rings to prevent slipping
- Made from solid birch/maple

| Item#         | Dimensions             |
|---------------|------------------------|
| RSCWTR-2414-1 | 24" W x 14-3/8"D x 6"H |



### Wood Tie Butler, Top Mount



- Made of Maple with ball bearing slides and fits in min of 5-1/4" opening

| Item #       | Finish  | Depth | Tie Capacity |
|--------------|---------|-------|--------------|
| RSCWTR-12-1  | Natural | 12"   | 38           |
| RSCWTR-12B-1 | Black   | 12"   | 38           |
| RSCWTR-14-1  | Natural | 14"   | 44           |
| RSCWTR-14B-1 | Black   | 14"   | 44           |
| RSCWTR-16-1  | Natural | 16"   | 52           |
| RSCWTR-20-1  | Natural | 20"   | 68           |



### Wood Tie Racks, Side Mount



- Made of Maple with full extension ball bearing slides

| Item #        | Finish  | Depth | Tie Capacity |
|---------------|---------|-------|--------------|
| RSCWSTR-12-1  | Natural | 12"   | 19           |
| RSCWSTR-14-1  | Natural | 14"   | 22           |
| RSCWSTR-14B-1 | Black   | 14"   | 22           |
| RSCWSTR-14W-1 | White   | 14"   | 22           |
| RSCWSTR-20-1  | Natural | 20"   | 34           |



### Reverse Mounting Bracket



- Designed for unused space between the wall and the end of the run
- Unique design works with all Rev-A-Shelf tie/belt racks

| Item#         | Dimensions       | Finish |
|---------------|------------------|--------|
| RSCRMB-12CR-5 | 3-3/4" W x 11" D | Chrome |

A  
B  
C  
D  
E  
F  
G  
H  
I  
J  
K  
L  
M  
N  
O  
P  
Q  
R  
S  
T  
U  
V  
W  
X  
Y

A  
B  
C  
D  
E  
F  
G  
H  
I  
J  
K  
L  
M  
N  
O  
P  
Q  
R  
S  
T  
U  
V  
W  
X  
Y

## BELT & TIE RACKS



### Side Mount Wood Belt Rack



- Designed for 3" wide spaces
- Full-extension slides
- Removable Pegs
- Carb II compliant

| Item#        | Description                                       | Finish  |
|--------------|---|---------|
| RSCWSBR-14-1 | 2-3/4"W x 13-7/8"D x 2-7/8"H, Capacity = 17 Belts | Natural |
| RSCWSBR-20-1 | 2-3/4"W x 19-7/8"D x 2-7/8"H, Capacity = 23 Belts | Natural |



### Top Mount Wood Belt Butler



- Holds up to 26 Belts
- Durable wood construction
- Full-extension slides
- Removable Pegs
- Carb II compliant

| Item#         | Description                                       | Finish |
|---------------|---|--------|
| RSCWTBR-14B-1 | 4-1/2"W x 13-7/8"D x 3-3/8"H, Capacity = 26 Belts | Black  |

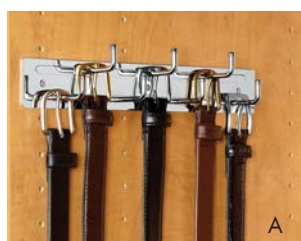

### Static Racks



- Available in Chrome, Oil Rubbed Bronze and Satin Nickel
- Easy installation

|                         | Item#          | Description      | Size                         | Capacity | Finish            |
|-------------------------|----------------|------------------|------------------------------|----------|-------------------|
| <b>Static Belt Rack</b> |                |                  |                              |          |                   |
| A                       | RSBRC-12NS-CR  | Static Belt Rack | 1-7/8"W x 11-3/4"D x 1-3/4"H | 7 Belts  | Chrome            |
|                         | RSBRC-12NS-ORB | Static Belt Rack | 1-7/8"W x 11-3/4"D x 1-3/4"H | 7 Belts  | Oil Rubbed Bronze |
|                         | RSBRC-12NS-SN  | Static Belt Rack | 1-7/8"W x 11-3/4"D x 1-3/4"H | 7 Belts  | Satin Nickel      |
| <b>Static Tie Rack</b>  |                |                  |                              |          |                   |
| B                       | RSTRC-12NS-CR  | Static Tie Rack  | 1-7/8"W x 11-3/4"D x 1-3/4"H | 23 Ties  | Chrome            |
|                         | RSTRC-12NS-ORB | Static Tie Rack  | 1-7/8"W x 11-3/4"D x 1-3/4"H | 23 Ties  | Oil Rubbed Bronze |
|                         | RSTRC-12NS-SN  | Static Tie Rack  | 1-7/8"W x 11-3/4"D x 1-3/4"H | 23 Ties  | Satin Nickel      |

**SPIRAL CLOTHES RACK & PULL DOWN CLOSET ROD**



**Spiral Clothes Rack**



- 360-degree turning radius
- Adjustable Height: 72-1/2" to 84"
- Can hang (40) single items of clothing
- Comes complete with a stabilizer bar, post and pivot hardware and mounting hardware
- Weight capacity: 130 lbs. when attached to floor

NOTE: The size of your hangers and clothing stored on this unit will dictate the minimum size of the cabinet

| Item#    | Description      | Size                  | Capacity                    | Finish |
|----------|------------------|-----------------------|-----------------------------|--------|
| RSSHR-84 | 360° Spiral Rack | 23"W x 72-1/2" - 84"H | 40 single items of clothing | Chrome |

A  
B  
C  
D  
E  
F  
G  
H  
I  
J  
K  
L  
M  
N  
O  
P  
Q  
R  
S  
T  
U  
V  
W  
X  
Y



**Pull Down Closet Rod,  
25 lbs. Load Capacity**



- The telescoping pull rod's length is adjustable from 34" - 50" to accommodate universal design and handicap accessible applications
- Soft-closing mechanism that will slowly draw the bar back to the upright position
- Includes: (1) Pull-Down Closet assembly, rod, mechanism, arms, handle, connectors and hardware

| Item#        | Cabinet Width Ranges              | Load Capacity | Finish         |
|--------------|-----------------------------------|---------------|----------------|
| RSCPDR-1826  | 18" - 26"W                        | 25 lbs.       | Chrome & Black |
| RSCPDR-2635  | 26" - 35"W                        | 25 lbs.       | Chrome & Black |
| RSCPDR-3548  | 35" - 48"W                        | 25 lbs.       | Chrome & Black |
| RSCPDR-STP-1 | Rod Stop for Pull-Down Closet Rod |               |                |

A  
B  
C  
D  
E  
F  
G  
H  
I  
J  
K  
L  
M  
N  
O  
P  
Q  
R  
S  
T  
U  
V  
W  
X  
Y

## PULL-OUT CLOSET BASKETS



### Premium Heavy Duty Pull-Out Wire Baskets

- Heavy duty slides (100 lb. rated) ball bearing type with bayonet mounting system configured to 32mm system
- Baskets are designed to be easily removable and effortlessly re-installed
- Baskets rest on top of ball bearing slides
- Oil Rubbed Bronze baskets available with black slides for a consistent appearance
- Closet Basket Liners are sold separately on the next page

| Size               | Chrome Item#  | Oil Rubbed Bronze Item# | Satin Nickel Item# |
|--------------------|---------------|-------------------------|--------------------|
| 18"W x 12"D x 7"H  | RSCB-181207CR | -                       | -                  |
| 18"W x 12"D x 11"H | RSCB-181211CR | -                       | -                  |
| 18"W x 12"D x 18"H | RSCB-181218CR | -                       | -                  |
| 18"W x 14"D x 7"H  | RSCB-181407CR | RSCB-181407ORB          | RSCB-181407SN      |
| 18"W x 14"D x 11"H | RSCB-181411CR | RSCB-181411ORB          | RSCB-181411SN      |
| 18"W x 14"D x 18"H | RSCB-181418CR | RSCB-181418ORB          | RSCB-181418SN      |
| 18"W x 16"D x 7"H  | RSCB-181607CR | RSCB-181607ORB          | RSCB-181607SN      |
| 18"W x 16"D x 11"H | RSCB-181611CR | RSCB-181611ORB          | RSCB-181611SN      |
| 18"W x 16"D x 18"H | RSCB-181618CR | RSCB-181618ORB          | RSCB-181618SN      |
| 18"W x 20"D x 7"H  | RSCB-182007CR | RSCB-182007ORB          | RSCB-182007SN      |
| 18"W x 20"D x 11"H | RSCB-182011CR | RSCB-182011ORB          | RSCB-182011SN      |
| 18"W x 20"D x 18"H | RSCB-182018CR | RSCB-182018ORB          | RSCB-182018SN      |
| 24"W x 12"D x 7"H  | RSCB-241207CR | -                       | -                  |
| 24"W x 12"D x 11"H | RSCB-241211CR | -                       | -                  |
| 24"W x 12"D x 18"H | RSCB-241218CR | -                       | -                  |
| 24"W x 14"D x 7"H  | RSCB-241407CR | RSCB-241407ORB          | RSCB-241407SN      |
| 24"W x 14"D x 11"H | RSCB-241411CR | RSCB-241411ORB          | RSCB-241411SN      |
| 24"W x 14"D x 18"H | RSCB-241418CR | RSCB-241418ORB          | RSCB-241418SN      |
| 24"W x 16"D x 7"H  | RSCB-241607CR | RSCB-241607ORB          | RSCB-241607SN      |
| 24"W x 16"D x 11"H | RSCB-241611CR | RSCB-241611ORB          | RSCB-241611SN      |
| 24"W x 16"D x 18"H | RSCB-241618CR | RSCB-241618ORB          | RSCB-241618SN      |
| 24"W x 20"D x 7"H  | RSCB-242007CR | RSCB-242007ORB          | RSCB-242007SN      |
| 24"W x 20"D x 11"H | RSCB-242011CR | RSCB-242011ORB          | RSCB-242011SN      |
| 24"W x 20"D x 18"H | RSCB-242018CR | RSCB-242018ORB          | RSCB-242018SN      |
| 30"W x 12"D x 7"H  | RSCB-301207CR | -                       | -                  |
| 30"W x 12"D x 11"H | RSCB-301211CR | -                       | -                  |
| 30"W x 12"D x 18"H | RSCB-301218CR | -                       | -                  |
| 30"W x 14"D x 7"H  | RSCB-301407CR | RSCB-301407ORB          | RSCB-301407SN      |
| 30"W x 14"D x 11"H | RSCB-301411CR | RSCB-301411ORB          | RSCB-301411SN      |
| 30"W x 14"D x 18"H | RSCB-301418CR | RSCB-301418ORB          | RSCB-301418SN      |
| 30"W x 16"D x 7"H  | RSCB-301607CR | RSCB-301607ORB          | RSCB-301607SN      |
| 30"W x 16"D x 11"H | RSCB-301611CR | RSCB-301611ORB          | RSCB-301611SN      |
| 30"W x 16"D x 18"H | RSCB-301618CR | RSCB-301618ORB          | RSCB-301618SN      |

## PULL-OUT CLOSET BASKET LINERS

### Pull-Out Basket Liners

- Designed for Rev-A-Shelf's Premium Heavy Duty Pull-Out Wire Baskets (RSCB Series)
- Three types of liners: Black, Tan, and Plastic
- Black and Tans Liners attach securely with hook and loop fasteners
- Black and Tans Liners are machine washable



Black Liner



Tan Liner



Plastic Liner

| Size               | Black Liner Item# | Tan Liner Item# | Plastic Liner Item# |
|--------------------|-------------------|-----------------|---------------------|
| 18"W x 12"D x 7"H  | RSCBL-181207-B    | RSCBL-181207-T  |                     |
| 18"W x 12"D x 11"H | RSCBL-181211-B    | RSCBL-181211-T  |                     |
| 18"W x 12"D x 18"H | RSCBL-181218-B    | RSCBL-181218-T  |                     |
| 18"W x 14"D x 7"H  | RSCBL-181407-B    | RSCBL-181407-T  | RSCBM-181407-P      |
| 18"W x 14"D x 11"H | RSCBL-181411-B    | RSCBL-181411-T  | RSCBM-181411-P      |
| 18"W x 14"D x 18"H | RSCBL-181418-B    | RSCBL-181418-T  | RSCBM-181418-P      |
| 18"W x 16"D x 7"H  | RSCBL-181607-B    | RSCBL-181607-T  | RSCBM-181607-P      |
| 18"W x 16"D x 11"H | RSCBL-181611-B    | RSCBL-181611-T  | RSCBM-181611-P      |
| 18"W x 16"D x 18"H | RSCBL-181618-B    | RSCBL-181618-T  | RSCBM-181618-P      |
| 18"W x 20"D x 7"H  | RSCBL-182007-B    | RSCBL-182007-T  |                     |
| 18"W x 20"D x 11"H | RSCBL-182011-B    | RSCBL-182011-T  |                     |
| 18"W x 20"D x 18"H | RSCBL-182018-B    | RSCBL-182018-T  |                     |
| 24"W x 12"D x 7"H  | RSCBL-241207-B    | RSCBL-241207-T  |                     |
| 24"W x 12"D x 11"H | RSCBL-241211-B    | RSCBL-241211-T  |                     |
| 24"W x 12"D x 18"H | RSCBL-241218-B    | RSCBL-241218-T  |                     |
| 24"W x 14"D x 7"H  | RSCBL-241407-B    | RSCBL-241407-T  | RSCBM-241407-P      |
| 24"W x 14"D x 11"H | RSCBL-241411-B    | RSCBL-241411-T  | RSCBM-241411-P      |
| 24"W x 14"D x 18"H | RSCBL-241418-B    | RSCBL-241418-T  | RSCBM-241418-P      |
| 24"W x 16"D x 7"H  | RSCBL-241607-B    | RSCBL-241607-T  | RSCBM-241607-P      |
| 24"W x 16"D x 11"H | RSCBL-241611-B    | RSCBL-241611-T  | RSCBM-241611-P      |
| 24"W x 16"D x 18"H | RSCBL-241618-B    | RSCBL-241618-T  | RSCBM-241618-P      |
| 24"W x 20"D x 7"H  | RSCBL-242007-B    | RSCBL-242007-T  |                     |
| 24"W x 20"D x 11"H | RSCBL-242011-B    | RSCBL-242011-T  |                     |
| 24"W x 20"D x 18"H | RSCBL-242018-B    | RSCBL-242018-T  |                     |
| 30"W x 12"D x 7"H  | RSCBL-301207-B    | RSCBL-301207-T  |                     |
| 30"W x 12"D x 11"H | RSCBL-301211-B    | RSCBL-301211-T  |                     |
| 30"W x 12"D x 18"H | RSCBL-301218-B    | RSCBL-301218-T  |                     |
| 30"W x 14"D x 7"H  | RSCBL-301407-B    | RSCBL-301407-T  | RSCBM-301407-P      |
| 30"W x 14"D x 11"H | RSCBL-301411-B    | RSCBL-301411-T  | RSCBM-301411-P      |
| 30"W x 14"D x 18"H | RSCBL-301418-B    | RSCBL-301418-T  | RSCBM-301418-P      |
| 30"W x 16"D x 7"H  | RSCBL-301607-B    | RSCBL-301607-T  | RSCBM-301607-P      |
| 30"W x 16"D x 11"H | RSCBL-301611-B    | RSCBL-301611-T  | RSCBM-301611-P      |
| 30"W x 16"D x 18"H | RSCBL-301618-B    | RSCBL-301618-T  | RSCBM-301618-P      |

A  
B  
C  
D  
E  
F  
G  
H  
I  
J  
K  
L  
M  
N  
O  
P  
Q  
R  
S  
T  
U  
V  
W  
X  
Y

**A BASKET ACCESSORIES**

**Wire Basket Bracket For Rev-A-Shelf Baskets**



- Top mount bracket allows you to utilize the Rev-A-Shelf wire baskets in non-standard openings of 18", 24", or 30" W
  - Bracket mounts to the underside of cabinet shelf, minimum cabinet opening of 1/2" greater than basket size is required for use
  - Bracket is available in Chrome finish only
- Packing & Sold In: Sets of two brackets only.

| Item#     | Description          |
|-----------|----------------------|
| RSCTMB-18 | For 18" wide baskets |
| RSCTMB-24 | For 24" wide baskets |
| RSCTMB-30 | For 30" wide baskets |

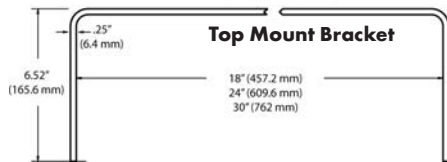

**Cloth Liner For Rev-A-Shelf Wire Baskets**



- Black liner made of durable, machine washable canvas
- Liners feature velcro ties handles
- Provides a comfortable and secure gripping surface
- Liners available for 24" and 30" wide baskets only

| Item#         | Basket Dimensions     | Coordinating RSCB Series Basket |
|---------------|-----------------------|---------------------------------|
| RSCHBI-241418 | 24" W x 14" D x 18" H | RSCB-241418CR & RSCB-241418SN   |
| RSCHBI-241618 | 24" W x 16" D x 18" H | RSCB-241618CR & RSCB-241618SN   |
| RSCHBI-242018 | 24" W x 20" D x 18" H | RSCB-242018CR & RSCB-242018SN   |
| RSCHBI-301418 | 30" W x 14" D x 18" H | RSCB-301418CR & RSCB-301418SN   |
| RSCHBI-301618 | 30" W x 16" D x 18" H | RSCB-301618CR & RSCB-301618SN   |

**TILT-OUT HAMPERS**



**Tilt-Out Hamper Basket, Wire**



- Basket door mounts to a bottom hinged cabinet for easy one step "Slide-In/Slide-Out" basket removal (hinges not included)
- Wire hamper baskets are 19-1/2" H x 13-1/4" D
- Each hamper is constructed with heavy duty 6mm wire
- Provides the ability to conceal and access laundry in one motion
- Includes: Wire tilt-out hamper, hamper attachment brackets and instructions

| Item #             | Dimensions                     | Load Capacity | Finish            |
|--------------------|--------------------------------|---------------|-------------------|
| RSCTOHB-161319CR   | 15-1/2"W x 13-1/2"D x 19-3/4"H | 55 Quarts     | Chrome            |
| RSCTOHB-161319-ORB | 15-1/2"W x 13-1/2"D x 19-3/4"H | 55 Quarts     | Oil Rubbed Bronze |
| RSCTOHB-161319SN   | 15-1/2"W x 13-1/2"D x 19-3/4"H | 55 Quarts     | Satin Nickel      |
| RSCTOHB-211319CR   | 20-1/2"W x 13-1/2"D x 19-3/4"H | 74 Quarts     | Chrome            |
| RSCTOHB-211319-ORB | 20-1/2"W x 13-1/2"D x 19-3/4"H | 74 Quarts     | Oil Rubbed Bronze |
| RSCTOHB-211319SN   | 20-1/2"W x 13-1/2"D x 19-3/4"H | 74 Quarts     | Satin Nickel      |



**Removable Hamper Basket Bags, 15-1/2" & 20-1/2" Wide**



- Designed for RSCTOHB Series Tilt-Out Hampers
- Made of machine washable canvas
- Designed to fit tight and securely with hook and loop fasteners
- Strong handles for easy transport and removal
- 1.7 Bushels (55 qt.) for the 15-1/2"W unit (#RSCTOHB-161319 Series)
- 2.3 Bushels (74 qt.) for the 20-1/2"W unit (#RSCTOHB-211319 Series)

| Item#          | For Basket Size | For Item # Series | Color |
|----------------|-----------------|-------------------|-------|
| RSCTOHB-16-I-1 | 15-1/2"W        | RSCTOHB-161319    | Black |
| RSCTOHT-16-I-1 | 15-1/2"W        | RSCTOHB-161319    | Tan   |
| RSCTOHB-21-I-1 | 20-1/2"W        | RSCTOHB-211319    | Black |
| RSCTOHT-21-I-1 | 20-1/2"W        | RSCTOHB-211319    | Tan   |

A  
B  
C  
D  
E  
F  
G  
H  
I  
J  
K  
L  
M  
N  
O  
P  
Q  
R  
S  
T  
U  
V  
W  
X  
Y

A  
B  
C  
D  
E  
F  
G  
H  
I  
J  
K  
L  
M  
N  
O  
P  
Q  
R  
S  
T  
U  
V  
W  
X  
Y

## PULL-OUT HAMPER BASKETS



### Premium Hamper Basket Pull-Out w/Soft-Close

- Rev-A-Shelf CH Series
- Features bottom mount full-extension slides with Rev-A-Motion Soft-Open/Soft Close System
- Plastic carriage is available in silver or white
- Includes: (2) wire hamper baskets, (2) ivory canvas bags, door mount brackets, and installation screws
- Designed for a 24" wide opening
- Replacement canvas bag is sold separately, see below

| Item#              | Dimensions                   | Load Capacity | Finish/Color |
|--------------------|------------------------------|---------------|--------------|
| RSCH-241419-RM-211 | 24"W x 13-15/16"D x 18-7/8"H | 80 Quarts     | White/Ivory  |
| RSCH-241419-RM-217 | 24"W x 13-15/16"D x 18-7/8"H | 80 Quarts     | Silver/Ivory |
| RS5CHB-LINER       | Canvas Hamper Bag, Ivory     |               |              |



### Chrome Wire Hamper Basket Pull-Out w/Cloth Bag

- Rev-A-Shelf HRV Series
- Features full-extension slides
- Includes: (1) chrome wire basket, (1) cloth bag, and installation screws
- Replacement cloth bag and door mount kit are sold separately, see below

| Item#              | Dimensions                                   | Finish |
|--------------------|--|--------|
| RSHRV-1520-SCR     | 14-3/4"W x 18"D x 19-3/8"H                   | Chrome |
| <b>Accessories</b> |  |        |
| RSHRV-1520-LINER   | Replacement Ivory Cloth Bag                  |        |
| RSRV-DM17-KIT      | Silver Door Mount Kit For HRV Series Hampers |        |



### White Wire Hamper Basket Pull-Out

- Rev-A-Shelf HRV Series
- Features full-extension slides
- Includes: (1) white wire basket and installation screws
- Optional cloth bag (only for #RSHRV1520S) and door mount kit are sold separately, see below

| Item#              | Dimensions                                       | Finish |
|--------------------|--|--------|
| RSHRV1215S         | 11-7/8"W x 18"D x 14-3/4"H                       | White  |
| RSHRV1220S         | 11-7/8"W x 18"D x 19-3/8"H                       | White  |
| RSHRV1515S         | 14-3/4"W x 18"D x 14-3/4"H                       | White  |
| RSHRV1520S         | 14-3/4"W x 18"D x 19-3/8"H                       | White  |
| <b>Accessories</b> |  |        |
| RSHRV-1520-LINER   | Optional Ivory Cloth Bag (only fits #RSHRV1520S) |        |
| RSRVDM             | White Door Mount Kit For HRV Series Hampers      |        |



**PULL-OUT HAMPER BASKETS**



**Pull-Out Plastic Hamper Basket**



- Hamper pulls out smoothly on White epoxy coated, full extension, ball bearing slides
- Installs with 4 screws to the base of the cabinet (included)
- Basket is White
- Door mounting capabilities with the RSRVDM door mount kit

| Item#       | Dimensions                    | Load Capacity |
|-------------|-------------------------------|---------------|
| RSHPRV1520S | 14-1/4" W x 20" D x 19-1/4" H | 64 Qts.       |
| RSRVDM      | Door Mount Kit                |               |



**Pull-Out Plastic Tall Hamper With Lid, White**



- Features (1) tall hamper basket with 108 qt capacity and removable lid
- Full extension heavy duty ball bearing slides with 14" depth
- Easy installation with (4) screws attached to the base of the cabinet (included)
- Hamper is available with or without a door mount kit

| Item#                             | Dimensions                | Load Capacity |
|-----------------------------------|---------------------------|---------------|
| <b>Door Mount Hamper with Lid</b> |                           |               |
| RSHPRV1925DMS                     | 19-7/8" W x 14" D x 24" H | 108 Quarts    |
| <b>Pull-Out Hamper with Lid</b>   |                           |               |
| RSHPRV1925S                       | 19-7/8" W x 14" D x 24" H | 108 Quarts    |



**Pull-Out Hamper, Plastic Low Profile**



- Rolls out easily on White epoxy coated, full extension, ball bearing slides
- White, plastic basket has built in handles and lifts out of wire frame
- Includes: (1) polymer hamper/utility basket with frame, full extension slides and (4) screws
- Installs with 4 screws to the base of the cabinet
- Can be door mounted via optional door mount kit below

| Item#       | Dimensions                        | Load Capacity |
|-------------|-----------------------------------|---------------|
| RSHURV1512S | 14-3/8" W x 18-1/8" D x 11-7/8" H | 32 Quarts     |
| RSRVDM      | Door Mount Kit                    |               |

A  
B  
C  
D  
E  
F  
G  
H  
I  
J  
K  
L  
M  
N  
O  
P  
Q  
R  
S  
T  
U  
V  
W  
X  
Y

**A JEWELRY ORGANIZERS**

**Jewelry Drawer Organizer**

- One piece pre-assembled drawer box with full extension slides for 14" deep closets
- Two drawer box insert designs give the ability to store larger items like necklaces without tangling and the curved inside radius allows for full accessibility to small items such as earring backs
- Features full-extension ball bearing slides, and drawer front mounting capability using drawer mount brackets (described below)

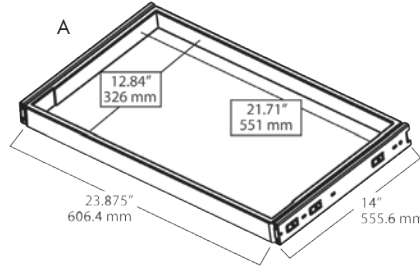

|                 | Item#         | Description                 | Dimensions               | Finish |
|-----------------|---------------|-----------------------------|--------------------------|--------|
| A               | RSCJD-2414    | Drawer Box w/Slides         | 24" W x 14" D x 1-7/8" H | Black  |
| B               | RSCJD-241IN   | Jewelry Insert              | 22" W x 13" D x 1-1/2" H | Velvet |
| C               | RSCJD-241S    | Necklace Insert             | 22" W x 13" D x 1-1/2" H | Velvet |
| <b>Brackets</b> |               |                             |                          |        |
|                 | RSCJD-DMB-KIT | Drawer Front Mount Brackets |                          |        |

**Undermount Jewelry Drawer**

- Soft-close undermount slides
- Wood construction
- Velvet bottom
- Easy installation, drawer front mountable
- Drawer accessories sold separately, see below

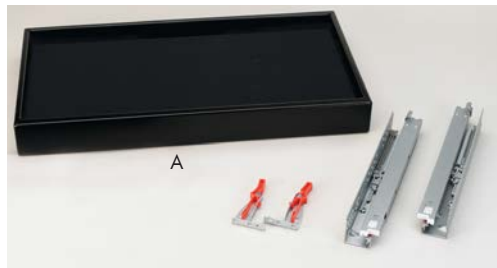

|  | Item #          | Dimensions         | Description               |
|--|-----------------|--------------------|---------------------------|
| <b>Soft-Close Jewelry Drawers</b>            |                 |                    |                           |
| A  | RSCVJD-1814UM-1 | 18"W x 14"D        | Soft-Close Jewelry Drawer |
|  | RSCVJD-2414UM-1 | 24"W x 14"D        |                           |
|  | RSCVJD-3014UM-1 | 30"W x 14"D        |                           |
| <b>Undermount Jewelry Drawer Accessories</b> |                 |                    |                           |
| B  | RSCV-RING-1     | 4-1/4"W x 11-5/8"D | Velvet Ring Organizer     |
| C  | RSCA-SMORG-1    | 4-1/4"W x 11-5/8"D | Bracelet Organizer        |
| D  | RSCA-LGORG-1    | 6"W x 11-5/8"D     | Earring Organizer         |
| E  | RSCA-NECKLACE-1 | 6"W x 11-5/8"D     | Necklace Organizer        |

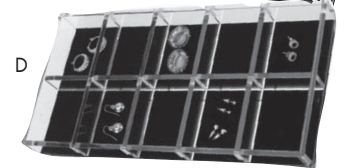
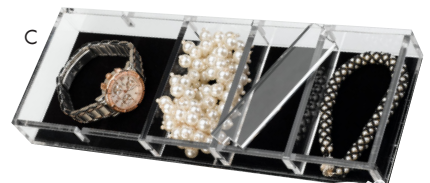

**PULL-OUT CLOSET MIRROR & WIRE SHOE RAIL**



**Soft-Close Pull-Out Mirror**



- Full extension soft-close and soft-open slide system
- Full length mirror 3-1/2"W x 14"D x 48"H
- Reversible mounting system, installs on right or left side panels
- Includes handle for easy opening
- Adjustable pivot - up to 60°
- Easy installation (only 8 screws and they are included)

| Item#           | Dimensions            | Finish            |
|-----------------|-----------------------|-------------------|
| RSCM-1448-SN-1  | 3-1/2"W x 14"D x 48"H | Satin Nickel      |
| RSCM-1448-ORB-1 | 3-1/2"W x 14"D x 48"H | Oil Rubbed Bronze |



**Acrylic Shelf Organizer, Shelf Dividers**



- Designed for 14" depth closet panels the organizers are 13-1/2" deep
  - Two heights of organizers available; 6-9/16" and 14-1/8" organizers are 1/4" thick
  - Organizers are provided with clear acrylic clips, clips are fastened to shelving via 5mm pins
- Packing: Single box includes 10 dividers and 40 clips.  
 Sold In: Full box quantities only.

| Item#     | Dimensions                         |
|-----------|------------------------------------|
| RSCPSD-6  | 13-1/2" D x 6-9/16" H x 1/4" Thick |
| RSCPSD-14 | 13-1/2" D x 14-1/8"H x 1/4" Thick  |

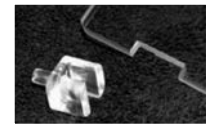

Clips are inserted into notches cut into the acrylic to hold dividers secure while inserting or removing shoes, boots or purses



**Wire Shoe Rail**



- Shoe rail is easy to install and features heavy gauge chrome railing
- Designed to fit 5mm bore mounting holes on 32mm spacing

| Dimensions      | Chrome Item#  | Oil Rubbed Bronze Item # | Satin Nickel Item # |
|-----------------|---------------|--------------------------|---------------------|
| 17" L x 2.25" H | RSCSR-17CR-5  | RSCSR-17ORB-10           | RSCSR-17SN-10       |
| 23" L x 2.25" H | RSCSR-23CR-5  | RSCSR-23ORB-10           | RSCSR-23SN-10       |
| 29" L x 2.25" H | RSCSR-29CR-10 | RSCSR-29ORB-10           | RSCSR-29SN-10       |
| 35" L x 2.25" H | RSCSR-35CR-5  | RSCSR-35ORB-10           | RSCSR-35SN-10       |

**A SLATWALL & ACCESSORIES**



Handi**SOLUTIONS**

**Slatwall Panels, Heavy Gauge PVC**

- Strong and durable, blended cellular PVC material
- Slats are 12-1/4" H x 4' L or 12-1/4" H x 8' L (includes 1/4" for tongue and groove assembly)
- Scratch and water resistant
- Compatible with most manufacturers standard slatwall accessories
- Color coordinated installation screws and trim available
- 39 boxes is equivalent to 1 skid (1 skid of 8' panels completes approximately 3 garages)

Packing: 4 panels per box. Full box quantities only.

| Panel Colors  | 4'-Panel Item # | 8'-Panel Item # |
|---------------|-----------------|-----------------|
| White         | GCHSW1004       | GCHSW1008       |
| Taupe         | GCHSW2004       | GCHSW2008       |
| Slate Gray    | GCHSW3004       | GCHSW3008       |
| Black         | GCHSW4004       | GCHSW4008       |
| Maple         | GCHSW5004       | GCHSW5008       |
| Oak           | GCHSW6004       | GCHSW6008       |
| Antique White | GCHSW8004       | GCHSW8008       |
| Graphite      | GCHSW13004      | GCHSW13008      |
| Beachwood     | GCHSW14004      | GCHSW14008      |
| Silver        | GCHSW15004      | GCHSW15008      |
| Driftwood     | GCHSW16004      | GCHSW16008      |



**Color Matched Drywall Screws**

- All screws have painted heads
- Drywall screws length: 1-5/8"
- Full box quantities only

Handi**SOLUTIONS**

| Screw Colors | Item #     | Box Qty |
|--------------|------------|---------|
| White        | GCHSWS100W | 1,000   |
| Taupe        | GCHSWS200T | 1,000   |
| Gray         | GCHSWS300G | 1,000   |
| Black        | GCHSWS400B | 1,000   |
| Maple        | GCHSWS500M | 1,000   |

| Screw Colors  | Item #       | Box Qty |
|---------------|--------------|---------|
| Oak           | GCHSWS600K   | 1,000   |
| Antique White | GCHSWS800AW  | 1,000   |
| Graphite      | GCHSWS1308G  | 1,000   |
| Beachwood     | GCHSWS1400BW | 1,000   |
| Silver        | GCHSWS1500S  | 1,000   |
| Driftwood     | GCHSWS1600S  | 1,000   |



A B C D

Handi**SOLUTIONS**

**Handi Solutions Baskets**

- Baskets have mounting hardware attached

|   | Item #     | Dimensions                   |   | Item #     | Dimensions                    |
|---|------------|------------------------------|---|------------|-------------------------------|
| A | GCHSB0312B | 3-1/4"H x 12-1/8"W x 3-5/8"D | C | GCHSB1218B | 7-5/8"H x 17-7/8"W x 12-3/4"D |
| B | GCHSB0812B | 7-3/4"H x 11-7/8"W x 8-1/2"D | D | GCHSB1224B | 4-3/4"H x 23-7/8"W x 12-3/8"D |

## SLATWALL ACCESSORIES



### Handi Solutions Shelves

- Shelves have mounting hardware attached

|   | Item #     | Dimensions                |
|---|------------|---------------------------|
| A | GCHSS1424B | 6"H x 24"W x 14-3/8"D     |
| B | GCHSS1324B | 9"H x 24-3/8"W x 12-3/4"D |
| C | GCHSS1448B | 6"H x 48"W x 14-3/8"D     |



### Handi Solutions Hose Storage

- Holds approximately 150' length of 5/8" diameter hose
- Enclosed storage for nozzles, etc.
- Requires two mounting clips for mounting



| Item#    | Description                   | Dimensions        |
|----------|-------------------------------|-------------------|
| GCHSHHLD | Wall Mount Hose Holder, Taupe | 13"H x 14"W x 6"D |



### Handi Solutions Tilt Storage Bins

- Multi-compartment tilt storage bins
- HandiSolutions™ accessories are compatible with most slat wall panel systems
- All storage bins require two accessory clips to fasten bins to slatwall



|   | Item#      | Compartments | Dimensions                   |
|---|------------|--------------|------------------------------|
| A | GCHSB09TOB | 9            | 2-5/8"D x 23-5/8"W x 3"H     |
| B | GCHSB06TOB | 6            | 3-5/8"D x 23-5/8"W x 4-3/8"H |
| C | GCHSB05TOB | 5            | 5-1/8"D x 23-5/8"W x 6-1/2"H |
| D | GCHSB04TOB | 4            | 6-7/8"D x 23-5/8"W x 8-1/8"H |

**A SLATWALL ACCESSORIES**

**Handi Solutions Hooks**

- All hooks fasten directly to slatwall
- Brand-new locking system on the hooks keeps the accessories in place
- Weight capacity on all hooks is 100 lbs.
- Simply push down on the lock to remove from the wall

**HandiSOLUTIONS®**

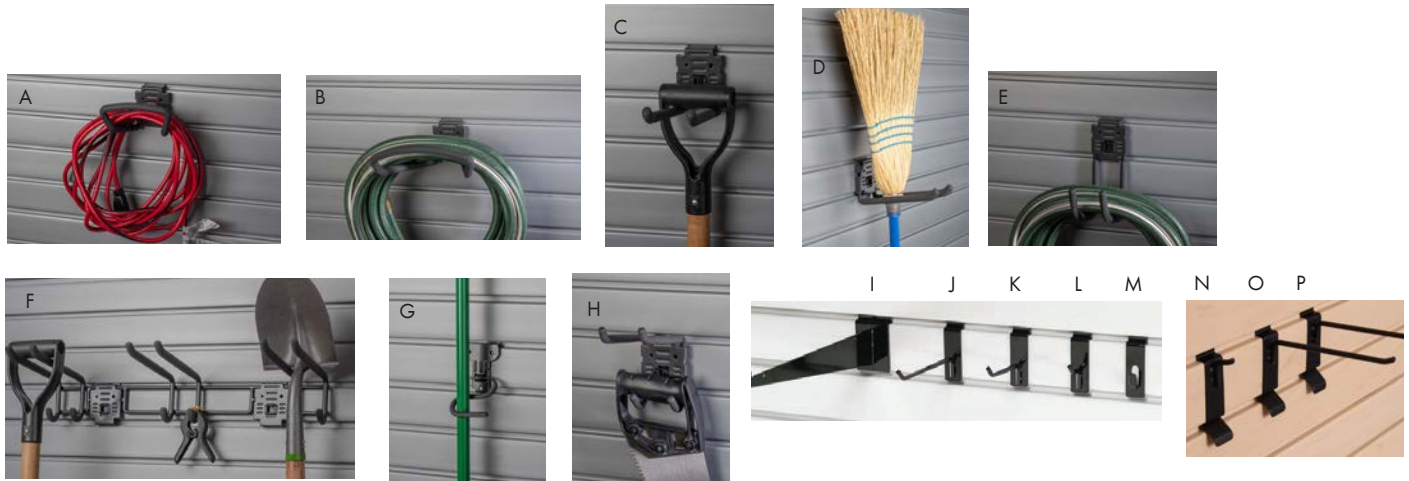

|   | Item#       | Description               |
|---|-------------|---------------------------|
| A | GCHSH04LBWL | 4" Wide Loop Hook         |
| B | GCHSH08LBWL | 8" Wide Loop Hook         |
| C | GCHSH04DBWL | 4" Projection Double Hook |
| D | GCHSH08DBWL | 8" Projection Double Hook |
| E | GCHSH06JBWL | 6" Projection J Hook      |
| F | GCHSH03SBWL | 24" Long Tool Bar         |
| G | GCHSSHKBNL  | S Hook                    |
| H | GCHSDUHBWL  | Double Utility Hook       |

|   | Item#      | (Projection Length)          |
|---|------------|------------------------------|
| I | GCHSS12SBB | 12" Projection Shelf Bracket |
| - | GCHSHS08B  | 8" Projection Single Hook    |
| J | GCHSHS06B  | 6" Projection Single Hook    |
| K | GCHSHS04B  | 4" Projection Single Hook    |
| L | GCHSHS01B  | 1" Projection Single Hook    |
| M | GCHSHNHB   | Notch Hook                   |
| N | GCHSH01SH  | 1" Projection Snap Hook      |
| - | GCHSH04SH  | 4" Projection Snap Hook      |
| O | GCHSH06SH  | 6" Projection Snap Hook      |
| P | GCHSH08SH  | 8" Projection Snap Hook      |

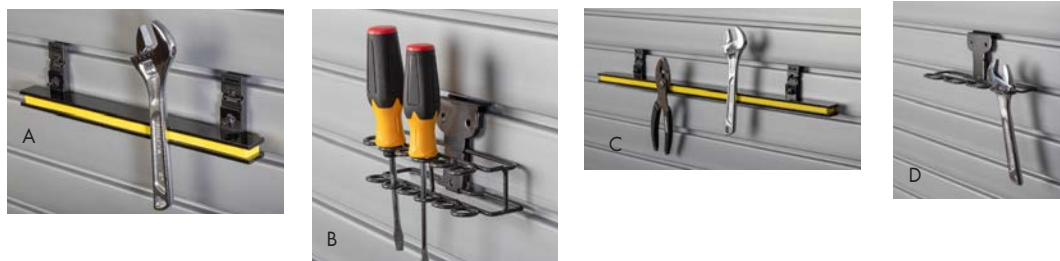

**HandiSOLUTIONS®**

**Handi Solutions Tool Holders**

- Regular tool holder is equipped with 1 attached bracket
- Magnetic tool holder is equipped with 2 attached brackets
- HandiSolutions™ accessories are compatible with most slat wall panel systems

|   | Item#      | Description           |
|---|------------|-----------------------|
| A | GCHSH13THB | 13" Magnetic Tool Bar |
|   | GCHSH24THB | 24" Magnetic Tool Bar |
| B | GCHSSDHB   | Screwdriver Rack      |
| C | GCHSSTRB   | Small Tool Rack       |

**SLATWALL ACCESSORIES & KITS**

**Handi Solutions Sport Racks**

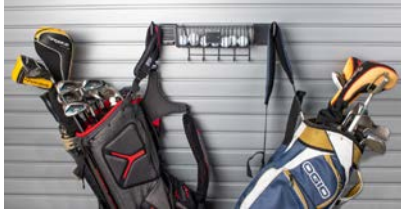

A



B



C

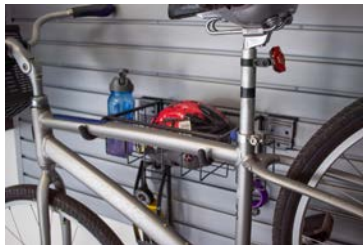

D



E



F

|   | Item#      | Description                                    | Dimensions                |
|---|------------|--|---------------------------|
| A | GCHSGAHB   | Golf Accessory Holder                          | 6"H x 19"W x 6"D          |
| B | GCHSH05B   | 5" Bike Hook (100 lb. weight capacity)         | 5"H x 3-1/2"W x 5-1/2"D   |
| C | GCHSFRH    | Fishing Rod Holder                             | 10-1/2"H x 3"W x 25-1/2"D |
| D | GCHSHBR    | Horizontal Bike Rack (100 lb. weight capacity) | 9"H x 20"W x 14-1/2"D     |
| E | GCHSSAR    | Sports Accessory Rack                          | 14"H x 2-1/2"W x 13"D     |
| F | GCHSS1324B | Shoe Rack                                      | 8"H x 24"W x 14"D         |



**Workbench Accessory Kit  
(Slatwall not included)**



Each 9 piece kit includes:

- (1) 9 Tilt Bin Storage (GCHSB09TOB pg. N-35)
- (1) 6 Tilt Bin Storage (GCHSB06TOB pg. N-35)
- (1) Paper Towel Holder
- (1) 13" Magnetic Tool Holder (GCHSH13THB pg. N-36)
- (1) Screwdriver Rack (GCHSSDHB pg. N-36)
- (1) 8" x 12" Basket (GCHSB0812B pg. N-34)
- (3) 4" Hook (GCHSHS04B pg. N-36)

Packing & Sold In: Each kit is pre-packaged in box.

| Item#   |
|---------|
| GCHSWBK |

A  
B  
C  
D  
E  
F  
G  
H  
I  
J  
K  
L  
M  
N  
O  
P  
Q  
R  
S  
T  
U  
V  
W  
X  
Y

A  
B  
C  
D  
E  
F  
G  
H  
I  
J  
K  
L  
M  
N  
O  
P  
Q  
R  
S  
T  
U  
V  
W  
X  
Y

## SLATWALL ACCESSORY KITS

### Handi Solutions Accessory Kits (Slatwall not included)

HandiSOLUTIONS®



#### Basic Accessory Kit

Each 21 piece kit includes:

- (1) 24" Tool Bar
- (2) 4" Double Hook (GCHSH04DBWL page N-44)
- (1) 8" Double Hook (GCHSH08DBWL page N-44)
- (1) 4" Loop Hook (GCHSH04LBWL page N-44)
- (1) 6" J Hook (GCHSH06JBWL page N-44)
- (1) 8" Loop Hook (GCHSH08LBWL page N-44)
- (1) 8" x 12" Basket (GCHSB0812B page N-42)
- (1) 12" x 24" Basket (GCHSB1224B page N-42)
- (3) Notch Hooks (GCHSHNHB page N-44)
- (3) 1" Hooks (GCHSHS01B page N-44)
- (6) 4" Hooks (GCHSHS04B page N-44)

Packing: Each kit is pre-packaged.

|              |
|--------------|
| <b>Item#</b> |
| GCHSBAKWL    |



#### Intermediate Accessory Kit

Each 33 piece kit includes:

- (1) 14" x 24" Shelf (GCHSS1424B page N-43)
- (1) 24" Tool Bar
- (4) 4" Double Hook (GCHSH04DBWL page N-44)
- (2) 8" Double Hook (GCHSH08DBWL page N-44)
- (1) 4" Loop Hook (GCHSH04LBWL page N-44)
- (1) 6" J Hook (GCHSH06JBWL page N-44)
- (2) 8" Loop Hook (GCHSH08LBWL page N-44)
- (1) 8" x 12" Basket (GCHSB0812B page N-42)
- (1) 12" x 24" Basket (GCHSB1224B page N-42)
- (1) 12" x 18" Basket (GCHSB1218B page N-42)
- (1) Shoe Rack (GCHSS1324B page N-43)
- (3) Notch Hook (GCHSHNHB page N-44)
- (3) 1" Hooks (GCHSHS01B page N-44)
- (6) 4" Hooks (GCHSHS04B page N-44)
- (3) 8" Hook (GCHSHS08B page N-44)

Packing: Each kit is pre-packaged in box.

|              |
|--------------|
| <b>Item#</b> |
| GCHSIKWL     |