

SECTION P - TABLE OF CONTENTS

Section P Contents:

Staples..... 2 - 3
 Brad Nails..... 4
 Finish Nails..... 5
 Micro Brads/Pins & Headless Pins..... 6
 Specialty Pneumatic Fasteners..... 7
 Fastener Overview..... 8
 Assembly Screws..... 9 - 15
 Face Frame/Pockethole Screws..... 16 - 19
 Installation and Trim Screws..... 20 - 22
 Drywall Screws..... 23
 Hinge, Slide & Hardware Screws.... 24 - 30
 Drawer Front Adjusting Screws..... 30
 Euro and Breadboard Screws..... 31
 Decorative Hardware Screws..... 32 - 33
 Screwdriver Bits & Accessories..... 34 - 36
 Tite Joint Fasteners (Dogbones)..... 36 - 37
 Covercaps and Finish Washers..... 38 - 41
 Mirror and Backsplash Clips..... 42
 Top and Desk Top Fasteners, Keyhole Fasteners..... 43
 Mending Plates & Corner Braces..... 44
 Keku Fasteners..... 45
 Post Hangers & Panel Retaining Clips..... 46
 Panel Hanging Clips (Z-Clips)..... 47
 Wall Anchors, T-Nuts & Biscuits..... 48 - 49
 Dowel Pins & Rods..... 50 - 51
 Striplox Connectors..... 52 - 56
 Confirmat & Connecting Screws..... 57
 Titus Fittings..... 58 - 60

LOOKING FOR A FASTENING SOLUTION?
We have you covered!

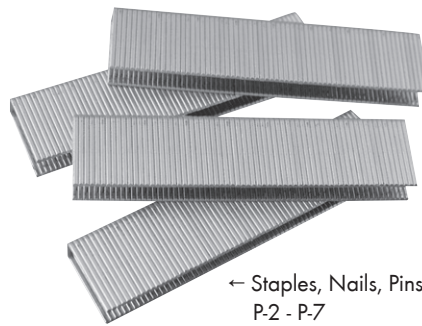

← Staples, Nails, Pins P-2 - P-7



↑ Assembly Screws, P-9 - P-15



↑ Face Frame/Pockethole Screws, P-16 - P-19



↑ Installation Screws, P-20 - P-22

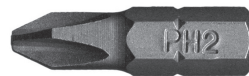

↑ Screwdriver Bits & Accessories, P-34 - P-36



↑ Hinge, Slide & Hardware Screws, P-24 - P-33



↑ Misc. Fasteners P-42 - P-49

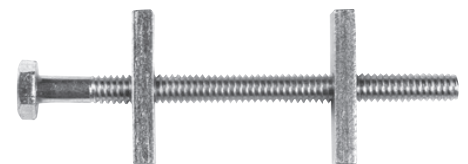

↑ Tite Joints/Dog Bones ↓ P-36 - P-37



↑ Striplox Connectors P-52 - P-56



↑ Dowel Pins/Rods, P-50 - P-51

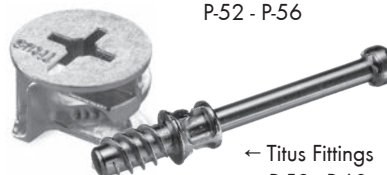

← Titus Fittings P-58 - P-60

A
B
C
D
E
F
G
H
I
J
K
L
M
N
O
P
Q
R
S
T
U
V
W
X
Y



A STAPLES

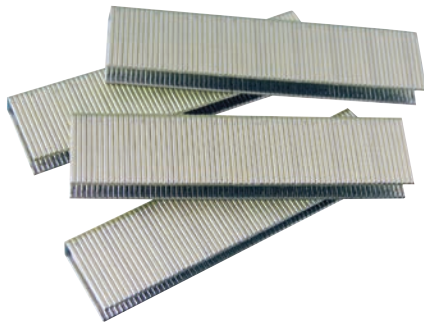

**Staples, 3/16" Crown
20 Gauge**



- Applications: Finish & Trim, Furniture & Bedding, Manufactured Housing, Millwork

Length	Item#	Box Qty
1/2"	WWFAESE-08-12	10,000

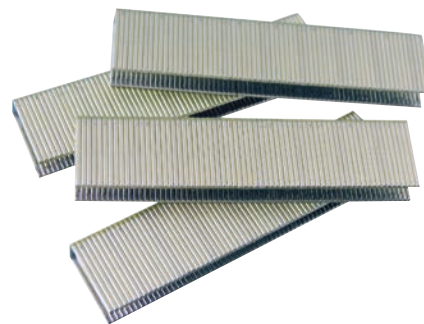

**Staples, 7/16" Medium Crown
16 Gauge**



- Applications: Furniture and case good face frames and side stiles, desk and cabinet box build up, soffit and fascia, casebacks, countertop build up, hardwood pallets, shipping crates and boxes, sash

Length	Item#	Box Qty
1-1/4"	WWS16125L	10,000
1-1/2"	WWS16150L	10,000
1-3/4"	WWS16175L	10,000
2"	WWS16200L	10,000

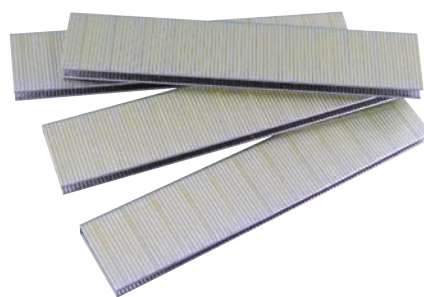

**Staples, 7/32" Crown
18 Gauge**



- Applications: Cabinet building, underlayment, moldings

Length	Item#	Box Qty
3/4"	WWS18075N	5,000
1"	WWS18100N	5,000
1-3/16"	WWS18119N	3,000
1-1/4"	WWS18125N	3,000

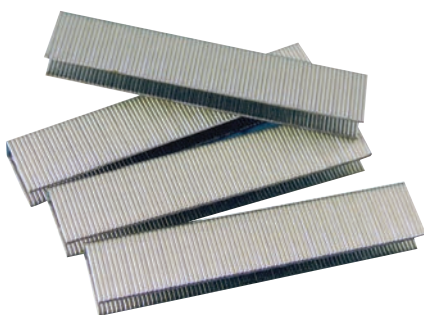

**Staples, 3/8" Crown
18 Gauge**



- Applications: Cabinetry and furniture, aluminum siding, mobile homes and RV's, and light metal to wood attachment

Length	Würth Item#	Box Qty	Senco Item#	Box Qty
5/8"	WWS18063M	5,000	SNM10BAB	5,000
3/4"	WWS18075M	5,000	SNM11BAB	5,000

STAPLES

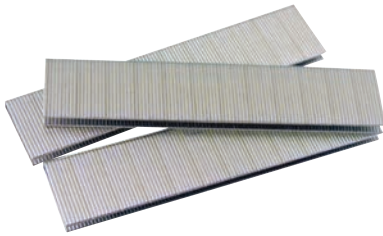

**Staples, 1/4" Narrow Crown
18 Gauge**

- Applications: Casebacks, pre-hung units, paneling, interior trim, drawers underlayment, door and window casings, cabinet assembly, lattice glue blocks, moldings and cabinet box assembly



Length	Würth Item#	Box Qty	Senco Item#	Box Qty	Porter Cable Item#	Box Qty
1/2"	WWS18050KT	5,000	SNL08BAB	10,000	RKNS18050	5,000
5/8"	WWS18063KT	5,000	SNL10BAB	5,000	RKNS18063	5,000
3/4"	WWS18075KT	5,000	SNL11BAB	5,000	RKNS18075	5,000
7/8"	WWS18088KT	5,000	SNL12BAB	5,000	RKNS18088	5,000
1"	WWS18100KT	5,000	SNL13BAB	5,000	RKNS18100	5,000
1-1/8"	WWS18113KT	5,000	SNL14BAB	5,000	-	-
1-1/4"	WWS18125KT	5,000	SNL15BAB	5,000	RKNS18125	5,000
1-1/2"	WWS18150KT	5,000	SNL17BAB	5,000	RKNS18150	5,000

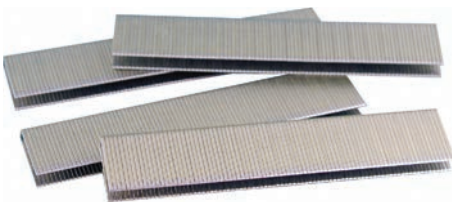

**Staples, 1/4" Crown
19 Gauge**

- Applications: Cabinets, casebacks, underlayment, molding and trim, lattice, and hardwood floors



Length	Würth Item#	Box Qty	Senco Item#	Box Qty
3/4"	WWS19075R	5,000	SNK11BAB-1	10,000

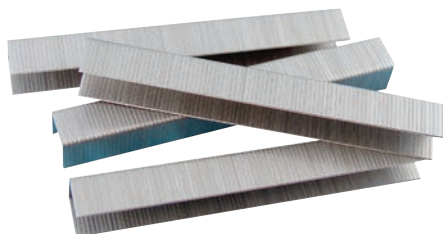

**Staples, 1/2" Crown
20 Gauge**

- Applications: Casebacks, molding, upholstery, and dust covers



Length	Würth Item#	Box Qty	Senco Item#	Box Qty
3/8"	WWS20038S	5,000	SNF06BAA	10,000
1/2"	-	-	SNF08BAA	10,000

LOOKING FOR A NEW STAPLE GUN?
See Section V

A
B
C
D
E
F
G
H
I
J
K
L
M
N
O
P
Q
R
S
T
U
V
W
X
Y

A
B
C
D
E
F
G
H
I
J
K
L
M
N
O
P
Q
R
S
T
U
V
W
X
Y

BRAD NAILS



Slight Head Brad Nails 18 Gauge

- Applications: Cabinets, furniture, woodworking, trim, dowels and joints, cabinet door frames and panels, drawer assembly, decorative wood, and plastic pieces



Length	Würth Item#	Box Qty	Senco Item#	Box Qty
5/8"	WWN18063B	5,000	SNAY10EAAP	5,000
3/4"	WWN18075B	5,000	SNAY11EAAP	5,000
1"	WWN18100B	5,000	SNAY13EAAP	5,000



Brad Nails 18 Gauge

- Applications: Carvings and ornamentals, furniture repair, cabinets and drawers, casebacks, small trim and baseboards



Length	Würth Item#	Box Qty	Senco Item#	Box Qty	Porter Cable Item#	Box Qty
5/8"	WWN18063A	5,000	-	-	RKBN18063	5,000
3/4"	WWN18075A	5,000	SNAX11EAAP	5,000	RKBN18075	5,000
1"	WWN18100A	5,000	SNAX13EAAP	5,000	RKBN18100	5,000
1-3/16"	WWN18119A	5,000	-	-	-	-
1-1/4"	WWN18125A	5,000	SNAX15EAAP	5,000	RKBN18125	5,000
1-1/2"	WWN18150A	5,000	SNAX17EAA	5,000	RKBN18150	5,000
1-9/16"	WWN18156A	5,000	-	-	-	-
1-5/8"	-	-	SNAX18EAA	5,000	-	-
1-3/4"	WWN18175A	5,000	-	-	-	-
2"	WWN18200A	5,000	-	-	RKBN18200	5,000

Mini Packs		
Length	Senco Item#	Box Qty
1"	SNA201009	1,000
1-1/4"	SNA201259	1,000
1-1/2"	SNA201509	800
2"	SNA202009	800

FINISH NAILS

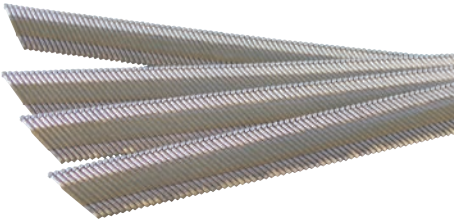

Angled Finish Nails 15 Gauge



- Applications: Vanities, molding and trim, dowels and joints, cabinet door frames, drawer assembly, picture frames, scribe moldings, furniture repair, carvings, ornamentals, blind pinning of upholstered and trim panels, and rattan

Length	Würth Item#	Box Qty	Senco Item#	Box Qty
1"	WWN15100E	4,000	-	-
1-1/4"	WWN15125E	4,000	SNDA15EPB	4,000
1-1/2"	WWN15150E	4,000	SNDA17EPB	4,000
1-3/4"	WWN15175E	4,000	SNDA19EPB	4,000
2"	WWN15200E	4,000	SNDA21EPB	4,000
2-1/4"	WWN15225E	4,000	SNDA23EPB	4,000
2-1/2"	WWN15250E	4,000	SNDA25EPB	3,000



Finish Nails 16 Gauge



- Applications: Cabinets, shelving, drawer boxes, trim and molding build-ups, and chair railings

Length	Item#	Box Qty
3/4"	WWN16075D	5,000
1"	WWN16100D	5,000
1-1/4"	WWN16125D	5,000
1-1/2"	WWN16150D	5,000
1-3/4"	WWN16175D	5,000
2"	WWN16200D	5,000
2-1/2"	WWN16250D	5,000

**LOOKING FOR A NEW
FINISH NAILER?**

See Section V



A MICRO BRADS/PINS



**Micro Brads
23 Gauge**



- Applications: Cabinet doors, light trim, carvings and ornamentals and picture frames

Length	Item#	Box Qty
7/8"	WWN23088B	10,000
1"	WWN23100B	10,000
1-3/16"	WWN23119B	10,000
1-3/8"	WWN23138B	10,000



**Micro Pins
23 Gauge**



- Applications: Cabinet doors, light trim, carvings and ornamentals and picture frames
- SNA109809 Assortment Pack contains 1/2" - 1" Micro Pins

Length	Würth Item #	Box Qty	Senco Item #	Box Qty	Senco Item #	Box Qty
1/2"	WWN23050F10	10,000	SNA100509	2,600	SNCZ08EAA	10,000
5/8"	WWN23058F10	10,000	SNA100629	2,600	SNCZ10EAA	10,000
3/4"	WWN23075F10	10,000	SNA100759	2,600	SNCZ11EAA	10,000
1"	WWN23100F10	10,000	SNA101009	2,600	SNCZ13EAA	10,000
1-1/4"	-	-	SNA101259	2,600	SNCZ15EAA	10,000
1-3/8"	-	-	SNA101379	2,600	SNCZ16EAA	10,000
1-1/2"	-	-	-	-	SNCZ17EAA	10,000
2"	-	-	-	-	SNCZ21EAA	10,000
Multi Pack: 1/2", 5/8", 3/4", 1"			SNA109809	2,500 Total	-	-



**Headless Pins
18 Gauge**



- Applications: Vanities, molding and trim, dowels and joints, cabinet door frames, drawer assembly, picture frames, scribe moldings, furniture repair, carvings, ornamentals, blind pinning of upholstered and trim panels, and rattan

Length	Item#	Box Qty
1/2"	WWFAEB812P	5,000
3/4"	WWN18075C	5,000
1"	WWN18100C	5,000

SPECIALTY PNEUMATIC FASTENERS



Corrugated Fasteners, 1" Crown 25 Gauge



- Applications: Butt Joints, cabinets, door and window sashes, millwork, pallets and pallet repair, crate and box assembly

Length	Item#	Box Qty
3/8"	SNX06NRA	5,000
1/2"	SNX08NRA	4,000



Senclamp 7/16" Crown 25 Gauge



- Applications: Butt Joints, cabinets, curios, mirror and picture frames

Length	Item#
5/16"	SNY05BFA
7/16"	SNY07BFA
9/16"	SNY09BFAN

WÜRTH BAER SUPPLY MOBILE APPLICATIONS

A convenient app designed to satisfy all of your needs by putting the power of our website into the palm of your hands!

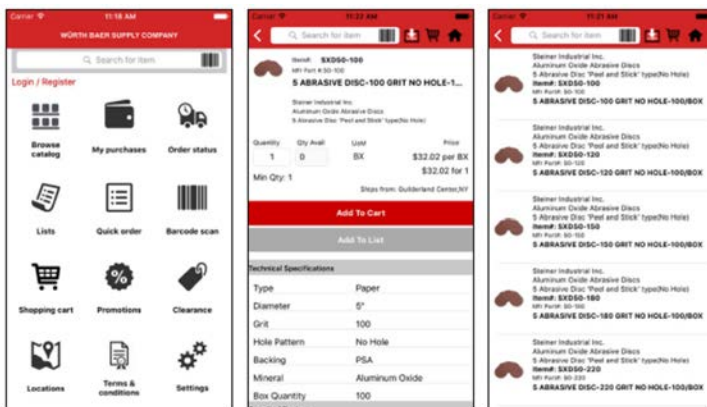

- Search for products or look up product details while away from your office – Saves you time!
- Don't remember a part number you bought in the past? – No worries, just go to the My Purchases screen. My Purchases is a running list of all products your company has purchased from Würth Baer Supply in the last 12 months.
- Have multiple jobs with different specifications? – Create a shared Shopping List for each job and make it easier for yourself and all your co-workers to order for the different jobs.
- No time to call customer service to place an order – Simply click, Add to cart and Submit.
- Running out of a product but still have a few in the box with a barcode on the side – Scan the barcode and add the product to the cart and you're all set to reorder.

It is simply that easy!

A FASTENER OVERVIEW

B
C
D
E
F
G
H
I
J
K
L
M
N
O
P
Q
R
S
T
U
V
W
X
Y

Head Guide

Flat	Flat with Nibs (Nibs make it easier to countersink)
Bugle	Pan
Modified Pan	Truss
Modified Truss	Trim
Round Washer	Undercut

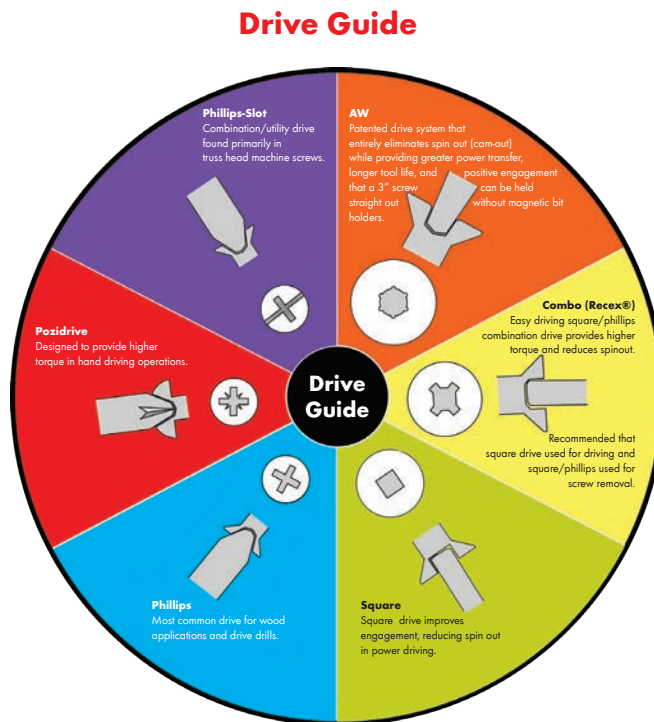

FIND IT FAST!

Checkout our **Screw & Fastener Quickfind** at:
www.wurthbaersupply.com

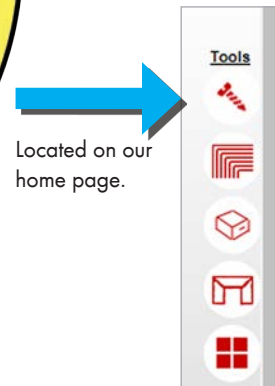

Located on our home page.

Thread and Point Guide

Fine Thread

General woodworking use, primarily with solid woods and hardwood. Requires pre-drilling and pre-countersinking.

Hi-Lo Thread

"All-purpose" thread. Designed for greater holding and less strip-out in all woods.

Coarse Thread

Used in particleboard and soft woods. Best results require pre-drilling and countersinking.

Turbo Thread

Virtually eliminates pre-drilling and countersinking. With features like nibs and a patented serrated tooth thread for less driving torque and reduced splitting. Recommended for real wood only - not for use in man made materials.

ASSY®

Patented "Asymmetrical / Symmetrical" thread geometry and 30° point locates screw precisely, drives fast, with 40% higher fracture torque than ordinary screws.

ASSY® Plus

Patented "ASSY" thread design plus a drill bit cutter head for clean, fast, non-splitting drive into all woods and near edges.

Type 17 Auger Point

Sharp slotted point acts as drill to eliminate pre-drilling for quicker, faster installation.

Double Auger

Fast, stress-free driving; minimizes pre-drilling in hardwoods.

Flat Screw Point

Machine screws. Used to attach decorative hardware and in RTA applications.

ASSEMBLY SCREWS

Flat Head Square Drive, Coarse Thread Without Nibs, Regular Point



- 3/4" and 1" lengths are threaded fully - all other sizes are threaded 2/3's from bottom of the screw
- Case hardened, Lubricated
- Uses #2 Square Drive bits
- Box quantities as shown on right
Sold in full boxes only

Length x Gauge	Finish	Box Qty	Item #	Bulk Qty	Item #
3/4" x 6	Lubricated	1,000	WW39215	15,000	WW39217
1" x 8	Lubricated	1,000	WW39230	10,000	WW39232
1-1/4" x 8	Lubricated	1,000	WW39235	7,500	WW39237
1-1/2" x 8	Lubricated	1,000	WW39240	5,000	WW39242
1-3/4" x 8	Lubricated	1,000	WW39250	4,000	WW39252
2" x 8	Lubricated	1,000	WW39255	3,500	WW39257
2-1/4" x 8	Lubricated	-	-	3,000	WW39262
2-1/2" x 8	Lubricated	1,000	WW39265	2,500	WW39267
3" x 8	Lubricated	1,000	-	1,500	WW39270

Flat Head Square Drive, Coarse Thread With Nibs, Type I7 Auger Point

- 1" are threaded fully - all other sizes are threaded 2/3's from bottom of the screw
- Case hardened finishes listed on right
- #2 Square Drive bits
- Box quantities as shown on right
Sold in full boxes only



Now available in a convenient bucket!

Size	Box		Bucket		Bulk	
	Item #	Box Qty	Item #	Box Qty	Item #	Box Qty
Black Oxidized Finish						
1" x 8	WW37100	1,000	WW37120-PAIL	7,000	WW37120	11,000
1-1/4" x 8	WW37140	1,000	WW37160-PAIL	5,000	WW37160	9,000
1-1/2" x 8	WW37180	1,000	WW37200-PAIL	5,000	WW37200	7,000
1-5/8" x 8	WW37220	1,000	WW37240-PAIL	3,500	WW37240	5,500
2" x 8	WW37280	1,000	WW37300-PAIL	3,000	WW37300	4,000
2-1/4" x 8	WW37305	1,000	WW37310-PAIL	2,500	WW37310	3,500
2-1/2" x 8	WW37340	1,000	WW37350-PAIL	2,500	WW37350	2,500
3" x 8	WW37380	1,000	WW37390-PAIL	2,000	WW37390	2,000
Zinc Finish						
1" x 8	WW31600	1,000	WW31700-PAIL	7,000	WW31700	11,000
1-1/4" x 8	WW31800	1,000	WW31900-PAIL	5,000	WW31900	9,000
1-1/2" x 8	WW38800	1,000	WW38900-PAIL	5,000	WW38900	7,000
1-5/8" x 8	WW39000	1,000	WW39100-PAIL	3,500	WW39100	5,500
2" x 8	WW39200	1,000	WW39300-PAIL	3,000	WW39300	4,000
2-1/4" x 8	WW39400	1,000	WW39500-PAIL	2,500	WW39500	3,500
2-1/2" x 8	WW39710	1,000	WW39715-PAIL	2,500	WW39715	2,500
3" x 8	WW39800	1,000	WW39900-PAIL	2,000	WW39900	2,000

A
B
C
D
E
F
G
H
I
J
K
L
M
N
O
P
Q
R
S
T
U
V
W
X
Y

A ASSEMBLY SCREWS

Flat Head Recex (Combo Phillips & Square) Drive, Coarse Thread With or Without Nibs, Regular Point



- 1" lengths are threaded fully - all other sizes are threaded 2/3's from bottom of the screw
- Case hardened, Lubricated
- Uses #2 Square Drive bits to insert; #2 Phillips Drive bits can be used for aftermarket adjustment
- Box quantities as shown below. Sold in full boxes only.



Without Nibs, With Regular Point



With Nibs, With Regular Point

Length x Gauge	Finish	Box Qty	Item #	Bulk Qty	Item #
Without Nibs, Regular Point					
1" x 8	Lubricated	1,000	WW38820	10,000	WW38822
1-1/4" x 8	Lubricated	1,000	WW38825	7,500	WW38827
1-1/2" x 8	Lubricated	1,000	WW38830	5,000	WW38832
1-3/4" x 8	Lubricated	-	-	4,000	WW38837
2" x 8	Lubricated	1,000	WW38842	3,500	WW38840
2-1/2" x 8	Lubricated	-	-	2,500	WW38852
3" x 8	Lubricated	-	-	1,500	WW38870
With Nibs, Regular Point					
1-1/4" x 8	Lubricated	1,000	WW39020	7,500	WW39022
1-1/2" x 8	Lubricated	1,000	WW39025	5,000	WW39027
1-3/4" x 8	Lubricated	1,000	WW39030	4,000	WW39032
2" x 8	Lubricated	-	-	3,500	WW39037
2-1/2" x 8	Lubricated	-	-	2,500	WW39055
3" x 8	Lubricated	-	-	1,500	WW39075

FIND IT FAST!

Check out our **Screw & Fastener Quickfind** at: www.wurthbaersupply.com

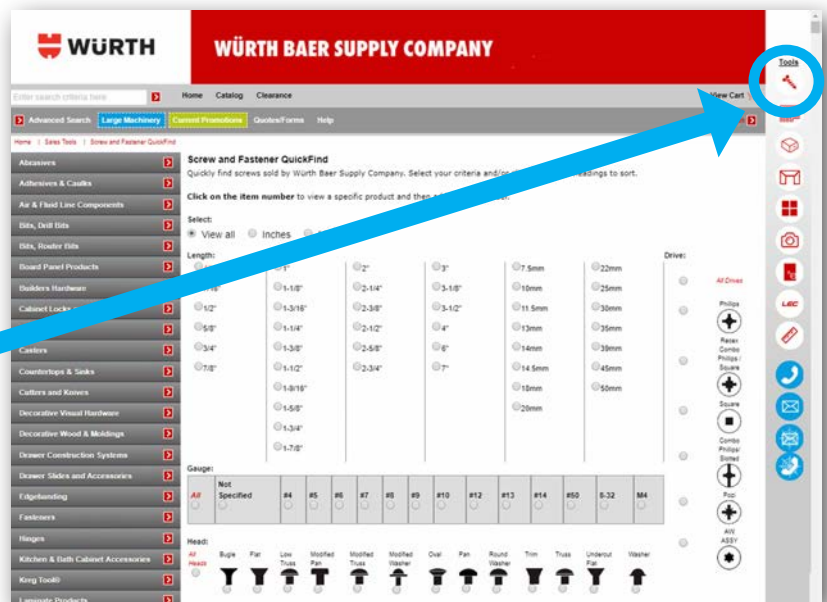

ASSEMBLY SCREWS



Flat Head Recex (Combo Phillips & Square) Drive, Coarse Thread With Nibs and Type 17 Auger Point



- 1" lengths are threaded fully - all other sizes are threaded 2/3's from bottom of the screw
- Case hardened, finishes listed below
- Uses #2 Square Drive bits to insert; #2 Phillips Drive bits can be used for aftermarket adjustment
- Box quantities as shown below. Sold in full boxes only.

Length x Gauge	Finish	Box Qty	Item #	Bulk Qty	Item #
1" x 8	Black	1,000	WW36710	11,000	WW36715
1-1/4" x 8	Black	1,000	WW36720	9,000	WW36725
1-1/2" x 8	Black	1,000	WW36730	7,000	WW36735
1-3/4" x 8	Black	1,000	WW36750	4,800	WW36755
2" x 8	Black	1,000	WW36760	4,000	WW36765
2-1/4" x 8	Black	1,000	WW36770	3,500	WW36775
2-1/2" x 8	Black	1,000	WW36780	2,500	WW36785
3" x 8	Black	1,000	WW36790	2,000	WW36793
1" x 8	Zinc	1,000	WW36820	-	-
1-1/4" x 8	Zinc	1,000	WW36822	9,000	WW36830
1-1/2" x 8	Zinc	1,000	WW36835	7,000	WW36840
1-5/8" x 8	Zinc	1,000	WW36845	5,500	WW36850
2" x 8	Zinc	1,000	WW36870	4,000	WW36875
2-1/4" x 8	Zinc	-	-	3,500	WW36885
2-1/2" x 8	Zinc	1,000	WW36890	2,500	WW36895
3" x 8	Zinc	-	-	2,000	WW36910



Flat Head Recex (Combo Phillips & Square) Drive, Coarse Thread With Nibs and Double Auger Point



- Double Auger for faster, stress-free driving; minimizes pre-drilling in hardwoods
- Case hardened, Lubricated
- Uses #2 Square Drive bits to insert; #2 Phillips Drive bits can be used for aftermarket adjustment
- Box quantities as shown below. Sold in full boxes only.

Length x Gauge	Finish	Box Qty	Item #	Bulk Qty	Item #
1-1/4" x 8	Lubricated	1,000	WL5B81250P	9,000	WL5B81250B
1-1/2" x 8	Lubricated	1,000	WL5B81500P	7,000	WL5B81500B
1-5/8" x 8	Lubricated	1,000	WL5B81750P	5,000	WL5B81750B
2" x 8	Lubricated	1,000	WL5B82000P	4,000	WL5B82000B
2-1/2" x 8	Lubricated	500	WL5B82500P	2,500	WL5B82500B
3" x 8	Lubricated	-	-	2,000	WL5B83000B

A

ASSEMBLY SCREWS

B

C

D

E

F

G

H

I

J

K

L

M

N

O

P

Q

R

S

T

U

V

W

X

Y



Serrated thread for quick start and reduced splitting.

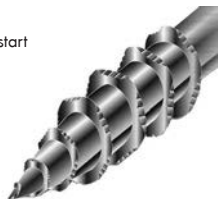

Flat Head Recex (Combo Phillips & Square) Drive, Turbo Thread With Nibs, Regular Point

- Patented serrated tooth turbo thread allows for quick starting, reduced splitting and less drive torque
- Use in all wood working applications: assembly, face frame, slides, hinges and hardware
- 3/4" and 1" lengths are threaded fully - all other sizes are threaded 2/3' s from bottom of the screw
- Case hardened, Lubricated
- Uses #2 Square Drive bits to insert; #2 Phillips Drive bits used for aftermarket adjustment
- Box quantities as shown below. Sold in full boxes only.

Length x Gauge	Finish	Box Qty	Item #	Bulk Qty	Item #
3/4" x 8	Lubricated	-	-	15,000	WW31950
1" x 8	Lubricated	1,000	WW32000	10,000	WW32100
1-1/8" x 8	Lubricated	1,000	WW32200	8,000	WW32300
1-1/4" x 8	Lubricated	1,000	WW32400	7,500	WW32500
1-1/2" x 8	Lubricated	1,000	WW32800	5,000	WW32900
1-3/4" x 8	Lubricated	1,000	WW33000	4,000	WW33100
2" x 8	Lubricated	1,000	WW33200	3,500	WW33300
2-1/2" x 8	Lubricated	1,000	WW33600	2,500	WW33700
2-3/4" x 8	Lubricated	1,000	WW33800	2,000	WW33900
3" x 8	Lubricated	1,000	WW34000	1,500	WW34100

Flat Head Phillips Drive Screws, Coarse Thread Without Nibs, Regular Point

- 3/4" and 1" lengths are threaded fully - all other sizes are threaded 2/3' s from bottom of the screw
- Case hardened, finishes listed below
- Uses #2 Phillips Drive bits
- Box quantities as shown below. Sold in full boxes only.



Length x Gauge	Finish	Box Qty	Item #	Bulk Qty	Item #
3/4" x 6	Lubricated	1,000	WW38720	15,000	WW38710
1" x 8	Lubricated	1,000	WW38730	10,000	WW38732
1-1/4" x 8	Lubricated	-	-	7,500	WW38738
1-1/2" x 8	Lubricated	-	-	5,000	WW38742
2" x 8	Lubricated	1,000	WW38750	-	-
4" x 10	Lubricated	-	-	1,000	WW37400
3/4" x 6	Black	1,000	WW38330	-	-
1-1/4" x 8	Black	1,000	WW38350	-	-
1-1/2" x 8	Black	1,000	WW38360	-	-
1-5/8" x 8	Black	-	-	5,500	WW38375
1-3/4" x 8	Black	-	-	4,800	WW38385
2" x 8	Black	-	-	4,000	WW38395
2-1/2" x 8	Black	-	-	2,500	WW38415
3" x 8	Black	1,000	WW38425	-	-

ASSEMBLY SCREWS



**Flat Head Phillips Drive, Coarse Thread
With Nibs, Type 17 Auger Point**



- 1" lengths are threaded fully - all other sizes are threaded 2/3's from bottom of the screw
 - Case hardened, finishes listed below
 - Uses #2 Phillips Drive bits
 - Box quantities as shown below.
- Sold in full boxes only.

**Now available in
a convenient bucket!**

Size	Box		Bucket		Bulk	
	Item #	Box Qty	Item #	Box Qty	Item #	Box Qty
Black Oxidized Finish						
1" x 8	WW34200	1,000	WW34220-PAIL	7,000	WW34220	11,000
1-1/4" x 8	WW34240	1,000	WW34260-PAIL	5,000	WW34260	9,000
1-1/2" x 8	WW34280	1,000	WW34300-PAIL	5,000	WW34300	7,000
1-5/8" x 8	WW34320	1,000	WW34340-PAIL	3,500	WW34340	5,500
1-3/4" x 8	WW34350	1,000	-	-	WW34360	4,800
2" x 8	WW34400	1,000	WW34420-PAIL	3,000	WW34420	4,000
2-1/4" x 8	WW34440	1,000	WW34460-PAIL	2,500	WW34460	3,500
2-1/2" x 8	WW34480	1,000	WW34500-PAIL	2,500	WW34500	2,500
3" x 8	-	-	WW34580-PAIL	2,000	WW34580	2,000
Zinc Finish						
1" x 8	WW30000	1,000	WW30100-PAIL	7,000	WW30100	11,000
1-1/4" x 8	WW30200	1,000	WW30300-PAIL	5,000	WW30300	9,000
1-1/2" x 8	WW30400	1,000	WW30500-PAIL	5,000	WW30500	7,000
1-5/8" x 8	WW30600	1,000	WW30700-PAIL	3,500	WW30700	5,500
1-3/4" x 8	WW30795	1,000	-	-	WW30798	4,800
2" x 8	WW30800	1,000	WW30900-PAIL	3,000	WW30900	4,000
2-1/4" x 8	-	-	WW31100-PAIL	2,500	WW31100	3,500
2-1/2" x 8	WW31200	1,000	WW31300-PAIL	2,500	WW31300	2,500
3" x 8	WW31400	1,000	WW31500-PAIL	2,000	WW31500	2,000

A
B
C
D
E
F
G
H
I
J
K
L
M
N
O
P
Q
R
S
T
U
V
W
X
Y

A ASSEMBLY SCREWS



**Flat Head Phillips Drive
Twinfast Thread, Without Nibs,
With Sharp Point, Black Finish**



- Twinfast screws drive 66% faster than a standard wood screw; double lead threads drive into the hardest woods
- Case hardened, Black
- Uses #2 Phillips bits
- Box quantities as shown below. Sold in full boxes only.

Length x Gauge	Finish	Box Qty	Item #	Bulk Qty	Item #
1-1/4" x 8	Black	1,000	WW30915	9,000	WW30920
1-1/2" x 8	Black	1,000	WW30925	7,000	WW30930
2" x 8	Black	1,000	WW30955	3,500	WW30960



ASSY: Without Nibs, With Sharp 30° Point

**Flat Head AW® Drive, ASSY Thread
With or Without Nibs, Sharp 30° Point
or Drill Point**



Ecofast ASSY: With Nibs, With Sharp 30° Point

- Patented high tech ASSY thread design provides faster driving and 40% stronger hold
- Patented AW drive system delivers superior torque while virtually eliminating cam-out
- All screw boxes are packaged with one AW insert drive bit
- Thin, lubricated shank reduces wood splitting
- Case hardened, Zinc
- Box quantities as shown below. Sold in full boxes only.

**Bit included
in each box!**



ASSY Plus: With Nibs, With Type 2 Drill Point

Length x Gauge	Finish	Box Qty	ASSY No Nibs, Sharp 30° Point	Ecofast ASSY w/Nibs Sharp 30° Point	ASSY Plus w/Nibs Type 2 Drill Point
5/8" x 6	Zinc	1,000	WW17043516	-	-
3/4" x 6	Zinc	1,000	WW17043520	-	-
1" x 8	Zinc	1,000	-	WW17014025	WW165914025
1-3/16" x 8	Zinc	500	-	WW17014030	WW16510430
1-3/8" x 8	Zinc	500	-	WW17014035	WW16510435
1-9/16" x 8	Zinc	500	-	WW17014040	WW16511440
1-3/4" x 8	Zinc	500	-	WW17014045	WW16511445
2" x 8	Zinc	500	-	WW17014050	WW16510450
2-3/8" x 8	Zinc	250	-	WW17014060	WW16510460
2-3/4" x 8	Zinc	250	-	WW17014070	WW16510470
3-1/8" x 9	Zinc	200	-	-	WW165104580

ASSEMBLY SCREWS



Serrated thread for quick start and reduced splitting.

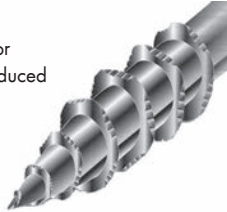

Washer Head Recex (Combo Phillips & Square) Drive Turbo Thread, Regular Point



- Round Washerhead typically used in soft woods to prevent head from sinking into wood
- Patented serrated tooth turbo thread allows for quick starting, reduced splitting, and less drive torque. Used in all woodworking applications: assembly, face frame, slides, hinges and hardware
- 1" lengths are threaded fully - all other sizes are threaded 2/3's from bottom of the screw
- Case hardened, Lubricated
- Uses #2 Square Drive bits to insert; #2 Phillips Drive bits can be used for aftermarket adjustment
- Box quantities as shown below. Sold in full boxes only.

Length x Gauge	Finish	Box Qty	Item #	Bulk Qty	Item #
1" x 8	Lubricated	1,000	WW34600	8,000	WW34700
1-1/8" x 8	Lubricated	1,000	WW34800	6,000	WW34900
1-1/4" x 8	Lubricated	1,000	WW35000	6,500	WW35100
1-3/8" x 8	Lubricated	1,000	WW35200	5,000	WW35300
1-1/2" x 8	Lubricated	1,000	WW35400	5,000	WW35500
1-3/4" x 8	Lubricated	1,000	WW35600	4,000	WW35700
2" x 8	Lubricated	1,000	WW35800	3,000	WW35900
2-1/4" x 8	Lubricated	1,000	WW36000	2,000	WW36100
2-1/2" x 8	Lubricated	1,000	WW36200	2,000	WW36300
2-3/4" x 8	Lubricated	-	-	1,500	WW36500
3" x 8	Lubricated	1,000	WW36600	1,500	WW36700

FIND IT FAST!

Check out our

Screw & Fastener Quickfind at:

www.wurthbaersupply.com

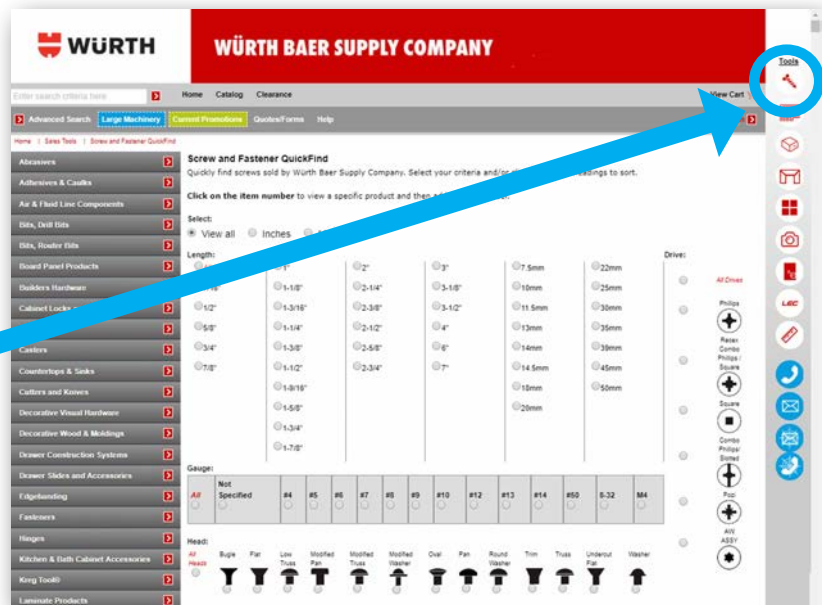

A
B
C
D
E
F
G
H
I
J
K
L
M
N
O
P
Q
R
S
T
U
V
W
X
Y

A FACE FRAME/POCKETHOLE SCREWS

B
C
D
E
F
G
H
I
J
K
L
M
N
O
P
Q
R
S
T
U
V
W
X
Y



Modified Pan Head, Square Drive Fine Thread, Type 17 Auger Point



- For hardwoods such as Oak and Maple
- Case hardened, Black
- Uses #2 Square Drive bits
- Box quantities as shown below. Sold in full boxes only.

Length x Gauge	Finish	Box Qty	Item #	Bulk Qty	Item #
1-1/4" x 6	Black	1,000	WL3B61250P	8,000	WL3B61250B
1-1/2" x 6	Black	1,000	WL3B61500P	7,000	WL3B61500B
1-1/4" x 7	Black	1,000	WW16000	7,500	WW16100
1-1/2" x 7	Black	1,000	WW16200	6,000	WW16300



Modified Pan Head, Square Drive Fine Thread Double Auger Point



- Minimizes pre-drilling in even the hardest woods
- Case hardened, Lubricated
- Uses #2 Square Drive bits
- Box quantities as shown below. Sold in full boxes only.

Length x Gauge	Std Box Qty	Item #	Bulk Box Qty	Item #
1-1/4" x 6	1,000	WL3D61250P	8,000	WL3D61250B
1-1/2" x 6	1,000	WL3D61500P	7,000	WL3D61500B



Modified Pan Head, Square Drive Hi-Lo Thread, Type 17 Auger Point



- All purpose screw with Hi-Lo thread for greater holding power and less strip out in hardwoods, medium woods, and soft woods
- Case hardened, Lubricated
- Uses #2 Square Drive bits
- Box quantities as shown below. Sold in full boxes only.

Length x Gauge	Finish	Box Qty	Item #	Bulk Qty	Item #
1-1/4" x 7	Lubricated	1,000	WW15000	7,500	WW15100
1-1/2" x 7	Lubricated	1,000	WW15200	6,000	WW15300

FACE FRAME/POCKETHOLE SCREWS



Modified Pan Head, Square Drive Coarse Thread Extra Long Type 17 Auger Point

- Features an extra long aggressive cutting point that cuts through the toughest materials
- Elongated cutting flute reduces splitting and cracking
- Case hardened, Lubricated
- Uses #2 Square Drive bits
- Box quantities as shown below. Sold in full boxes only.

Length x Gauge	Finish	Box Qty	Item #	Bulk Qty	Item #
1-1/4" x 7	Lubricated	1,000	WW17000	7,500	WW17100
1-1/2" x 7	Lubricated	1,000	WW17200	6,000	WW17300



Pan Head Square or Phillips Drive, Fine Thread Type 17 Auger Point

- Standard fine thread for hardwoods such as Oak and Maple
- Case hardened, Black
- Uses #2 Square or Phillips Drive bits
- Box quantities as shown below. Sold in full boxes only.

Length x Gauge	Finish	Box Qty	Item #	Bulk Qty	Item #
Square Drive					
1-1/4" x 6	Black	1,000	WW12500	10,000	WW12520
1-1/2" x 6	Black	1,000	WW12800	8,500	WW12820
Phillips Drive					
1-1/4" x 6	Black	1,000	WW10200	10,000	WW18000



Pan Head Square or Phillips Drive, Coarse Thread Type 17 Auger Point

- Excellent holding in soft woods, MDF and particleboard
- Case hardened, finishes listed below
- Uses #2 Square or Phillips Drive bits
- Box quantities as shown below. Sold in full boxes only.

Length x Gauge	Finish	Box Qty	Item #	Bulk Qty	Item #
Square Drive					
1-1/4" x 7	Black	1,000	WW12000	7,500	WW12100
1-1/2" x 7	Black	1,000	WW12200	6,000	WW12300
Phillips Drive					
1-1/4" x 6	Lubricated	1,000	WW10000	10,000	WW10100

A
B
C
D
E
F
G
H
I
J
K
L
M
N
O
P
Q
R
S
T
U
V
W
X
Y

A
B
C
D
E
F
G
H
I
J
K
L
M
N
O
P
Q
R
S
T
U
V
W
X
Y

FACE FRAME/POCKETHOLE SCREWS



Square Drive



Combo Phillips/Square Drive

Round Washer Head Square or Recex (Combo Phillips & Square) Drive, Coarse Thread, Type 17 Auger Point



- Excellent holding in soft woods, MDF, and particleboard
- Round washer head prevents crushing into the bottom of the face frame hole
- Case hardened, finishes listed below
- Uses #2 Square Drive bits
- Box quantities as shown below. Sold in full boxes only.

Length x Gauge	Finish	Box Qty	Item #	Bulk Qty	Item #
Square Drive					
1-1/4" x 8	Lubricated	1,000	WL3F81250P	8,000	WL3F81250B
1-1/2" x 8	Lubricated	1,000	WL3F81500P	7,000	WL3F81500B
Combo Phillips & Square Drive					
1-1/4" x 8	Black	1,000	WW18500	7,000	WW18520
1-1/2" x 8	Black	1,000	WW18600	5,000	WW18620



Round Washer Head Square Drive Fine Thread Type 17 Auger Point



- Standard fine thread for hardwoods such as Oak and Maple
- Prevents the head from crushing into the bottom of the face frame hole
- Case hardened, Black
- Uses #2 Square Drive bits
- Box quantities as shown below. Sold in full boxes only.

Length x Gauge	Finish	Box Qty	Item #	Bulk Qty	Item #
1-1/4" x 7	Black	1,000	WW18705	8,000	WW18700



Round Washer Square Drive, Fine Thread Type 17 Auger Point



- Standard fine thread for hardwoods such as oak, maple, walnut, cherry, hickory, etc.
- Large washer head provides a superior hold in the bottom of the pocket and prevents the screw from being overdriven
- Case Hardened, Zinc
- Uses #2 Square Drive Bits
- Box quantities as shown below. Sold in full boxes only.

For Kreg Jigs, Accessories, see Section U
For Kreg Machinery, see Section W

1-1/4" L x 7 Gauge		1-1/2" L x 7 Gauge	
Item #	Box Qty	Item #	Box Qty
KJSMLF125-100	100	KJSMLF150-100	100
KJSMLF125-500	500	KJSMLF150-500	500
KJSMLF125-1200	1,200	KJSMLF150-1200	1,200
KJSMLF125-5000	5,000	-	-

FACE FRAME/POCKETHOLE SCREWS



For Kreg Jigs, Accessories, see Section U
For Kreg Machinery, see Section W

Round Washer Square Drive, Coarse Thread Type 17 Auger Point



- Coarse thread for soft woods and composites, Plywood, MDF, Pine, etc.
- Large washer head provides a superior hold in the bottom of the pocket and prevents the screw from being overdriven
- Case Hardened, Zinc finish
- Uses #2 Square Drive Bits
- Box quantities as shown below.
Sold in full boxes only.

1" L x 8 Gauge		1-1/4" L x 8 Gauge		1-1/2" L x 8 Gauge		2" L x 8 Gauge		2-1/2" L x 8 Gauge	
Item #	Box Qty	Item #	Box Qty	Item #	Box Qty	Item #	Box Qty	Item #	Box Qty
KJSML-C1-100	100	KJSML-C125-100	100	KJSML-C150-100	100	KJSML-C2-50	50	KJSML-C250-50	50
-	-	KJSML-C125-250	250	-	-	-	-	KJSML-C250-125	125
KJSML-C1-500	500	KJSML-C125-500	500	KJSML-C150-500	500	KJSML-C2-250	250	KJSML-C250-250	250
KJSML-C1-1200	1,200	KJSML-C125-1200	1,200	KJSML-C150-1200	1,200	KJSML-C2-3000	3,000	KJSML-C250-2000	2,000
-	-	KJSML-C125-5000	5,000	-	-	-	-	-	-



For Kreg Jigs, Accessories, see Section U
For Kreg Machinery, see Section W

Modified Pan Square Drive, Coarse Thread Type 17 Auger Point



- Case Hardened, Zinc finish
- Uses #2 Square Drive Bits
- Box quantities as shown below. Sold in full boxes only.

1" L x 6 Gauge			
Item #	Box Qty	Item #	Box Qty
KJSPS-C1-100	100	KJSPS-C1-500	500
KJSPS-C1-250	250	KJSPS-C1-1200	1,200



For Kreg Jigs, Accessories, see Section U
For Kreg Machinery, see Section W

Modified Pan Square Drive, Fine Thread Type 17 Auger Point



- Standard fine thread for hardwoods such as oak, maple, walnut, cherry, hickory, etc.
- Case Hardened, Zinc finish
- Uses #2 Square Drive Bits
- Box quantities as shown below. Sold in full boxes only.

3/4" L x 6 Gauge		1" L x 6 Gauge		1-1/4" L x 6 Gauge		1-1/2" L x 6 Gauge	
Item #	Box Qty	Item #	Box Qty	Item #	Box Qty	Item #	Box Qty
KJSPS-F075-100	100	KJSPS-F1-100	100	KJSPS-F125-100	100	KJSPS-F150-100	100
KJSPS-F075-500	500	KJSPS-F1-500	500	KJSPS-F125-500	500	KJSPS-F150-500	500
KJSPS-F075-1200	1,200	KJSPS-F1-1200	1,200	KJSPS-F125-1200	1,200	KJSPS-F150-1200	1,200

A
B
C
D
E
F
G
H
I
J
K
L
M
N
O
P
Q
R
S
T
U
V
W
X
Y

A
B
C
D
E
F
G
H
I
J
K
L
M
N
O
P
Q
R
S
T
U
V
W
X
Y

INSTALLATION SCREWS



Washer Head Recex (Combo Phillips & Square) Drive, Quickcutter Thread Type 17 Auger Point



- Case hardened, Zinc
- Uses #2 Square Drive bits to insert & #2 Phillips Drive bits for aftermarket adjustment
- Box quantities as shown below. Sold in full boxes only.

Length x Gauge	Box Qty	Item #	Bulk Qty	Item #
Zinc With Zinc Head				
2-1/2" x 10	500	WL7D102500ZP	1,500	WL7D102500ZB
3" x 10	500	WL7D103000ZP	1,500	WL7D103000ZB
3-1/2" x 10	-	-	1,000	WL7D103500ZB
Zinc With White Head				
2-1/2" x 10	-	-	1,500	WL7D102500WB
3" x 10	500	WL7D103000WP	1,500	WL7D103000WB



Washer Head Recex (Combo Phillips & Square Drive), Coarse Thread Regular Point



- Case hardened, finishes listed below
- Uses #2 Square drive bit to insert & #2 Phillips Drive bit for aftermarket adjustment
- Box quantities as shown below. Sold in full boxes only.

Length x Gauge	Finish	Box Qty	Item #	Bulk Qty	Item #
Regular Point, .375" Diameter Head					
2-1/2" x 8	Black	-	-	2,000	WW38990
3" x 8	Black	-	-	1,500	WW38995
1-1/8" x 8	Zinc	-	-	6,500	WW82600
2-1/2" x 8	Zinc	-	-	2,000	WW39770
3" x 8	Zinc	-	-	1,500	WW39785
Regular Point, .443" Diameter Head					
2-1/2" X 10	Zinc	500	WW39350	1,500	WW39360
3" X 10	Zinc	500	WW39370	1,500	WW30995
3-1/2" X 10	Zinc	800	WW39385	-	-
2-1/2" X 10	Zinc w/White Head	-	-	1,500	WW39320
3" X 10	Zinc w/White Head	-	-	1,000	WW39335

INSTALLATION SCREWS



For use with Metal Studs

Truss Head Phillips Drive, Fine Thread (2/3 Thread) Needle Point



- #8 gauge needle point for light metal studs and sheetmetal
- Large truss head provides large bearing surface and hides rough screw hole edges
- Case hardened, finishes listed below
- Uses #2 Phillips Drive bits
- Box quantities as shown below. Sold in full boxes only.

Length x Gauge	Finish	Box Qty	Item #
2-1/2" x 8	Zinc with White Head	2,000	WW39140
2-1/2" x 8	Zinc with Zinc Head	2,000	WW39160



For use with Metal Studs

Truss Head Phillips Drive, Fine Thread (Full Thread) #2 Drill Point



- #2 drill point for use on heavier gauge metal studs. Eliminates the need for pilot hole/pre drilling studs
- Large truss head provides large bearing surface and hides rough edges
- Case hardened, finishes listed below
- Uses #3 Phillips Drive bits
- Box quantities as shown below. Sold in full boxes only.

Length x Gauge	Finish	Box Qty	Item #	Bulk Qty	Item #
2-1/2" x 10	Zinc with White Head	500	WW39180	-	-
2-1/2" x 10	Zinc with Zinc Head	-	-	2,000	WW39185



For use with Wood Studs

Truss Head Phillips Drive, Coarse Thread (1/2 Thread) Needle Point



- Deep thread for secure fastening to wood studs
- Large truss head provides large bearing surface and hides rough edges
- 1/2" head allows cabinet to "float" for final adjustment
- Case hardened, finishes listed below
- Uses #3 Phillips Drive bits
- Box quantities as shown below. Sold in full boxes only.

Length x Gauge	Finish	Box Qty	Item #	Bulk Qty	Item #
2-1/2" x 10	Zinc with Sand Head	500	WW37020	-	-
3" x 10	Zinc with Sand Head	500	WW37060	1,000	WW37065
2-1/2" x 10	Zinc with White Head	-	-	1,500	WW37015
3" x 10	Zinc with White Head	-	-	1,000	WW37055
2-1/2" x 10	Zinc with Zinc Head	-	-	1,500	WW37045
3" x 10	Zinc with Zinc Head	500	WW37075	-	-

A
B
C
D
E
F
G
H
I
J
K
L
M
N
O
P
Q
R
S
T
U
V
W
X
Y

A
B
C
D
E
F
G
H
I
J
K
L
M
N
O
P
Q
R
S
T
U
V
W
X
Y

INSTALLATION/TRIM SCREWS



Oversized Flat Head Drive, Coarse Thread, Type 17 Auger Point

- Fastcap PowerHead Screws for wood or metal studs
- Head diameter of 9/16" (.5625")
- Case hardened, finishes listed below
- Uses #2 Square or Torx drive bits
- Box quantities as shown below. Sold in full boxes only.

Learn more
about
PowerHead
Screws!



Length x Gauge	Finish	Box Qty	Item #	Bulk Qty	Item #
Square Drive, Wood Studs					
2-1/2" x 8	Black	150	FAPHZ2-1/2-150BL	-	-
3" x 8	Black	150	FAPHZ3-150BL	-	-
1-1/4" x 8	Zinc	200	FAPHZ1-1/4-200	-	-
2-1/2" x 8	Zinc	150	FAPHZ2-1/2-150	1,500	FAPHZ2-1/2-1500
3" x 8	Zinc	150	FAPHZ3-150		
Torx Drive, Wood Studs					
1-1/4" x 8	Zinc	200	FAPHZ1-1/4-200TRX	-	-
2-1/2" x 8	Zinc	150	FAPHZ2-1/2-150TRX	1,500	FAPHZ2-1/2-1500TRX
3" x 8	Zinc	150	FAPHZ3-150TRX	-	-
3-1/2" x 8	Zinc	100	FAPHZ3-1/2-100TRX	-	-
4" x 8	Zinc	100	FAPHZ4-100TRX	-	-
Square Drive, Metal Studs					
3" x 8	Zinc	-	-	1,500	FAPHZ3ME-1500
Torx Drive, Metal Studs					
3" x 8	Zinc		-	1,500	FAPHZ3ME-1500TRX



Trim-It Screws, Square Drive, Twinfast Thread, Sharp Point

- Normally used for fastening trim moldings or jams
- Extremely small head (7/32") is hardly seen; can be countersunk and puttied over
- Type "A" point is very sharp and eliminates pre-drilling in most materials
- Case hardened, Black
- #6 screws use #1 Square Drive bits; #8 screws use #2 Square Drive bits
- Box quantities as shown below. Sold in full boxes only.

Length x Gauge	Finish	Box Qty	Item #
1-5/8" x 6	Black	1,000	WW24010
2-1/4" x 6	Black	1,000	WW24120
3" x 8	Black	100	WW24200

DRYWALL SCREWS



Bugle Head Phillips Drive Coarse Thread, Sharp Point

- Fully threaded
- Case hardened, Black
- Uses #2 Phillips Drive bits
- Box quantities as shown on right.
Sold in full boxes only.

Length x Gauge	Finish	Box Qty	Item #	Bulk Qty	Item #
1" x 7	Black	1,000	WW19000	10,000	WW19010
1-1/8" x 7	Black	-	-	10,000	WW19110
1-1/4" x 7	Black	1,000	WW19200	8,000	WW19210
1-5/8" x 7	Black	1,000	WW19300	5,000	WW19310
2" x 7	Black	1,000	WW19400	3,500	WW19410
2-1/4" x 7	Black	1,000	WW19500	3,000	WW19510
2-1/2" x 8	Black	1,000	WW21000	2,500	WW21100
3" x 8	Black	-	-	2,000	WW21400
4" x 10	Black	1,000	WW29340	-	-

Bugle Head Square Drive, Coarse Thread, Sharp Point



- Fully threaded
- Case hardened, Black
- Uses #2 Square Drive bits
- Box quantities as shown below. Sold in full boxes only.

Length x Gauge	Box Qty	Item #	Bulk Qty	Item #
1" x 7	1,000	WW22000	-	-
1-5/8" x 7	1,000	WW22300	5,500	WW22400
2-1/2" x 8	-	-	3,000	WW22700
3" x 9	1,000	WW23200	2,000	WW23300



Bugle Head Phillips Drive, Fine Thread, Sharp Point

- Fully threaded the length of the screw
- Case hardened, Black
- Uses #2 Phillips Drive bits
- Box quantities as shown below. Sold in full boxes only.

Length x Gauge	Finish	Box Qty	Item #
1-1/4" x 7	Black	8,000	WW29200
1-5/8" x 7	Black	5,000	WW29220
2" x 7	Black	3,500	WW29240
3" x 8	Black	2,000	WW29280
3-1/2" x 10	Black	1,500	WW29300
4" x 10	Black	1,000	WW29320

A HINGE, SLIDE & HARDWARE SCREWS

B
C
D
E
F
G
H
I
J
K
L
M
N
O
P
Q
R
S
T
U
V
W
X
Y



Truss Head Phillips Drive, Coarse Thread Type 17 Auger Point



- Large truss head reduces sinking of head in soft woods
- Designed to prevent splitting in hardwoods when attached into or near the edge of material
- Case hardened, finishes listed below
- Uses #2 Phillips Drive bits
- Box quantities as shown below. Sold in full boxes only.

Length x Gauge	Finish	Box Qty	Item #	Bulk Qty	Item #
5/8" x 8	Zinc	1,000	WW58120	10,000	WW58130
3/4" x 8	Zinc	1,000	WW58140	10,000	WW58150
5/8" x 8	Antique English	1,000	WW59120	10,000	WW59130



Truss Head Recex (Combo Phillips & Square) Drive Coarse Thread, Extra Long Type 17 Auger Point



- Extra long aggressive cutting point that cuts through the toughest materials
- Elongated cutting flute greatly reduces splitting and cracking
- Case hardened, Zinc
- Uses #2 Square Drive bits for insertion and #2 Phillips Drive bits for aftermarket adjustment
- Box quantities as shown below. Sold in full boxes only.

Length x Gauge	Finish	Box Qty	Item #	Bulk Qty	Item #
3/4" x 8	Zinc	1,000	WW59000	12,000	WW59050



.303" Diameter Head

Truss Head (Combo Phillips & Square) Drive, Coarse Thread, Regular Point



- Case hardened, Zinc
- Uses #2 Square Drive bits for insertion and #2 Phillips Drive bits for aftermarket adjustment
- Box quantities as shown below. Sold in full boxes only.



.366" Diameter Head

Length x Gauge	Finish	Box Qty	Item #	Bulk Qty	Item #
.303" Diameter Head					
7/16" x 8	Black	1,000	WLTCS7/16X8-BL	-	-
7/16" x 8	Zinc	1,000	WLTCS7/16X8-2C	-	-
.366" Diameter Head					
7/16" x 8	Zinc	1,000	WW44120	5,000	WW44125

HINGE, SLIDE & HARDWARE SCREWS



Truss Head Phillips Drive, Fine Thread, Regular Point



- Case hardened, Zinc
- Uses #2 Phillips Drive bits
- Box quantities as shown below. Sold in full boxes only.

Length x Gauge	Std Box Qty	Item #
1/2" x 7	1,000	BST1/2X7-2C



.303" Diameter Head



.366" Diameter Head

Truss Head Low Profile Phillips Drive Coarse Thread, Regular Point



- Low Truss Head screw for use on ball bearing slides
- Case hardened, finishes listed below
- Uses #2 Phillips Drive bits
- Box quantities as shown below. Sold in full boxes only.

Length x Gauge	Finish	Box Qty	Item #	Bulk Qty	Item #
.303" Diameter Head					
7/16" x 8	Zinc	1,000	WLTC7/16X8-2C	5,000	WLTC7/16X8-2C-M5
.366" Diameter Head					
7/16" x 8	Zinc	1,000	WW46000	5,000	WW46005
7/16" x 8	Zinc	-	-	14,000	WW46010
7/16" x 8	Black	1,000	WW46100	5,000	WW46150
7/16" x 8	White	1,000	WW46200	-	-



Type 17 Auger Point



Regular Point

Modified Truss Phillips Drive Coarse Thread, Regular or Type 17 Auger Point



- Uses #2 Phillips Drive bits
- Case hardened, finishes listed below
- Box quantities as shown below. Sold in full boxes only.

Length x Gauge	Finish	Box Qty	Item #	Bulk Qty	Item #
Type 17 Auger Point					
3/4" x 8	Nickel	1,000	WW46300	-	-
Regular Point					
7/16" x 8	Zinc	1,000	SCCSMMA08716R2Z	-	-
1/2" x 8	Zinc	1,000	WW46750	5,000	WW46790

A
B
C
D
E
F
G
H
I
J
K
L
M
N
O
P
Q
R
S
T
U
V
W
X
Y

HINGE, SLIDE & HARDWARE SCREWS

Flat Head Phillips Drive, Fine Thread, Sharp Point



- Steel woodscrews in short sizes for hinges, KD fittings, piano hinges and small assembly
- Holds in both hardwoods and softwoods
- Case hardened, finishes listed below
- Uses #2 Phillips Drive bits



Length x Gauge	Finish	Box Qty	Item #	Bulk Qty	Item #
7/16" x 7	Zinc	-	-	1,000	BSF7/16x7-26
1/2" x 5	Zinc	100	WW40205	1,000	WW40200
1/2" x 6	Zinc	100	-	1,000	WW41100
5/8" x 5	Zinc	100	WW40505	1,000	WW40500
5/8" x 6	Zinc	100	WW41210	1,000	WW41900
5/8" x 6	Zinc	-	-	30,000	WW41200
5/8" x 8	Zinc	100	-	1,000	WW41800
3/4" x 6	Zinc	100	WW41410	1,000	WW41400
3/4" x 8	Zinc	100	WW41955	1,000	WW41950
1/2" x 5	Bright Brass	-	-	1,000	WW40400
1/2" x 6	Bright Brass	-	-	1,000	WW41170
5/8" x 5	Bright Brass	-	-	1,000	WW40700
5/8" x 6	Bright Brass	-	-	1,000	WW41350
1/2" x 5	Antique English	100	WW40305	1,000	WW40300
5/8" x 5	Antique English	100	WW40605	1,000	WW40600
5/8" x 6	Antique English	100	-	1,000	WW41300
5/8" x 5	Black	100	WW40615	1,000	WW40620

Flat Head Phillips Drive, Coarse Thread, Regular Point

- Case hardened, finishes listed on right
- Uses #2 Phillips Drive bits
- Box quantities as shown on right.
Sold in full boxes only.



Length x Gauge	Finish	Box Qty	Item #	Bulk Qty	Item #
1/2" x 6	Antique English	-	-	18,000	WW42000
1/2" x 5	Zinc	1,000	WW42075	5,000	WW42050
5/8" x 5	Zinc	1,000	WW42080	5,000	WW42070
1/2" x 6	Zinc	1,000	WW42100	5,000	WW42150
5/8" x 6	Zinc	1,000	WW42300	5,000	WW42390
5/8" x 6	Zinc	-	-	30,000	WW42400
3/4" x 6	Zinc	1,000	WW42500	5,000	WW43150
1" x 6	Zinc	1,000	WW38120	-	-
1/2" x 6	Nickel	1,000	WW54200	5,000	WW54300
5/8" x 6	Nickel	1,000	WW54375	5,000	WW54380
3/4" x 6	Nickel	1,000	WW54680	5,000	WW54690
1" x 6	Nickel	1,000	WW54900	-	-
5/8" x 7	Nickel	1,000	WW46800	-	-
3/4" x 7	Nickel	1,000	WW43700	5,000	WW43750
5/8" x 7	Zinc	1,000	WL9191	-	-

HINGE, SLIDE & HARDWARE SCREWS



Flat Head Phillips Drive Coarse Thread, Type 17 Auger Point



- Case hardened, Zinc
- Uses #2 Phillips Drive bits
- Box quantities as shown below. Sold in full boxes only.

Length x Gauge	Finish	Box Qty	Item #	Bulk Qty	Item #	Super Bulk Qty	Item #
5/8" x 6	Zinc	1,000	WW43000	5,000	WW43020	30,000	WWDW658T17Z
3/4" x 6	Zinc	1,000	WW43100	5,000	WW54765	-	-



Square Drive, Coarse Thread Regular or Type 17 Auger Point



- Case hardened, finishes listed below
- Uses #2 Square Drive bits
- Box quantities as shown below. Sold in full boxes only.

Length x Gauge	Finish	Box Qty	Item #	Bulk Qty	Item #
Regular Point					
1/2" x 6	Zinc	1,000	WW53100	-	-
Type 17 Auger Point					
5/8" x 6	Zinc	1,000	WW53250	30,000	WW53200
3/4" x 6	Nickel	1,000	WL13649	-	-



Flat Head Recex (Combo Phillips/ Square Drive) Coarse Thread, Regular Point



- Case hardened, Zinc
- Uses #2 Phillips Drive bits for insertion and #2 Phillips Drive bits for aftermarket adjustment
- Box quantities as shown below. Sold in full boxes only.

Length x Gauge	Finish	Box Qty	Item #	Bulk Qty	Item #
1/2" x 6	Zinc	1,000	WW39080	-	-
5/8" x 6	Zinc	1,000	WW39090	15,000	WW39085

A
B
C
D
E
F
G
H
I
J
K
L
M
N
O
P
Q
R
S
T
U
V
W
X
Y

A HINGE, SLIDE & HARDWARE SCREWS



**Flat or Round Head Phillips Drive
Coarse Thread, Sharp Point**



- Case hardened, Nickel
- Uses #2 Phillips Drive bits
- Box quantities as shown below. Sold in full boxes only.

Head Type	Length x Gauge	Finish	Box Qty	Item #
Flat	1/2" x 6	Nickel	500	GF81014
Flat	5/8" x 6	Nickel	500	GF81001
Flat	3/4" x 6	Nickel	500	GF81003
Flat	3/4" x 8	Nickel	500	GF81005
Flat	1" x 6	Nickel	500	GF81004
Round	3/4" x 10	Nickel	500	GF81007



**Undercut Flat Head Phillips Drive,
Coarse Thread, Regular or Type 17 Point**



- Undercut head sits flush in the recessed hole of European drawer slides
- Case hardened, finishes listed below
- Uses #2 Phillips Drive bits
- Box quantities as shown below. Sold in full boxes only.



Length x Gauge	Finish	Box Qty	Item #	Bulk Qty	Item #
Regular Point					
1/2" x 6	Zinc	1,000	WW43250	33,000	WW43255
5/8" x 6	Zinc	1,000	WW43420	30,000	WW43440
Type 17 Auger Point					
5/8" x 6	Antique English	1,000	WLUCP5/8X6-AE	-	-
5/8" x 6	Zinc	1,000	WLUCP5/8X6-2C	5,000	WLUCP5/8X6-2C-M5



Pan Head, Fine Thread, Regular Point



- Steel woodscrews in short sizes for hinges, KD fittings and small assembly
- Holds in both hardwoods and softwoods
- Case hardened, finishes listed below
- Uses #2 Phillips Drive bits
- Box quantities as shown below. Sold in full boxes only.

Length x Gauge	Finish	Box Qty	Item #	Bulk Qty	Item #
1/2" x 6	Zinc	-	-	1,000	WW44060
1/2" x 8	Zinc	-	-	1,000	WW44130
5/8" x 6	Zinc	100	-	1,000	WW44165
1/2" x 6	Antique English	100	WW44000	1,000	WW44050

HINGE, SLIDE & HARDWARE SCREWS



Regular Point



Type 17 Auger Point

Pan Head Phillips Drive, Coarse Thread Regular or Type 17 Auger Point



- Edge application screws are designed to prevent splitting in hardwoods when hardware is attached into or near the edge of the material
- Used with European style face frame hinges, pin and pivot hinges, or with catches and latches.
- Case hardened, finishes listed below
- Uses #2 Phillips Drive bits
- Box quantities as shown below. Sold in full boxes only.

Length x Gauge	Finish	Box Qty	Item #	Bulk Qty	Item #
Regular Point					
5/8" x 10	Nickel	1,000	WW45600	-	-
3/4" x 10	Nickel	1,000	WW45800	9,000	WW45700
1" x 10	Nickel	1,000	WW45810	-	-
Type 17 Auger Point					
5/8" x 10	Nickel	1,000	WW45630	-	-
3/4" x 10	Nickel	1,000	WW45820	9,000	WW45830
1" x 10	Nickel	1,000	WW45880	-	-
5/8" x 6	Antique English	1,000	WW45330	-	-
1/2" x 6	Zinc	1,000	WW45230	-	-
5/8" x 6	Zinc	1,000	WW45340	-	-
5/8" x 8	Zinc	1,000	WW45560	15,000	WW45570
3/4" x 8	Zinc	1,000	WW46500	10,000	WW46520



Washer Head Recex (Combo Phillips & Square) Drive Coarse Thread Type 17 Auger Point



- Edge application screws prevent splitting in hardwoods when hardware is attached into or near the edge of the material. Used with European style face frame hinges, pin and pivot hinges, or with catches and latches
- Case hardened, finishes listed below
- Uses #2 Square Drive bits for for insertion and #2 Phillips Drive bits for aftermarket adjustment
- Box quantities as shown below. Sold in full boxes only.

Length x Gauge	Finish	Box Qty	Item #	Bulk Qty	Item #
5/8" x 8	Zinc	-	-	12,000	WWKW39395S
3/4" x 8	Lubricated	1,000	WW39390	-	-
3/4" x 8	Zinc	1,000	WW55500	10,000	WW55550

A HINGE, SLIDE & HARDWARE SCREWS



Oval Head Phillips Drive, Fine Thread, Sharp Point



- Oval head countersinks like flat head with slightly rounded head
- Steel woodscrews in short sizes for hinges, KD fittings and small assembly
- Holds in both hardwoods and softwoods
- Case hardened, finishes listed below
- Uses #2 Phillips Drive bits
- Box quantities as shown below. Sold in full boxes only.

Length x Gauge	Finish	Box Qty	Item #
5/8" x 5	Zinc	1,000	WW50050



Phillips Drive, Type 17 Auger Point

Modified Washer Head Phillips or Recex (Combo Phillips & Square) Drive, Coarse Thread Type 17 Auger Drive, Drawer Front Adjusting Screw



- 1/2" diameter washer head screw
- Uses #2 Phillips or Square Drive bits
- Case Hardened, Zinc

Recex Drive, Type 17 Auger Point

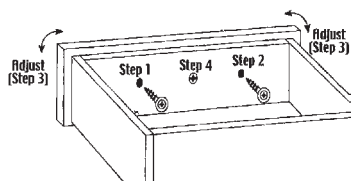

1. Drill oversize 5/16" hole in drawer box.
2. Attach drawer front.
3. Adjust drawer front.
4. Fix drawer front with knob or pull screws.

Length x Gauge	Box Qty	Item #	Box Qty	Item #	Bulk Qty	Item #
Phillips Drive						
1" x 8	100	WW80110	1,000	WW80330	7,000	WW80340
1-1/8" x 8	100	WW80510	1,000	WW80450	6,500	WW80760
1-1/4" x 8	100	WW81810	1,000	WW80750	6,500	WW80930
1-1/2" x 8	-	-	1,000	WW81010	-	-
Recex (Combo Phillips & Square) Drive						
1" x 8	1,000	WW81200	-	-	7,000	WW81300
1-1/8" x 8	1,000	WW81500	-	-	6,500	WW81600
1-1/4" x 8	1,000	WW81800	-	-	6,500	WW81900

EURO / BREADBOARD SCREWS



Flat Head, Pozidrive, 7.2mm Head Diameter



- Case hardened, Nickel
- Uses #2 Pozidrive bits
- Box quantities as shown below. Sold in full boxes only.

Length	Finish	Box Qty	Item #
7.5mm	Nickel	1,000	WW59920
10mm	Nickel	1,000	WW60000
11.5mm	Nickel	1,000	WW60100
13mm	Nickel	1,000	WW60200
14.5mm	Nickel	1,000	WW60300
20mm	Nickel	1,000	WW60420
25mm	Nickel	1,000	WW60520



#2 Phillips Drive



#2 Square Drive

Flat Head, #2 Phillips Or Square Drive 7.5mm Head Diameter



- Case hardened, Nickel
- Box quantities as shown below. Sold in full boxes only.

Length	Brand	Finish	Box Qty	Item #
#2 Phillips Drive				
7.5mm	Grass	Nickel	500	GF83001K
13mm	Würth	Nickel	1,000	WW60260
13mm	Grass	Nickel	500	GF81015K
18mm	Grass	Nickel	500	GF83000K
#2 Square Drive				
13mm	Würth	Nickel	1,000	WW60250

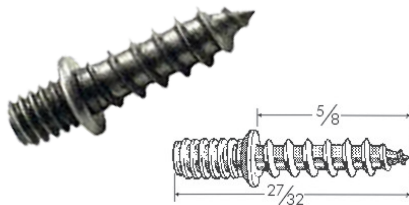

Breadboard Screw

- 8-32 machine screw on one end and #6 x 5/8" wood screw on the other end
- Box quantities as shown below. Sold in full boxes only.



Item #	Box Qty
EPBB-100	25

A DECORATIVE HARDWARE SCREWS

**M4 Thread Machine Screws,
Combo Phillips/Slotted Drive**



- For use with M4 threaded visual hardware
- For surface mounted knobs and pulls it is recommended that the screw length be 6mm (1/4") greater than the material thickness
- Uses #2 Phillips Drive bit
- Box quantities as shown below. Sold in full boxes only.

Length	Finish	Box Qty	Item #
7/8" (22mm)	Zinc	100	WW48340
1" (25mm)	Zinc	100	WW48400
1-3/16" (30mm)	Zinc	100	WW48450
1-3/8" (35mm)	Zinc	100	WW48500
1-5/8" (39mm)	Zinc	100	WW48600
1-3/4" (45mm)	Zinc	100	WW48640

**M4 Thread (Breakaway),
Machine Screws
Combo Phillips/Slotted Drive**

- For use with M4 threaded visual hardware
- 45mm long with break-a-ways at 19mm, 25mm, 32mm, and 38mm
- Uses #2 Phillips Drive bit
- Box quantities as shown below. Sold in full boxes only.

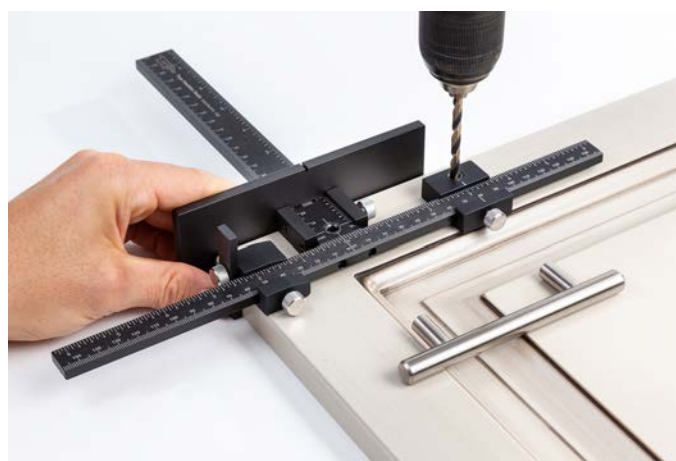
Length	Finish	Box Qty	Item #
1-3/4" (45mm)	Zinc	100	WW48900



**LOOKING FOR HELP WITH
QUICK & EASY INSTALLATION
OF DECORATIVE HARDWARE?
See True Position Jigs in Section U**



DECORATIVE HARDWARE SCREWS



8-32 Thread Machine Screws Combo Phillips/Slotted Drive



- For surface mounted knobs and pulls screw length should be 1/4" greater than the material thickness
- Uses #2 Phillips Drive bit
- Box quantities as shown below. Sold in full boxes only.

Length	Finish	Box Qty	Item #	Bulk Qty	Item #
1/2"	Zinc	100	-	1,000	WW47120
5/8"	Zinc	100	-	1,000	WW46950
3/4"	Zinc	100	-	1,000	WW47130
7/8"	Zinc	100	WW47200	1,000	WW47220
1"	Zinc	100	WW47300	1,000	WW47320
1-1/8"	Zinc	100	WW47400	1,000	WW47420
1-1/4"	Zinc	100	WW47500	1,000	WW47520
1-3/8"	Zinc	100	WW47600	1,000	WW47620
1-1/2"	Zinc	100	WW47700	1,000	WW47720
1-5/8"	Zinc	100	WW47800	1,000	WW47820
1-3/4"	Zinc	100	WW47900	1,000	WW47920
2"	Zinc	100	WW48000	1,000	WW48020



8-32 Thread (Breakaway) Combo Phillips/Slotted Drive



- For use with 8-32 thread visual hardware
- 1-3/4" long with break-a-ways at 3/4", 1", 1-1/4" and 1-1/2"
- Uses #2 Phillips Drive bit
- Box quantities as shown below. Sold in full boxes only.

Length	Finish	Box Qty	Item #	Bulk Qty	Item #
1-3/4"	Zinc	100	WW48700	1,000	WW48720



Washer Head Phillips Drive, Coarse Thread Fully Threaded



- For use with plastic/nylon handles
- Surface mounted knobs and pulls use screw length 3/8" - 1/2" greater than the material thickness
- Nickel finish
- Uses #2 Phillips Drive bit
- Box quantities as shown below. Sold in full boxes only.

Length x Gauge	Finish	Box Qty	Item #
1-3/4" x 8	Nickel	1,000	WLCT8175

BITS & ACCESSORIES

Drive & Insert Bits

- Assorted sizes Phillips, Square and Pozi bits



Item #	Brand	Magnetic	Screw Size	Overall Length	Sold In
Phillips Drive Bits					
WW614176274	Wurth	No	#1	1"	10 each
WW614176461	Wurth	No	#2	1"	10 each
WW92210	Wurth	No	#2	1"	10 each
AP492	Apex	No	#2	1-5/16"	1 each
WW92220	Wurth	No	#2	2"	10 each
AP492A	Apex	No	#2	2-3/4"	1 each
WW92230	Wurth	No	#2	2-3/4"	10 each
AP492B	Apex	No	#2	3-1/2"	1 each
WL12692	Quickscrews	Yes	#2	3-1/2"	1 pack of 10
WL12694	Quickscrews	Yes	#2	6"	1 pack of 10
WW614176648	Wurth	No	#3	1"	10 each
Phillips Drive Bits - Reduced Shank					
APX446-1	Apex	No	#1	1"	1 each
APX446-2	Apex	No	#2	1"	1 each
WL11759	Quickscrews	No	#2	1"	1 pack of 10
Pozi Drive Bits					
WW614176652	Wurth	No	#2	1"	10 each
AP492A-PZD	Apex	No	#2	2-3/4"	1 each
WW614176653	Wurth	No	#3	1"	10 each
Pozi Drive Bits - Reduced Shank					
APX446-2PZD	Apex	No	#2	1"	1 each
Square Drive Bits					
AP950-1	Apex	No	#1	1"	1 each
WW90210	Wurth	No	#2	1"	1 each
BL29050	Bosch	No	#2	1"	1 each
WL12695	Quickscrews	Yes	#2	1-15/16"	1 pack of 10
AP950-2	Apex	No	#2	2"	1 each
WW90220	Wurth	No	#2	2"	1 each
WL12696	Quickscrews	Yes	#2	2-3/4"	1 pack of 10
WW90230	Wurth	No	#2	3"	1 each
WL12697	Quickscrews	Yes	#2	3-1/2"	1 pack of 10
WW90240	Wurth	No	#2	4"	1 each
WW90260	Wurth	No	#2	6"	1 each
KJD6X2	Kreg	No	#2	6"	1 set of 2
WL12698	Quickscrews	Yes	#2	6"	1 pack of 10
Torx Drive Bits					
FAPH-TORX-2IN	FastCap	No	T20	2"	1 pack of 5
FAPH-TORX-6IN	FastCap	No	T20	6"	1 each

BITS & ACCESSORIES



Painted Square Drive Bits



- Makes it easy to identify the right bit (tip is not painted)

Item #	Color	Fits Screw Size	Overall Length
WW91210	Red	#2	1"
WW91230	Red	#2	3"
WW91260	Red	#2	6"



AW® ASSY DRIVE Bits



- For use with ASSY drive screws

Packing & Sold In: 10 each

Item #	Fits Screw Size	Overall Length
WWAW10	#10 Purple	1"
WWAW20	#20 Orange	1"
WWAW20-2	#20 Orange	2"
WWAW20-6	#20 Orange	6"



See how powerful it is!



Bit Magnet



- Slide over the base of a 1" insert bit, 6" extended bit, or anything in between and the magnetic transfer picks up multiple screws with ease

Item #
FATIPMAG



Insert Bit Holder, Magnetic



- High energy magnet helps alleviate the problem of lost bits

Item#	Overall Length	Brand
APM490-2	2"	Apex
BL40831	2-1/8"	Bosch
WW614176702	3"	Wurth

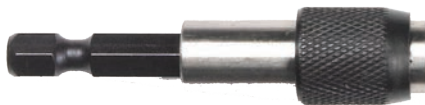

Insert Bit Holder with Quick Change Chuck



- A slight forward motion of the locking sleeve unlocks the bit for a quick change



Item#	Overall Length	Brand
Non-Magnetic		
WW614176711	2"	Wurth

Item#	Overall Length	Brand
Magnetic		
BL48802	2-1/32"	Bosch
WW99010	2-1/4"	Wurth
WW614176708	3"	Wurth

A
B
C
D
E
F
G
H
I
J
K
L
M
N
O
P
Q
R
S
T
U
V
W
X
Y

A
B
C
D
E
F
G
H
I
J
K
L
M
N
O
P
Q
R
S
T
U
V
W
X
Y

BITS & ACCESSORIES / TITE-JOINTS



Insert Bit Holder, Magnetic, One Touch Release



- Soft push on the button, the bit will shoot forward due to the internal spring for easy removal
- Stainless steel housing

Item #
WW614176638



Right Angle Drill Attachment, Magnetic, 1/4" Bit Mount with Quick Change Chuck



- Suitable for use with electric drills and battery operated driver drills
- Specially hardened steel enables maximum torque, with a maximum speed of 2,000 RPM's
- Secure hold and 360° step-free adjustable handle
- Compact design is perfectly suited for screwing in cramped and hard-to-reach places

Item #
WW6149000



Universal Bit Set, 90 Piece, Magnetic



- Includes standard drive styles and safety screws, 1/4" drive magnetic ratchet adapter and sturdy metal box
- Comes in foam insert to keep the bits nicely organized

Item #
WW614250500

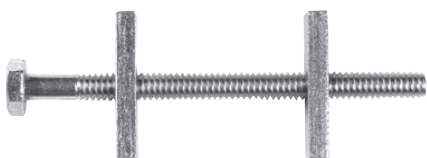

Economy Tite-Joint (Dog Bone) Fasteners



- Hex head
- Ideal for field joints in countertops
- Steel, bright zinc plated
- Box quantities as shown below. Sold in full boxes only.

Item#	Brand	Bolt Size	Box Qty
WW49600	Würth	3-1/2"	100
WW49700	Würth	3-1/2"	500
KV517-100	KV	3-1/2"	100
WW49610	Würth	4"	350
KV513-100	KV	4"	100

TITE-JOINTS

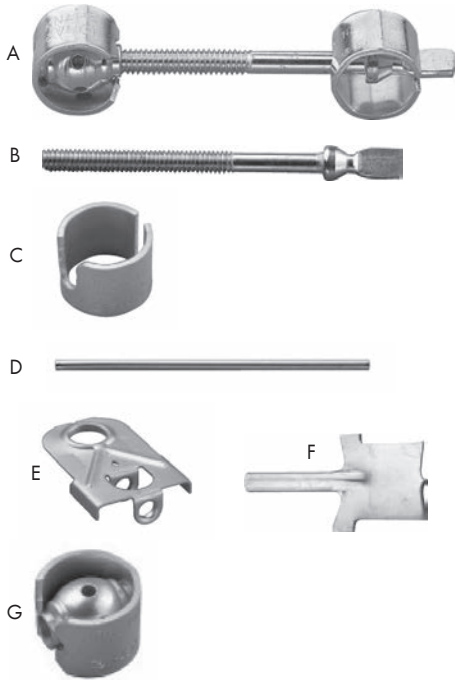

Deluxe Tite-Joint (Dog Bone) Fasteners



- Designed for 3/4" thick substrate
- Center to center 2" to 3-1/2"

Packing: As shown below.

Sold In: Complete Tite Joints sold in full box quantities only.

Components sold in both broken and full box quantities.

	Item #	Description	Box Qty
	WWTJDELUXE-100	Complete Tite Joint, Economy	100
A	KV516-25	Complete Tite Joint	25
	KV516-100	Complete Tite Joint	100
Components			
B	KV516-1	Draw Bolt Only	25
C	KV516-60	Locking Sleeve	25
D	KV516-62	Tightening Rod, KV	1
	WWTR	Tightening Rod, WW	1
E	KV516-63	Drill Guide	4
F	KV516-64	Drill Bit	1
G	KV516-80	Tightening Assembly	25



Zipbolt™ Tite-Joint Fastener



- Integrated gearing system
- Tighten using a 4mm hex drive bit in a drill, hand driver, or Allen key
- Can be tightened in just 3 seconds using the driver bit in a drill
- Each box contains a 4mm hex drive bit
- Box quantities as shown below. Sold in full boxes only.

Item#	Description	Box Qty
SCZIPBOLT	Zipbolt Fastener	60
SC4MMBIT	4mm Hex Drive Bit	1



Flipbolt, Tool-less Draw Bolt



- 4-1/2" long
- Place Flipbolt in cutout (template available), hand tighten nut, Flipbolt tightens when lever is pushed
- Jig works with both sizes of Flipbolt

Item#	Description
FAFLIPBOLT-SHORT	FlipBolt, 3-1/2"
FAFLIPBOLT	FlipBolt, 4-1/2"
FAFLIPBOLTJIG-P	Flip Bolt Template

A
B
C
D
E
F
G
H
I
J
K
L
M
N
O
P
Q
R
S
T
U
V
W
X
Y

A
B
C
D
E
F
G
H
I
J
K
L
M
N
O
P
Q
R
S
T
U
V
W
X
Y

SCREW COVERCAPS



Peel & Stick Plastic Covercaps, PVC



- PVC cover caps come in two diameter sizes; 9/16" and 11/16"
- PSA adhesive backed cover caps, adhesive strength increases as it cures

Covercaps made easy!

Style	Diameter	Color/Species	Box Qty	Item #	Bulk Qty	Item #
Solid Color	9/16"	Almond	265	FAP916AL25	1,060	FAP916AL
Solid Color	9/16"	Antique White	265	FAP916AW25	1,060	FAP916AW
Solid Color	9/16"	Black	265	FAP916BL25	1,060	FAP916BL
Solid Color	11/16"	Black	720	FAP1116BL	-	-
Solid Color	9/16"	Fog Gray	265	FAP916DG25	1,060	FAP916DG
Solid Color	9/16"	Folkstone	265	FAP916LG25	1,060	FAP916LG
Solid Color	11/16"	Folkstone	720	FAP1116LG	-	-
Solid Color	9/16"	White	265	FAP916WH25	1,060	FAP916WH
Solid Color	11/16"	White	720	FAP1116WH	-	-
Tafisa	9/16"	Chocolate Pear	-	-	1,000	FAP916CP
Tafisa	9/16"	Stargazer	-	-	1,000	FAP916-STARGAZER
Tafisa	9/16"	Summer Flame	-	-	1,000	FAP916SF
Tafisa	9/16"	Sunday Brunch	-	-	1,000	FAP916-SUNDAYBRNCH
Tafisa	9/16"	Tea for Two	-	-	1,000	FAP916-TEAFORTWO
Tafisa	9/16"	Tete-A-Tete	-	-	1,000	FAP916-TETEATETE
Tafisa	9/16"	White Chocolate	-	-	1,000	FAP916-WHITECHOC
Tafisa	9/16"	Weekend Getaway	-	-	1,000	FAP916-WKNDGETAWAY
Woodgrain	9/16"	Clear Maple	265	FAP916CM25	-	-
Woodgrain	9/16"	Dark Mahogany	265	FAP916DM25	-	-
Woodgrain	9/16"	Golden Oak	265	FAP916GO25	-	-
Woodgrain	9/16"	Hardrock Maple	265	FAP916HM25	1,060	FAP916HM
Woodgrain	11/16"	Hardrock Maple	720	FAP1116HM	-	-
Woodgrain	9/16"	Knotty Pine	265	FAP916KP25	-	-
Woodgrain	9/16"	Light Maple	265	FAP916LM25	-	-
Woodgrain	9/16"	Light Oak	265	FAP916LO25	-	-
Woodgrain	9/16"	Medium Cherry	265	FAP916MC25	-	-
Woodgrain	9/16"	Natural Cherry	265	FAP916NC25	1,060	FAP916NC
Woodgrain	9/16"	Presidential Walnut	265	FAP916PW25	1,060	FAP916PW
Woodgrain	9/16"	Red Mahogany	-	-	1,060	FAP916RDM
Woodgrain	9/16"	Select Cherry	265	FAP916SC25	-	-

SCREW COVERCAPS



Peel & Stick Covercaps, Real Wood



- PSA adhesive on back of each cover cap, increases in strength as it cures
- Unfinished wood caps can be sanded, stained and finished
- Prefinished real wood cover caps are finished with clear, non-yellowing laquer

Note: Image is PVC, Caps listed below are real wood.

Style	Diameter	Species	Box Qty	Item #	Bulk Qty	Item #
Prefinished Wood	9/16"	Birch	260	FAPW916B25	1,040	FAPW916B
Prefinished Wood	9/16"	Maple	260	FAPW916M25	1,040	FAPW916MP
Prefinished Wood	9/16"	Red Oak	260	FAPW916RO25	-	-
Unfinished Wood	9/16"	Alder	260	FAW916AD25	-	-
Unfinished Wood	9/16"	Cherry	260	FAW916CH25	1,040	FAW916CH
Unfinished Wood	9/16"	Maple	260	FAW916MP25	1,040	FAW916MP
Unfinished Wood	9/16"	Natural Birch	260	FAW916NB25	1,040	FAW916NB
Unfinished Wood	9/16"	Red Oak	260	FAW916RO25	1,040	FAW916RO
Unfinished Wood	9/16"	Walnut	260	FAW916WA25	-	-
Unfinished Wood	9/16"	White Birch	260	FAW916WB25	-	-

Micro Flushmount Drill Bit System, For Fastcap Covercaps



- Unique ball bearing stop collar that controls the recess depth the drill creates and allows the stop collar to stop spinning when it comes in contact with the surface you are drilling
- Both pilot bit (1/8") and countersink bit (9/16") are adjustable
- 9/16" countersink allows you to perfectly flush screws and covercaps
- Micro adjust locking thumb screw



Item #	Description
FAFCDBCB9/16	Flushmount Bit, 9/16"
FAFCINNERBIT	Replacement Inner Bit

A

SCREW COVERCAPS

B

C

D

E

F

G

H

I

J

K

L

M

N

O

P

Q

R

S

T

U

V

W

X

Y



FAPUNCHSET

Custom Color Covercaps Tool



- Punch your own custom color Fastcap covercaps
- For use punching .018 to .022 thick edgbanding and veneer
- Not recommended to use for punching plastic laminate
- FAPUNCHSINGLE includes: carrying case, 3/8", 9/16", 1 1/16" diameter dies; hole punch tool; sample of 3" wood and metal PowerHead screws; 50' 1" SpeedTape
- FAPUNCHSET includes all of the above plus the FlushMount drill bit

Item#	Description
FAPUNCHSET	Punch/Drill Kit
FAPUNCHSINGLE	Punch Kit

So easy to make your own custom caps!



Plastic Screw Covercaps For Phillips Drive Screws



- Knock in cover caps for #6 & #8 screws
- Box quantities as shown below. Sold in full boxes only.

Color	Box Qty	Item #
Almond	1,000	TT1020ALM
Black	1,000	TT1020BLK
Dark Brown	1,000	TT1020DBRN
Light Brown	1,000	TT1020LBRN
White	200	TT1020WH-C2
White	1,000	TT1020WH



Pocket-Hole Plugs



- Use when pocket-holes won't be hidden on the backside of a project or for decorative use
- 50 plugs per pack

Item #	Material	Color/Species
KJCAP-WHT-50	Plastic	White
KJP-MAP-50	Solid Wood	Maple
KJP-OAK-50	Solid Wood	Oak
KJP-PIN-50	Solid Wood	Pine
KJP-PNT-50	Solid Wood	Paint Grade

SCREW COVERCAPS / FINISHING WASHERS

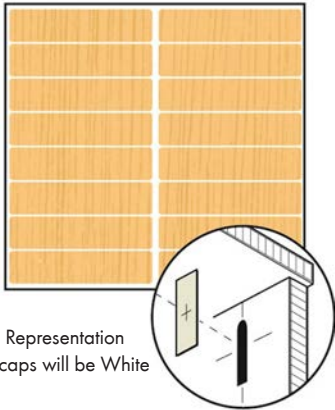

Note: Representation only; caps will be White

**Covercaps For Pocket Cutter Holes
Self-Adhesive PVC**



- Designed for covering holes bored by pocket hole cutters
 - Overall size: 2-1/2" L x 9/16" W
- Packing: Box contains 320 covercaps.
Sold In: Full box quantities only.

Item#	Material	Color
FAP91625WH	PVC	White

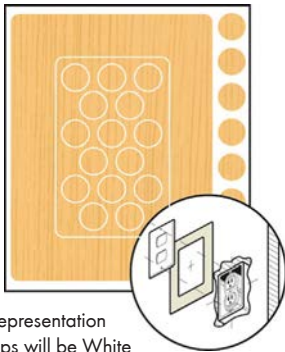

Note: Representation only; caps will be White

Electrical Box Trim, Self-Adhesive PVC



- Overall size: 4-1/8" W x 5-9/16" H
 - Designed to trim the cutout for a standard size (2-1/4" wide x 3-3/4" high) plastic electrical box
- Packing: Contains (1) electrical box trim ring and (23) 9/16" diameter white Fastcap cover caps.
Sold In: Full box quantities only.

Item#	Material	Color
FAPE1WH5	PVC	White

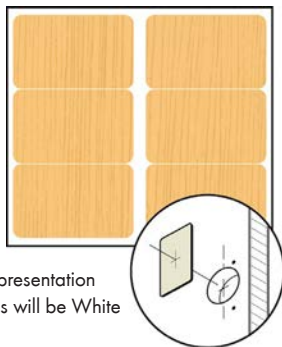

Note: Representation only; caps will be White

**Covercaps For 35mm Hinges,
Self-Adhesive PVC**



- Designed to cover unused or misplaced holes bored in doors for European hinges
 - Covercap measures 1-9/16" Wide by 2-1/2" Long
 - Material is .020" thick PVC, White finish
- Packing: Box contains 30 covercaps. Full box quantities only.

Item#	Material	Color
FAPH25WH5	PVC	White



Finishing Washer



- Provides a clean, finished look for flat head screws
- Box quantities as shown below. Sold in full boxes only.

Item#	Material	Fits Screw Size	Finish	Box Qty
WW49025	Steel	#6	Nickel	1,000
WW49175	Steel	#8	Black	1,000
WW49125	Steel	#8	Nickel	1,000
WW49400	Steel	#10	Nickel	1,000

A
B
C
D
E
F
G
H
I
J
K
L
M
N
O
P
Q
R
S
T
U
V
W
X
Y

A MIRROR/BACKSPLASH CLIPS

B
C
D
E
F
G
H
I
J
K
L
M
N
O
P
Q
R
S
T
U
V
W
X
Y

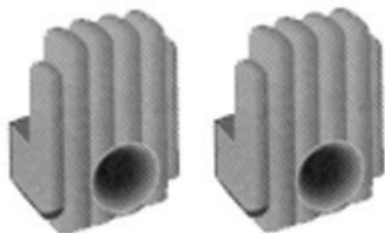

Plastic Mirror Clips

- Use to attach mirrors to walls or cabinets
- Clear for use against any color
- Screws included
- Box quantities as shown below. Sold in full boxes only.



Item#	For Material Thickness	Box Qty
KV6094PLAS	1/8"	100
KV6092PLAS	1/4"	150



Metal Mirror Clips

- Anochrome finish
- Use to attach mirrors to walls or cabinets
- 1/2" wide
- Screws not included
- Box quantities as shown below. Sold in full boxes only.



Item#	For Material Thickness	Box Qty
KV288ANO	1/4"	100



Smart Clip® Backsplash Fasteners

Installing the Smart Clip®:

1. Rout the laminated backsplash.
 2. After measuring and drilling 12" intervals on backsplash, install screws (included) into the bottom of the backsplash.
 3. Install the Smart Clip® on the countertop, butting the wall, using the screws provided.
 4. Run a bead of caulk along the line of Smart Clips®, and drive the backsplash into position.
- Easy to use, install in minutes, are waterproof, and allow formfitting the backsplash of a countertop to nearly any wall surface
 - Eliminates scribing, mastics, metals, and front caulking
 - Box quantities as shown below. Sold in full boxes only.



Backsplash install made easy!

Item#	Description	Box Qty
TJCLIP-L	Smart Clip® 50 Pak	50
TJCLIP	Smart Clip®	250
Accessories		
TJSC1	Router Bit	1
TJ8	Depth Gauge	1
TJ5B	Spacing Bar	1

MISC. FASTENERS

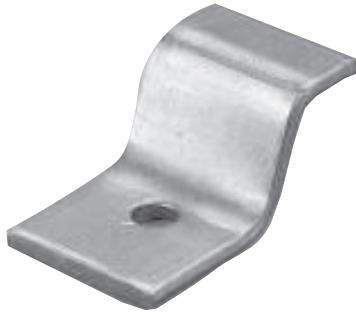

Top Fasteners, Steel

- Ideal for connecting tops made of solid wood where expansion and contraction may be a problem
- The "leg" of the clip "floats" in a saw kerf allowing the top to breathe and not crack
- Uses #5 Flathead screws (not included)
- Box quantities as shown below. Sold in full boxes only.



Item#	Gauge Steel	Width	Finish	Box Qty
KV324	14	3/4"	Steel	100

KV1548



Desk Top Fasteners

- Ideal for mounting tops to legs or table bases
- Screws not included
- Box quantities as shown below. Sold in full boxes only.



Item#	Gauge Steel	Length	Width	Finish	Box Qty
KV1547	12	1-1/4"	3/4"	Steel	100
KV1548	18	1-1/4"	3/4"	Zinc	500



Keyhole Plates

- Used for assembling chairs, beds, cabinets, etc
- Countersunk hole for #6 flat head screws; Rigid connection with #10 round head screws (no screws included)
- .095 gauge cold rolled steel, zinc plated
- Box quantities as shown below. Sold in full boxes only.



Item#	Size	Box Qty
IM67S	1-5/8"L x 9/16"W	500



Interlocking Panel Assembly Hardware Flushmount Hangers

- For wall-panels, wall-hung cabinets, mirrors, bed headboards, and displays
- Two interchangeable interlocking pieces mate perfectly to provide secure fastening in only 1/8" assembled thickness
- Made of .062" gauge steel, zinc plated
- Four screwholes are countersunk for #6 flat head screws (not included)
- Box quantities as shown below. Sold in full boxes only.



Item#	Size	Box Qty
KDFM100B-L	1-1/2"W x 1-3/4"H	50 sets
KDFM100B	1-1/2"W x 1-3/4"H	500 sets

A
B
C
D
E
F
G
H
I
J
K
L
M
N
O
P
Q
R
S
T
U
V
W
X
Y

A
B
C
D
E
F
G
H
I
J
K
L
M
N
O
P
Q
R
S
T
U
V
W
X
Y

MENDING PLATES & BRACES



Mending Plates

- Zinc plated rust resistant steel
- Countersunk screw holes
- Screws not included



Size	Gauge	Recommended Screw Size	# Screw Holes	Item #
2-1/2" L x 5/8" W	16	#5	2	FR225ZC-2-1/2S
3" L x 3/4" W	14	#6	4	FR225ZC-3S



Corner Chair Braces

- Uses 3/4" x #10 flathead wood screws
- Stamped steel, zinc plated finish
- Screws not included (3/4" x 10 flathead)
- Box quantities as shown below. Sold in full boxes only.



Item#	Size	Box Qty
KV342	2" L x 2" W	100



Corner Braces

- Zinc plated rust resistant steel
- Screws not included



Brace Size	Recommended Screw Size	# Screw Holes	Countersunk Holes	Item#
1" L x 1" L x 1/2" H	#6	2	N	FR226ZC-1S
2" L x 2" L x 5/8" H	#6	4	N	FR226ZC-2S
2" L x 2" L x 5/8" H	#6	4	Y	FRB226ZC-2

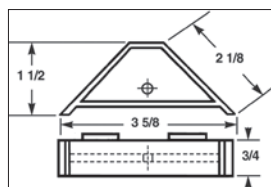
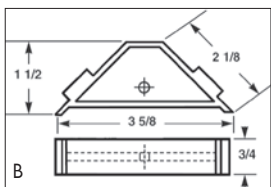
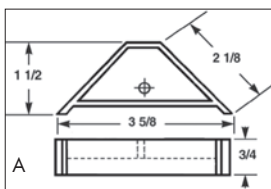

Corner Braces, Plastic Glue Boxes

- Made of high impact, specially compounded plastic material
- Can be stapled through without shattering and will also accept glue
- Off-center screwholes for easier screwgun access into corner of the cabinet
- Braces are 3-5/8" L and 3/4" D
- A) Has no tabs; B) Has tabs extending out; C) Has tabs projecting up
- Screws not included
- Box quantities as shown below. Sold in full boxes only.



	Color	Box Qty	Item #	Bulk Qty	Item #
A	Translucent	100	PGH441E-C	1,200	PGH441E
B	Translucent	100	PGH443E-C	1,200	PGH443E
C	Translucent	100	PGH445E-C	1,200	PGH445E

INTERLOCKING PANEL ASSEMBLY HARDWARE

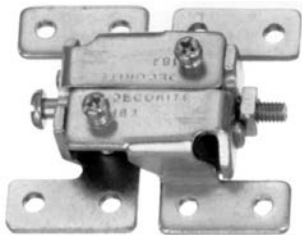

Double Action Levelite Joint Fastener



- Ideal for field joints and other types of sectional clamping
- Draws the edges tight and also levels the two mating surfaces
- Set screws (included) compensate for different thicknesses of material and warping
- Recommended Mounting Screw: 8 each #10 pan heads
- Box quantities as shown below. Sold in full boxes only.

Item#	Box Qty
AV26WS-X	10
AV26WS	50

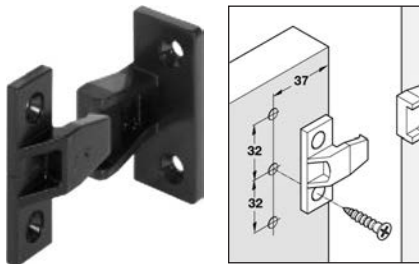

"Keku" Push-In Fittings



- Designed for fastening panels to frames
- Components to be mounted are pushed on from the front eliminating the need for free space at the top or side as required by suspension fittings
- Panel element locks into the frame element as it is pushed home
- Fits 32mm system

Note: Order male and female separately.

Item#	Type
HE262-50-368	Male
HE262-50-359	Female

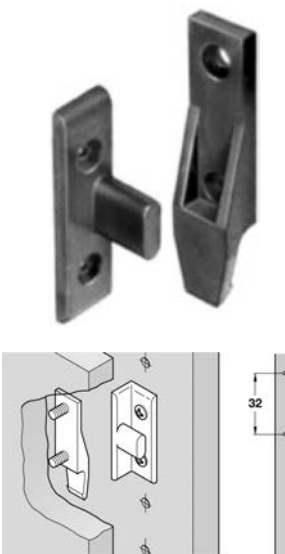
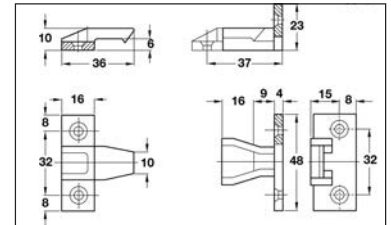

"Keku" Suspension Fittings



- Pre-assembly of sub-frames and cabinet components such as speaker fronts, wainscoting, radiator covers or wherever access is needed after installation
- System consists of a frame and panel element, both made out of a nylon
- If required, suspended panels can be simply released at anytime without special tools
- Fits 32mm systems.

Note: Order male and female separately.

Item#	Type
HE262-49-356	Male
HE262-49-365	Female

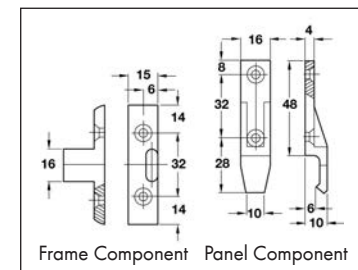

A
B
C
D
E
F
G
H
I
J
K
L
M
N
O
P
Q
R
S
T
U
V
W
X
Y

POST HANGERS, RETAINING CLIPS



Surface Mounted Post Hangers



- 4 male and 4 female pieces per set
- For board widths 4" to 7"; for larger widths, 2 units on each corner may be used for increased rigidity
- Surface mounted brackets require no mortising or machining
- Takes #6 flathead screws (not included)
- Box quantities as shown below. Sold in full boxes only.

Item #	Length	Box Qty
HE271-05-906-P	3-7/8"	1 Set
HE271-05-906	3-7/8"	50 Sets

Post Hangers

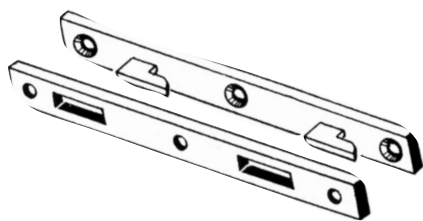

- For beds, booths, removable partitions, shelf brackets, etc.
- 4 male and 4 female pieces per set
- Screws not included: WW41955 (3/4"x8 flathead, box of 200)
- Box quantities as shown below. Sold in full boxes only.

Length	Width	Sets of 4	Set of 4 Item #	Full Box # of Sets	Full Box Item #
3"	5/8"	-	-	12	KD1613
4"	11/16"	1	KD1614-P	6	KD1614
5"	11/16"	1	KD1615-P	6	KD1615
6"	11/16"	-	-	6	KD1616

Glass & Panel Retaining Clips

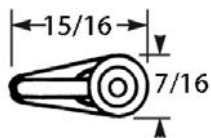

- Holds panels in place and prevents rattling by maintaining a soft pressure against the panel or glass
- Uses #5 flat head or oval head screw
- Made of plastic
- Box quantities as shown below. Sold in full boxes only.

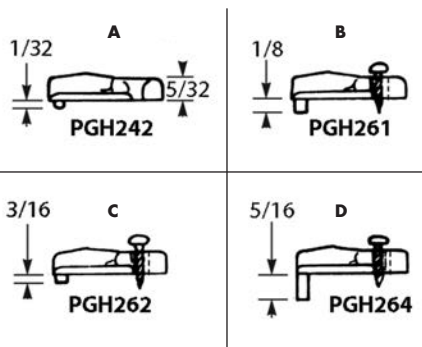

	Application Type	Color	Item #	Item #
A	Flush	Clear	PGH242CL-C	PGH242CL
	Flush	Tan	-	PGH242T
	Flush	Walnut	-	PGH242WAL
B	1/8" Inset	Clear	PGH261CL-C	PGH261CL
	1/8" Inset	Walnut	PGH261WAL-C	PGH261WAL
C	3/16" Inset	Clear	PGH262CL-C	PGH262CL
D	5/16" Inset	Clear	PGH264CL-C	PGH264CL

Z-CLIPS, PANEL HANGING SYSTEM

Z-Clips Interlocking Panel Hanging System

- 2 interlocking aluminum clips; one attaches to the wall (Long Wall Clip) and the other (Short Hang Clip) to the item

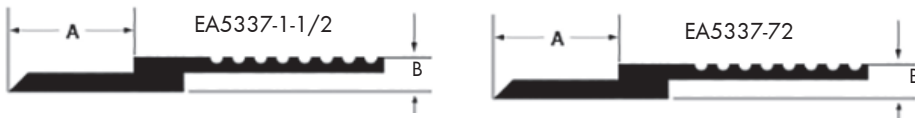

Item #	Description	"A" Size	"B" Size	Overall Size	Holes Per Clip	Box Qty
EA5337-1-1/2	Short Hang Clip	0.625"	0.175"	1.875"W x 1.5"L	2	500
EA5337-72	Long Wall Clip	0.625"	0.175"	1.875"W x 72"L	-	40

Z-Clips Interlocking Panel Hanging System

- 2 interlocking aluminum clips; one attaches to the wall (Long Wall Clip) and the other (Short Hang Clip) to the item

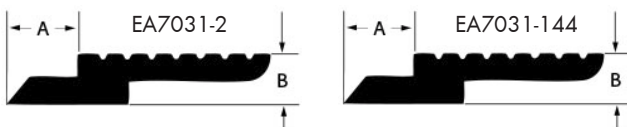

Item #	Description	"A" Size	"B" Size	Overall Size	Holes Per Clip	Box Qty
EA7031-2	Short Hang Clip	0.375"	0.250"	1.375"W x 2"L	2	500
EA7031-144	Long Wall Clip	0.375"	0.250"	1.375"W x 144"L	-	100

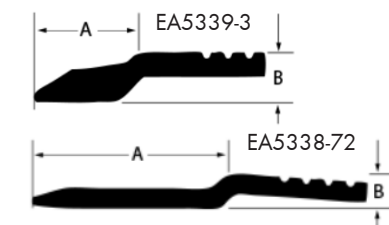

Z-Clips Interlocking Panel Hanging System

- 2 interlocking aluminum clips; one attaches to the wall (Long Wall Clip) and the other (Short Hang Clip) to the item
- EA5339-3 and EA5338-72 are intended to work together



Item #	Description	"A" Size	"B" Size	Overall Size	Holes Per Clip	Box Qty
EA5339-3	Short Hang Clip	0.500"	0.250"	1.25"W x 1.5"L	3	1,000
EA5338-72	Long Wall Clip	0.720"	0.175"	1.875"W x 72"L	-	40

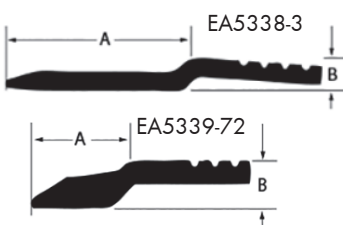

Z-Clips Interlocking Panel Hanging System

- 2 interlocking aluminum clips; one attaches to the wall (Long Wall Clip) and the other (Short Hang Clip) to the item
- EA5338-3 and EA5339-72 are intended to work together



Item #	Description	"A" Size	"B" Size	Overall Size	Holes Per Clip	Box Qty
EA5338-3	Short Hang Clip	0.720"	0.175"	1.25"W x 1.5"L	3	500
EA5339-72	Long Wall Clip	0.500"	0.250"	1.875"W x 72"L	-	40

A
B
C
D
E
F
G
H
I
J
K
L
M
N
O
P
Q
R
S
T
U
V
W
X
Y

WALL ANCHORS/T-NUTS



WW903252



WW903251

Drywall Anchor, Multi-Drive

- Install into 3/8" to 1" wallboard
- Patented drive can be installed with Pozi, AW or Torx bits
- Minimal space requirement behind sheet (only 15mm)
- Use with sheet metal or drywall screws - screws are removable (not included)
- Sold in full boxes of 200 only.



Item#	Material	Length x Gauge
WW903252	Zinc	1-3/8" x 6
WW903251	Nylon	1-3/8" x 6

Drywall Anchor, Phillips Drive

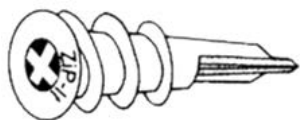

- Install into 3/8" to 1" wallboard with just a Phillips screwdriver
- Use with sheet metal or drywall screws - screws are removable (not included)
- Sold in full boxes of 100 only.



Item#	Material	Length x Gauge
RWNZIP8	Nylon	1-3/4" x 8
RWZZIP8	Zinc	1-3/4" x 8

Wall Anchors, Screw Anchor

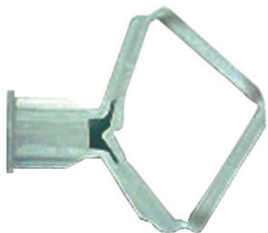

- Screw actuated hollow wall anchor for use in wallboard, solid masonry or hollow doors
- Uses standard sheet metal screws (#6 - #12 not included)
- Sold in full boxes of 100 only.



Item#	Wall Thickness	Drill Diameter
RW2305	5/8"	5/16"



3 Prong Type

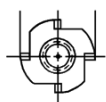

4 Prong Type

T-Nuts

- Simplify joining wood to wood or metal to metal pieces by hammering into drilled holes.
- Prongs prevent turning.
- Box quantities as shown below. Sold in full boxes only.



Thread Size	Bore Hole Diameter	Flange Diameter	Barrel Height	Prong Height	Gauge	Box Qty: 100 Item #	Box Qty: 500 Item #
3 Prong							
8-32	7/32"	1/2"	1/4"	3/16"	.031	-	TN083243
1/4-20	5/16"	3/4"	5/16"	7/32"	.045	TN142053-C	TN142053
5/16-18	3/8"	3/4"	3/8"	1/4"	.052	TN561863T-C	TN561863T
4 Prong							
5/16-18	15/32"	1"	7/16"	11/32"	.062	TN381674T-C	TN381674T

BISCUITS

A
B
C
D
E
F
G
H
I
J
K
L
M
N
O
P
Q
R
S
T
U
V
W
X
Y



Standard Compressed Beech Wood Biscuits

- Flat ends so surplus glue remains inside the groove
- Sold in full boxes of 1,000



PORTER CABLE

Biscuit Size	Excel Dowel Item #	Lamello Item #	Porter Cable Item #
#0	CDBI-0	LM144000	-
#10	CDBI-10	LM144010	RK5552
#20	CDBI-20	LM144020	RK5553



Plastic Biscuits, C-20 Plastic

- Made of translucent C-20 plastic, environmentally friendly polypropylene
- For joining solid surface materials
- No glue required
- Sold in full boxes of 250.



Item#	Biscuit Size	Dimensions
LM156110	C-20 Plastic	23 mm W x 60mm L



Tensio P-14 Connection Fittings



- Self-clamping connector with three functions: alignment, clamping and connecting
- High level of clamping force allows work pieces to be glued without the need for screw clamps or pressure
- Additional option of preloading the connector prior to glue applications enables use for all angles and miters and which reduces the amount of force when connecting the workpieces
- Requires use of Zeta P2 Joiner
- Sold in full box quantities

Item #	Description	Box Qty
LM145415	P-14 Tensio Fittings	80 Sets
LM145425	P-14 Tensio Fittings	300 Sets
LM145435	P-14 Tensio Fittings	1,000 Sets

Item #	Description	Box Qty
LM145426	Tensio Preload Clips	300 Each
LM145436	Tensio Preload Clips	1,000 Each



**No Glue Required =
No Drying Time Required!**

Striplox #20 Biscuits



Made from High Impact Polystyrene, strong fit with a hammer features surface grips to make contact with substrate, will not swell like wooden biscuits for easy installation.

- No need for clamps
- Holds 66 lbs.
- 15mm x 47mm
- Sold in full boxes of 200.

Item #	Color
SJ110-060100	Black

A DOWEL RODS

**Unfinished Smooth
Hardwood Dowel Rods**

- Dowel rods are made of New England hardwoods
 - Dowel rods can be painted, lacquered, varnished, etc.
 - Available in three lengths 3', 4' and 6'
- Sold In: Both broken and full bundle quantities.



3' Smooth Hardwood		
Diameter	Rods per Bundle	Item #
1/8"	100	CD1836
3/16"	100	CD31636
1/4"	100	CD1436
5/16"	100	CD51636
3/8"	100	CD3836
1/2"	50	CD1236
5/8"	25	CD5836
3/4"	25	CD3436
1"	10	CD136
4' Smooth Hardwood		
1/4"	100	CD1448
3/8"	100	CD3848
1/2"	50	CD1248
3/4"	25	CD3448
1"	10	CD148
1-1/4"	10	CD11448
6' Smooth Hardwood		
1"	10	CD172
1-1/4"	10	CD11472
3' Oak		
3/8"	100	CD3836O
1/2"	100	CD1236O

WÜRTH BAER SUPPLY MOBILE APPLICATIONS

A convenient app designed to satisfy all of your needs by putting the power of our website into the palm of your hands!

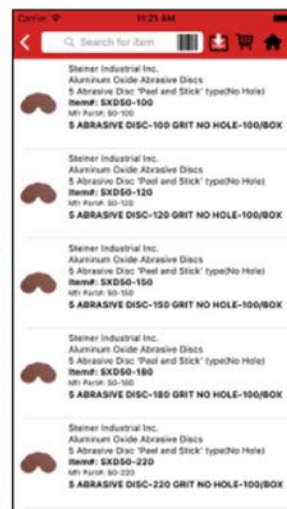
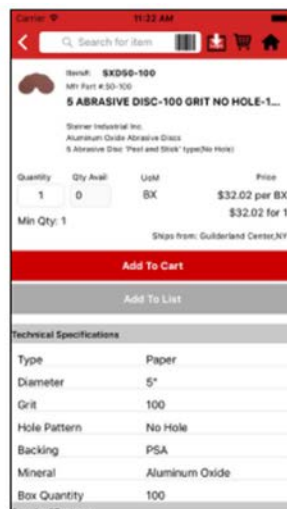
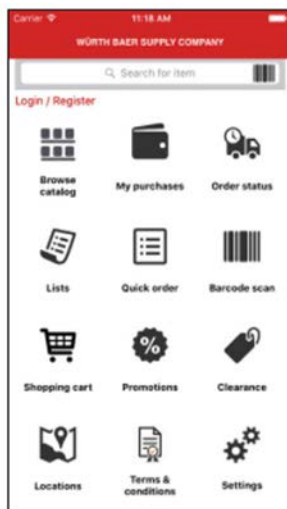

DOWEL PINS



Multi-grooved
Unglued



Multi-grooved
Pre-glued

Fluted Groove Hardwood Dowel Pins

- Available in pre-glued and non-glued versions
- To insert pre-glued versions simply replace glue with water; if inserting by hand, spray hole with water
- Box quantities as shown below. Sold in full boxes only.



Diameter	Length	Species	Bag Qty	Item #	Bulk Qty	Item #
Non-Glued Inch Sizes						
1/4"	1-1/2"	Birch	1,000	CD2500150M	-	-
1/4"	2"	Birch	1,000	CD2500200M	-	-
5/16"	1-3/16"	Birch	1,000	CD3125136M	-	-
5/16"	1-1/2"	Birch	1,000	CD3125150M	-	-
5/16"	2"	Birch	1,000	CD3125200M	-	-
3/8"	1-1/2"	Birch	1,000	CD3750150M	-	-
3/8"	2"	Birch	1,000	CD3750200M	13,000	CD3750200
Non-Glued Metric Sizes						
8mm (5/16")	25mm (1")	Beech	1,000	CD825M	23,000	CD825
8mm (5/16")	30mm (1-3/16")	Beech	1,000	CD830M	19,200	CD830
8mm (5/16")	32mm (1-17/64")	Beech	1,000	CD832M	17,800	CD832
8mm (5/16")	35mm (1-3/8")	Beech	1,000	CD835M	16,400	CD835
8mm (5/16")	38mm (1-1/2")	Beech	1,000	CD838M	15,000	CD838
Pre-Glued Metric Sizes						
8mm (5/16")	30mm (1-3/16")	Beech	1,000	CD830PGM	10,000	CD830PG
8mm (5/16")	32mm (1-1/4")	Beech	-	-	20,000	CD832PG
8mm (5/16")	35mm (1-3/8")	Beech	1,000	CD835PGM	10,000	CD835PG



LOOKING FOR WOOD GLUE? STICK WITH US!

See it all in Section R

A
B
C
D
E
F
G
H
I
J
K
L
M
N
O
P
Q
R
S
T
U
V
W
X
Y

A
B
C
D
E
F
G
H
I
J
K
L
M
N
O
P
Q
R
S
T
U
V
W
X
Y

STRIPLOX FASTENING SYSTEM

Striplox Pro 23

Striplox Pro 23 connectors allow for easy installation and assembly of modern architectural and designer features fixed to walls or ceilings, floating shelves or just connecting and fastening almost any panel products, frames, displays, cabinetry or furniture in seconds – without tools or technical skills and no loose fasteners or glue.

Note: Secure with #8 screws or Liquidlox adhesive (SJ170-020012)

Packing: As shown below. 1 pair equals one male and one female. Sold in full box quantities only.



Item #	Color	Box Qty
SJ101-023103-10	Black	10 Pair
SJ101-023103	Black	100 Pair

Permanent or reversible - simply remove locking tab!

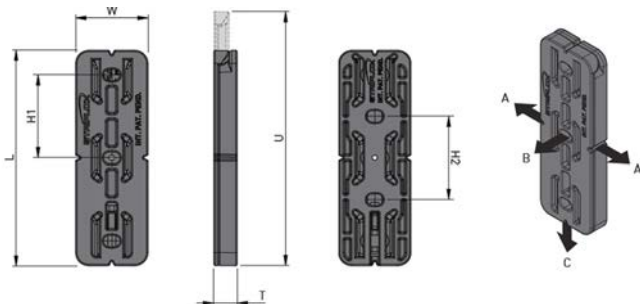

Now available in Minipacks!

Units	Dimensions						Indic. Load Capacity		
	W	D	T	U	H1	H2	A	B	C
Metric (mm/kg)	28	83	9	98	32	32	110	95	160
Imperial (in/lb)	1-1/8	3-1/2	3/8	4-1/8	1-1/4	1-1/4	242	209	352

PERFECT FOR HANGING SHELVING - EVEN FLOATING SHELVES!

Striplox Pro 55

Striplox Pro 55 connectors can be mounted in many different ways to best suit the application.

The design allows for either surface mounting or rebate mounting and can be orientated vertical or horizontal to provide you with a perfect totally hidden fixing.

Note: Secure with #8 screws or Liquidlox adhesive (SJ170-020012)

Packing: As shown below. 1 pair equals one male and one female. Sold in full box quantities only.



Now available in Minipacks!

Item #	Color	Box Qty
SJ101-055103-10	Black	10 Pair
SJ101-055103	Black	50 Pair



Permanent or reversible - simply remove locking tab!

Units	Dimensions						Indic. Load Capacity		
	W	L	T	U	H1	H2	A	B	C
Metric (mm/kg)	45	126	12.8	142	32	32	200	106	200
Imperial (in/lb)	1-25/32	4-31/32	1/2	5-5/8	1-1/4	1-1/4	440	233	440

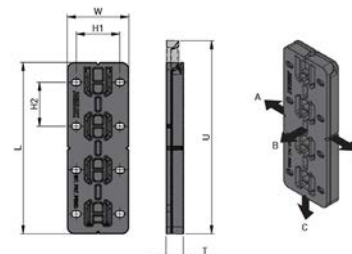

STRIPLOX FASTENING SYSTEM

Striplox Clip 50

Striplox Clip 50 offers an advantage when being used on a less than perfectly square wall with its unique locking system and also having the option of permanent or reusable assembly. The locking key can also swivel for easy lock in positioning.

Note: Secure with #8 screws or Liquidlox adhesive (SJ170-020012)

Packing: As shown below. 1 pair equals one male and one female. Sold in full box quantities only.



Permanent or reversible - simply remove locking tab!

Item #	Color	Box Qty
SJ104-050103-10	Black	10 Pair
SJ104-050103	Black	100 Pair

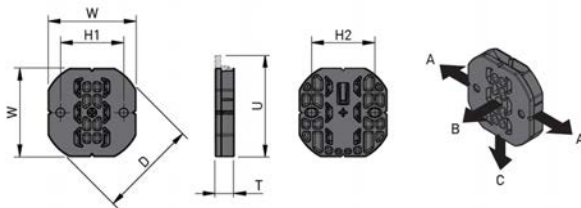

Now available in Minipacks!



Units	Dimensions						Indic. Load Capacity		
	W	D	T	U	H1	H2	A	B	C
Metric (mm/kg)	44.5	49.5	9.5	51	32	32	95	95	125
Imperial (in/lb)	1-3/4	1-61/64	3/8	2	1-1/4	1-1/4	209	209	275



Striplox 90D 98mm

Striplox 90D 98 is the must use connector for achieving the highest level of satisfaction. The Striplox patented design pulls the substrates firmly together to form a strong and tight joint in one simple action by distributing the loads evenly over the entire connector and joint.

Note: Secure with #8 screws

Packing: As shown below. Sold in full box quantities only.



Now available in Minipacks!

Item #	Color	Box Qty
SJ103-098103-10	Black	10 Sets
SJ103-098103	Black	50 Sets
SJ103-098203-10	White	10 Sets
SJ103-098203	White	50 Sets



EASY (AND STRONG) JOINTS!

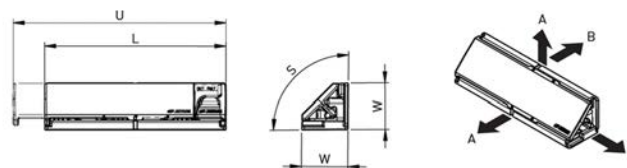

Units	Dimensions						Indic. Load Capacity		
	W	L	S	U	H1	H2	A	B	C
Metric (mm/kg)	25	98	90°	115	32	32	200	66	200
Imperial (in/lb)	1	3-55/64	90°	4-1/2	1-1/4	1-1/4	440	145	440

A
B
C
D
E
F
G
H
I
J
K
L
M
N
O
P
Q
R
S
T
U
V
W
X
Y

A STRIPLOX FASTENING SYSTEM



Striplox Megalox



For applications in substrates from 13mm. Lockable, strong, fixes to substrate with screws. Ideal for toilet partitions, furniture, kitchens, benchtops, etc.

Note: Secure with #8 screws or Liquidlox adhesive (SJ170-020012)

Packing: As shown below. 1 pair equals one male and one female. Sold in full box quantities only.

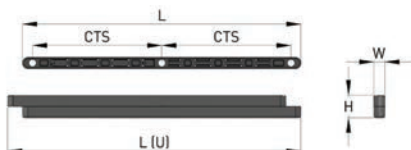

Item #	Color	Box Qty
SJ106-241103-10	Black	10 Pairs
SJ106-241103	Black	50 Pairs

Now available in Minipacks!

Permanent or reversible - simply remove locking tab!

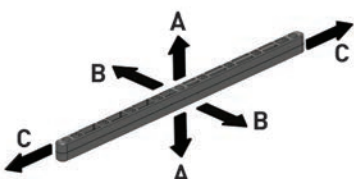

Units	Dimensions					Indic. Load Capacity		
	L	L(u)	CTS	H	W	A	B	C
Metric (mm/kg)	241	254	112	19	9.5	150	295	160
Imperial (in/lb)	9.5	10	4.41	0.75	0.375	330	650	352

B
C
D
E
F
G
H
I
J
K
L
M
N
O
P
Q
R
S
T
U
V
W
X
Y



Striplox 180D



Striplox 180D is designed to join 2 flat surfaces together without routing out for bench top styled connectors. Simply put together in minutes with basic tools; assemble by bringing the 2 hooked halves together to intermesh them, then turn the locking key in to lock tight. Easy to assemble and disassemble for storage or flat pack to freight.

Note: Secure with #8 screws or Liquidlox adhesive (SJ170-020012)

Packing: As shown below. Sold in full box quantities only.



Now available in Minipacks!

Item #	Color	Box Qty
SJ105-114103-5	Black	5 Sets
SJ105-114103	Black	20 Sets
SJ105-114203-5	White	5 Sets
SJ105-114203	White	20 Sets

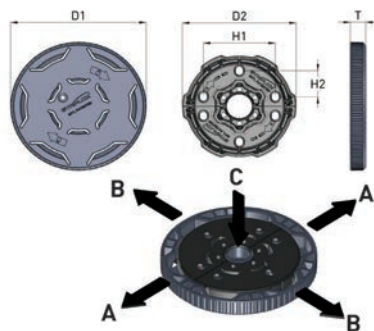

Units	Dimensions					Indic. Load Capacity		
	D1	D2	H1	H2	T	A	B	C
Metric (mm/kg)	114.3	96	60.5	23.3	13	200	230	200
Imperial (in/lb)	4.5	3.78	2.38	0.92	0.51	440	507	440

STRIPLOX FASTENING SYSTEM



Striplox Mini 60

The Mini 60 uses existing methods for installation with no specialized tools required, delivering a fast, strong assembly of components or panels either in the factory, in the home or on site.

Note: Secure with Liquidlox adhesive (SJ170-020012)

Packing: As shown below. 1 pair equals one male and one female. Sold in full box quantities only.

Item #	Color	Box Qty
SJ102-060103-20	Black	20 Pairs
SJ102-060103	Black	200 Pairs

Now available in Minipacks!

Units	Dimensions				Indic. Load Capacity		
	D	L	T	U	A	B	C ¹
Metric (mm/kg)	20	60	7	67.4	90	100	80
Imperial (in/lb)	25/32	2-23/64	9/32	2-21/32	198	176	220

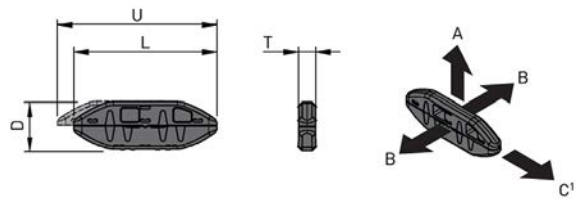

¹ In direction of lock-up.



Striplox Mini 120

The Striplox™ Mini 120 connectors produce a tight and strong joint either in a permanent or reversible configuration making them perfectly suited for commercial, domestic and architectural furniture, kitchen, bathroom and wardrobe cabinetry, commercial fit-outs plus many more applications.

Note: Secure with Liquidlox adhesive (SJ170-020012)

Packing: As shown below. 1 pair equals one male and one female. Sold in full box quantities only.

Item #	Color	Box Qty
SJ102-120103-10	Black	10 Pair
SJ102-120103	Black	100 Pair

Now available in Minipacks!

Units	Dimensions				Indic. Load Capacity		
	D	L	T	U	A	B	C ²
Metric (mm/kg)	19.5	124	7	135	200	146	119
Imperial (in/lb)	19/64	4-7/8	9/32	5-5/16	440	322	262

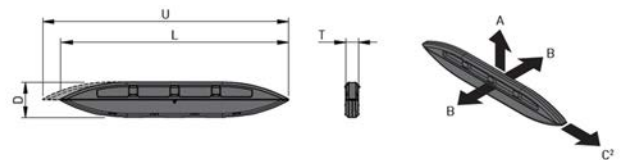

² In direction of lock-up.



Striplox Router Bit, 1/4" Shank

- Produces an accurate and reliable positioning slot or cavity for assembly of Striplox™ products.
- 1/4" shank; Made from Tungsten with carbide cutting head
- 20mm cut height

Item #	Cut Diameter
SJ160-007107	7mm
SJ160-010107	10mm

A STRIPLOX ACCESSORIES



Striplox Liquidlox

High strength fast cure adhesive.



Item #	Size
SJ170-020012	7 oz.

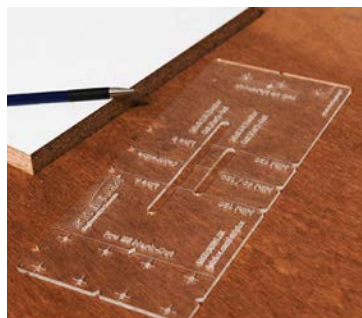

Striplox Template

Speeds up the manufacturing processes by enabling the easy fitment of the Striplox range of joining solutions. The tough and durable clear plastic template features center points, markings, slot guides and can be used as a 3mm packer for the following Striplox products: Pro 55, Pro 23, Clip 50, Mini 60, Mini 120 and 90D 98.



Item #
SJ150-000004

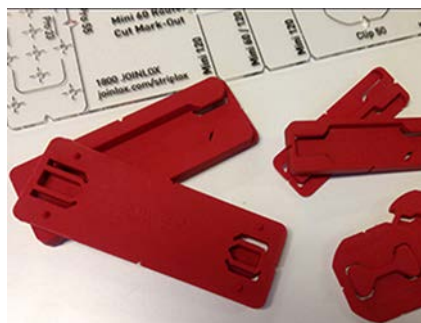

Striplox Jigs

Easily identifiable in red with hardened center points in both components to mark all common substrates allowing for fast and efficient mounting of the Striplox products on the job site.



Item #	For Use With
SJ180-055303	Striplox Pro 55
SJ180-050303	Striplox Clip 50
SJ180-023303	Striplox Pro 23



Striplox Starter Kits Offer A Variety Of Striplox Items To Get You Started!



Item #	Size
SJ136-002002	Small, 48 Pieces
SJ136-001001	Large, 78 Pieces

SJ136-001001 - See What's Included



SJ136-002002 - See What's Included



CONFIRMAT & CONNECTING SCREWS

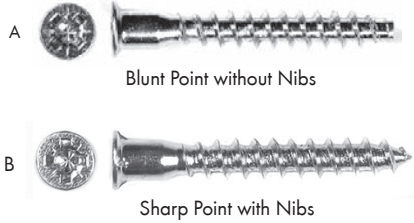

Flat Head With Or Without Nibs, Blunt or Sharp Point, Pozidrive



- Designed for use in case assembly
- Pilot hole diameter 5.4mm, shank dia. 7mm, and Pozidrive head dia. 10mm
- Uses #3 Pozidrive bits
- Box quantities as shown below. Sold in full boxes only.

	Size	Finish	Box Qty	Item #	Bulk Qty	Item #
Blunt Point Without Nibs						
A	7 x 50mm	Zinc	500	WW70480	2,000	WW70450
Sharp Point With Nibs						
B	7 x 50mm	Zinc	-	-	2,000	WW70410

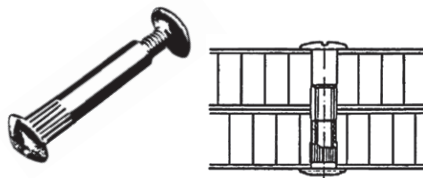

Connecting Screws, 5mm & 8mm Bore - Metal



- Made of corrosion resistant steel, Zinc finish
- Ribbed to prevent rotation while tightening
- 1 set = 1 male and 1 female
- Box quantities as shown below. Sold in full boxes only.

Wood Thickness	Finish	Bore Size	Box Qty	Item #	Bulk Qty	Item #
5mm Bore Size						
1-3/16" - 1-9/16"	Zinc	5mm	100	KD565NP-27-C	500	KD565NP-27
1-3/8" - 1-11/16"	Zinc	5mm	100	KD565NP-35-C	500	KD565NP-35
8mm Bore Size						
1-3/16" - 1-9/16"	Nickel	8mm	100	KD555NP-31-C	500	KD555NP-31
1-7/16" - 1-7/8"	Nickel	8mm	100	KD555NP-37-C	500	KD555NP-37

FIND IT FAST!

Check out our **Screw & Fastener Quickfind** at:
www.wurthbaersupply.com

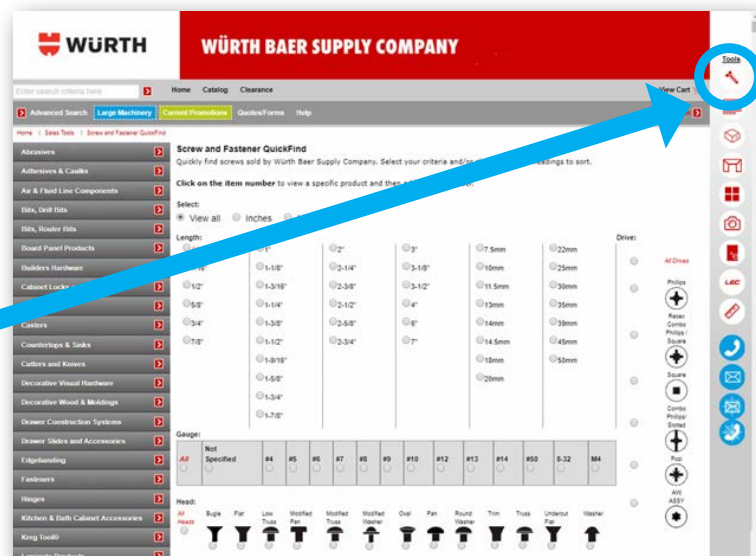

A
B
C
D
E
F
G
H
I
J
K
L
M
N
O
P
Q
R
S
T
U
V
W
X
Y

A TITUS SYSTEM FITTINGS

B
C
D
E
F
G
H
I
J
K
L
M
N
O
P
Q
R
S
T
U
V
W
X
Y

**System 6 Fittings For Closet & Case Goods Construction Drop-On Housings
20mm Diameter, Non-Outrigger & Outrigger**

Titus

- Drop on cams feature a slight lip on the inside to help secure the top shelf until screw is set
- Ideal for use in high volume production
- Can be machine inserted or knocked in with a hammer
- Minimum drilling requirements; no edge boring required
- Linear cam design for constant tightening loads when driving
- Angledrive feature on cam for maximum driving comfort
- Recommended Boring Bits:
Non-Outrigger Cams: AA203201 20mm RH Boring Bit
Outrigger Cams: AA201010 and AA203201 10mm and 20mm RH Boring Bits
- Box quantities as shown below. Sold in full boxes only.

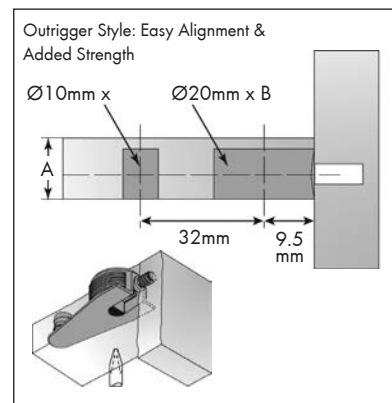
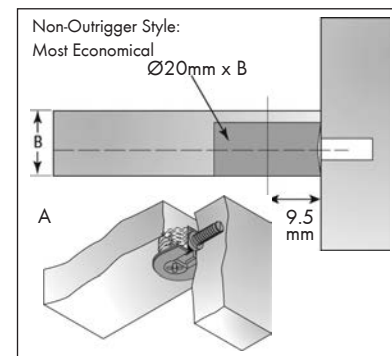
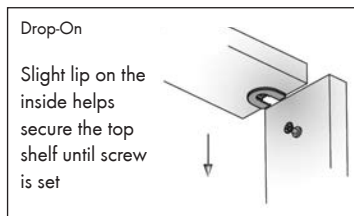

Housing Item#	For Panel Thickness (A)	Drilling Depth (B)	Material	Color/Finish	Bag Qty
Non-Outrigger Style Cams					
TT6387-898	18mm/19mm (3/4")	14mm	Plastic/Zinc	Brown	100
TT6387-877	18mm/19mm (3/4")	14mm	Plastic/Zinc	White	100
Outrigger Style Cams					
TT6439-898	15mm / 16mm (5/8")	12.5mm	Plastic/Zinc	Brown	50
TT6439-877	15mm / 16mm (5/8")	12.5mm	Plastic/Zinc	White	50
TT6397-841	18mm / 19mm (3/4")	14mm	Plastic/Zinc	Almond	50
TT6397-835	18mm/19mm (3/4")	14mm	Plastic/Zinc	Black	50
TT6397-898	18mm / 19mm (3/4")	14mm	Plastic/Zinc	Brown	50
TT6397-927	18mm / 19mm (3/4")	14mm	Plastic/Zinc	Candlelight	50
TT6397-877	18mm / 19mm (3/4")	14mm	Plastic/Zinc	White	50

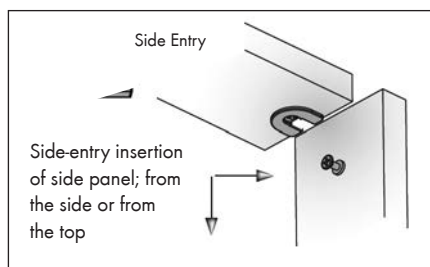

System 6 Fittings For Closet, Case Goods Construction Side Entry Housing, 20mm Diameter Cams & Outrigger

Titus

- Ideal for use in high volume production
- Can be machine inserted or knocked in with a hammer
- Linear cam design for constant tightening loads when driving
- Angle drive feature on cam for maximum driving comfort
- Recommended Boring Bits: AA201010 and AA203201 10mm and 20mm RH Boring Bits
- Box quantities as shown below. Sold in full boxes only.

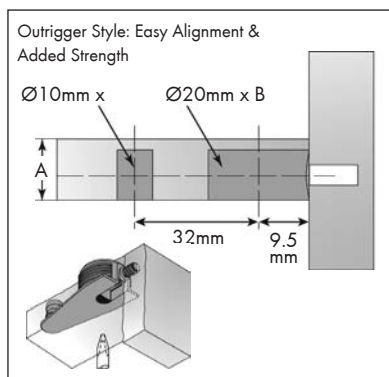

Item#	For Panel Thickness (B)	Drilling Depth (D)	Material	Color/Finish	Bag Qty
Outrigger Style Cams					
TT6395-877	18mm/19mm (3/4")	14mm	Plastic/Zinc	White	50

TITUS SYSTEM FITTINGS

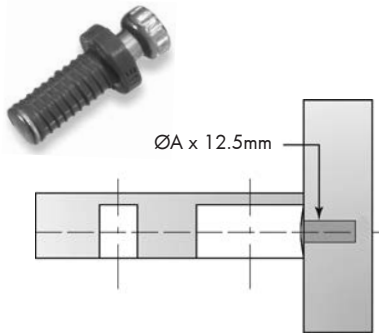

Dowels For Back To Back Or Panel To Panel Applications System 6 Dowels, Push-In Quickfit-Expando For a Tight Joint

Titus

- Can be removed without damage to panel surface
- Plastic expanding sleeve for a secure hold
- Threaded for 5mm system holes
- Depth collar stop for accurate insertion
- Recommended Boring Bit: AA201005 5mm RH Boring Bits
- Box quantities as shown below. Sold in full boxes only.

Dowel Item#	Application	Drilling Diameter For Dowel Thread (A)	Material	Color/Finish	Bag Qty
TT6408-880	Panel To Panel	5mm	Plastic/Zinc	Dark Gray/Zinc	100

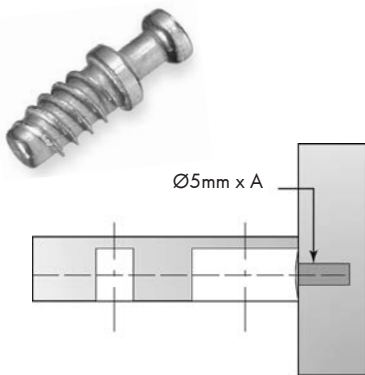

Dowels For Panel To Panel Applications System 6 Dowels, Screw-In

Titus

- Standard screw-in dowel for KD (knock-down) fittings
- Threaded for 5mm system holes
- Dowels feature an integral skirt which acts as a positive stop during insertion
- Recommended Boring Bit: AA201005 5mm RH Boring Bits
- Box quantities as shown below. Sold in full boxes only.

Item#	Drilling Length For Dowel Thread (A)	Material	Finish	Bag Qty
TT6401-885	9mm	Zinc	Zinc	100
TT6406-885	11.5mm	Zinc	Zinc	100

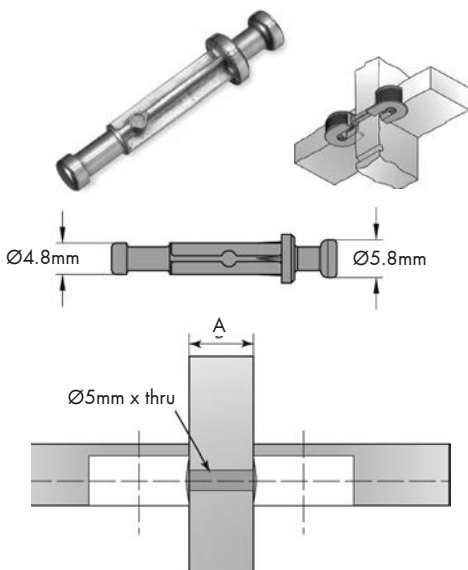

Dowels For Panel Sharing Applications System 6 Dowels Double Ended Push-In

Titus

- Double dowel slides through center panel to lock in shelves on both sides
- Threaded for 5mm system holes
- Available for 18mm/19mm (3/4") panels
- Recommended Boring Bit: AA201005 5mm RH Boring Bits
- Box quantities as shown below. Sold in full boxes only.

Dowel Item#	For Panel Thickness (A)	Material	Finish	Bag Qty
TT6416-885	18mm/19mm (3/4")	Zinc	Zinc	100

A TITUS SYSTEM FITTINGS

B
C
D
E
F
G
H
I
J
K
L
M
N
O
P
Q
R
S
T
U
V
W
X
Y

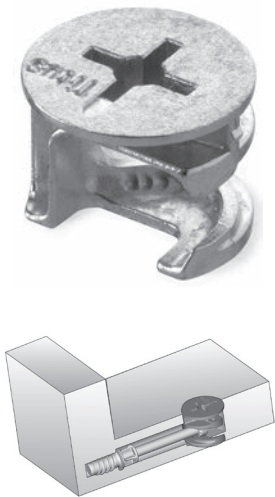

**System 5 Fittings For Panel To Panel Applications
15mm Diameter, 2 Piece (Male/Female)
Component System**

Titus

- Typically used in eurostyle casework , furniture, panel to panel (wood to wood) applications
- Also used as modified case clamps to hold furniture pieces together until glued in dowels dry
- Ensures perfectly aligned joints without rigid drilling restrictions
- "Klix" locking feature provides a strong, vibration proof joint
- Linear cam profile results in smooth, easy cam rotation and dowel pull-up
- Recommended Boring Bit: AA203152 15mm RH Boring Bit
- Box quantities as shown below. Sold in full boxes only.

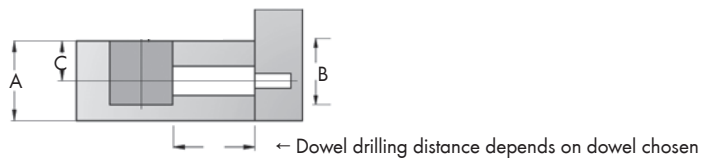

Housing Item#	For Panel Thickness (A)	Drilling Depth (B)	Drilling for Dowel (C)	Material/ Finish	Bag Qty
TT5644-885	18mm/19mm (5/8")	12.7mm	7.5 - 8mm	Zinc	100
TT5656-885	15mm/16mm (3/4")	14mm	9-9.5mm	Zinc	100



**System 5 Dowels For Panel To Panel Applications
Screw-In Combi, Torsion & Pull-Out Resistant**

Titus

- High quality zinc (thread) and steel (pin) dowel with greater resistance to torsion and pull-out
- Steel pin allows magnetic bit use for ease of installation
- "Klix" locking feature provides a strong, vibration proof joint
- Depth stop collar for accurate insertion
- Recommended Boring Bit: AA201005 5mm RH Boring bit
- Box quantities as shown below. Sold in full boxes only.

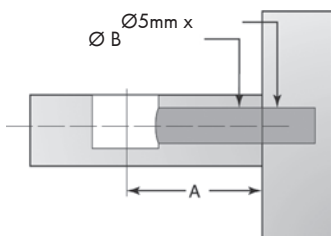

Dowel Item#	Drilling Distance (A)	Drilling Diameter for Dowel Body (B)	Bag Qty
TT9423-885	24mm	7-8 mm	100
TT9424-885	34mm	7-8 mm	100