



QUALITY
CABINETS™





QUALITY

CABINETS™

QUALITYCABINETS TEN-YEAR LIMITED WARRANTY

Masco Cabinetry LLC, is proud of our products and stand behind our quality and workmanship.

As with other natural materials, wood is affected by environmental factors such as natural and artificial lighting, moisture and relative humidity. Darkening or mellowing of the wood can be expected and is a natural part of wood as it ages. Each wood specie also exhibits its own distinctive patterns and characteristics that add to its natural beauty. These variations in color and characteristics are not considered imperfections or defects. This warranty does not cover the natural aging and darkening of wood color, nor does it apply to the inherent growth characteristics of wood. Please review and abide by all storage and installation instructions.

WARRANTY COVERAGE

QualityCabinets products, manufactured and assembled by Masco Cabinetry LLC and purchased from an authorized dealer ("Products"), are warranted to the original purchasing consumer for a period of TEN YEARS from the date of purchase against defective materials or workmanship. This warranty is not transferable.

Should any of the Products prove defective or deficient under normal use for QualityCabinets purchased after August 22, 2016, the defective parts will at our option either be repaired or replaced. In keeping with our continuous product improvement policy, we reserve the right to replace defective parts with parts of equal or greater value.

EXCLUSIONS FROM COVERAGE

This warranty does not cover removal, installation, labor or transportation costs to Masco Cabinetry LLC of the defective Products. Nor does this warranty cover any product used or installed in connection with the cabinets or cabinetwork, such as plumbing fixtures, gas or electrical appliances, or countertops. We shall provide for the cost of the return shipment of repaired or replacement Products to the consumer, if deemed necessary. This warranty does not apply to damages or defects related to improper handling, storage, misuse, alterations, installation or Products used for any purpose other than normal use. Slight color variations for repair or replacement parts and color variations that may occur over time are not considered defects or deficiencies under this warranty.

TO THE EXTENT PERMITTED BY LAW, MASCO CABINETRY LLC SHALL NOT BE LIABLE FOR LOSS OF USE OF THE PRODUCTS, CONSEQUENTIAL, INDIRECT OR INCIDENTAL DAMAGES RESULTING FROM THE USE, INSTALLATION, PERFORMANCE OR FAILURE OF ANY PRODUCTS. Some provinces and some states do not allow the exclusion or limitation of incidental or consequential damages, so the above limitation or exclusion may not apply to you.

This warranty gives you specific legal rights, and you may also have other rights that vary from state to state and from province to province.

WARRANTY CLAIMS

To submit a warranty claim, please write a letter explaining the defect with a copy of your proof of purchase to:

QualityCabinets
Warranty Department
P.O. Box 1946
Adrian, MI 49221

Masco Cabinetry LLC is not responsible for merchandise returned to it without proper written authorization from us.



QUALITY
CABINETS™

Price Book



©2016

Table of Contents

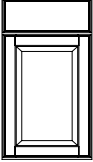
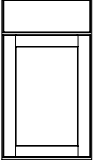
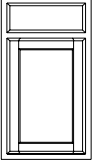
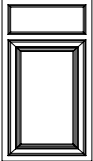
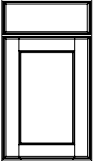
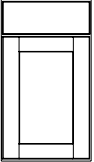
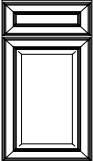
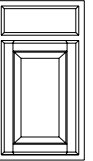
Door Styles	A1-A2	Office Cabinets	H1-H4
Finishes	B1-B2	Office Cabinets	H1
Construction Specifications and Options	C1-C2	Office Accessories	H2-H4
Wall Cabinets	D1-D16	Universal Cabinets	I1-14
Wall Cabinets	D1-D4	Universal Cabinets	I1-I3
Wall Corner Cabinets	D5-D7	Universal Accessories	I3-I4
Wall Open Cabinets	D8	Panels-Shelving-Trays	J1-J4
Wall Appliance Cabinets	D9-D11	Panels	J1
Wall Hoods	D12	Shelving	J2-J3
Wall Accessories	D13-D16	Trays	J4
Base Cabinets	E1-E16	Decorative Enhancements	K1-K10
Base Cabinets	E1-E3	Supports & Valances	K1
Base Sink Cabinets	E4-E7	Moldings	K2-K5
Base Corner Cabinets	E8-E9	Molding Accents	K6
Base Appliance Cabinets	E10-E11	Decorative Hardware Knobs	K7-K8
Base Accessories	E12-E16	Decorative Hardware Pulls	K9-10
Tall Cabinets	F1-F8	Replacement Parts	L1-L16
Tall Cabinets	F1-F4	Touch Up Materials	L1
Tall Appliance Cabinets	F5-F6	Sales Doors	L2
Tall Accessories	F7-F8	Accessories	L3
Vanity Cabinets	G1-G12	Replacement Parts	L4-L8
Vanity Cabinets	G1-G10	Door Style Index	L9
Vanity Accessories	G11-G12	Doors and Drawer Fronts	L10-L13
		Accessory Non-Drilled Doors	L14-L16
		Directory	M1-M4

ITEM	MODEL	ITEM	MODEL	ITEM	MODEL
Felix 	FEL.CH.S.S Cherry Price Column 7	Peterson 	PTN.CH.S.S Cherry Price Column 5	Skylar 	SKY.CH.S.S Cherry Price Column 3
	FEL.MP.S.S Maple Price Column 5		PTN.MP.S.S Maple Price Column 4		SKY.MP.S.S Maple Price Column 2
Gabriel 	GBL.MP.S.S Maple Price Column 3	Reagan 	RGN.MP.S.S Maple Price Column 5	Tobin 	SKY.RO.S.S Red Oak Price Column 1
					TBN.MP.S.S Maple Price Column 6
Lehigh 	LGH.MP.S.5 Maple Price Column 8	Shay 	SHY.CH.S.S Cherry Price Column 6		
			SHY.MP.S.S Maple Price Column 4		
			SHY.RO.S.S Red Oak Price Column 3		

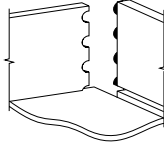
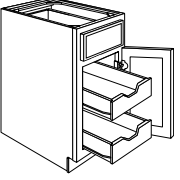
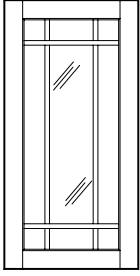
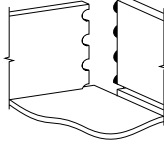
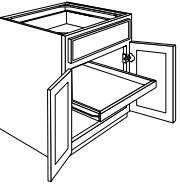
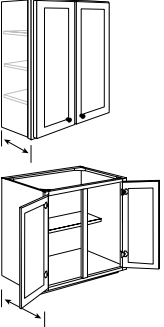
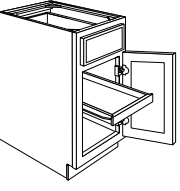
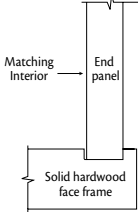
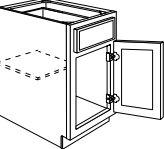
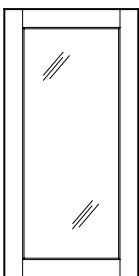
ITEM	MODEL	Price	ITEM	MODEL	Price
Stain Finishes	Amaretto (ARNON) Available on select Cherry door styles	N/C	Painted Finishes	Chiffon (CHNON) Available on select Maple door styles	15%
	Dusk (DSNON) Available on select Maple door styles	N/C		Cotton (CTNON) Available on select Maple door styles	15%
	Kona (KONON) Available on select Maple and Red Oak door styles	N/C		Shale (SENON) Available on select Maple door styles	15%
	Natural (NANON) Available on select Hickory, Maple and Red Oak door styles	N/C	Paint w/Accent Glaze Finishes	Chiffon w/Desert Accent (CHDSA) Available on select Maple door styles	15%
	Pecan (PCNON) Available on select Cherry, Maple and Red Oak door styles	N/C		Chiffon w/Tuscan Accent (CHTNA) Available on select Maple door styles	15%
	Sable (SBNON) Available on select Maple door styles	N/C		Cotton w/Tuscan Accent (CTTNA) Available on select Maple door styles	15%
	Sedona (SDNON) Available on select Maple door styles	N/C	Paint w/Glaze Finishes	Chiffon w/Desert Glaze (CHDSZ) Available on select Maple door styles	20%
	Toffee (TFNON) Available on select Maple door styles	N/C		Chiffon w/Tuscan Glaze (CHTNZ) Available on select Maple door styles	20%
				Cotton w/Tuscan Glaze (CTTNZ) Available on select Maple door styles	20%
Stain w/Accent Glaze Finishes	Natural w/Java Accent (NAJVA) Available on select Maple door styles	15%			
	Sable w/Ebony Accent (SBEBA) Available on select Maple door styles	15%			
	Sedona w/Ebony Accent (SDEBA) Available on select Maple door styles	15%			
	Toffee w/Java Accent (TFJVA) Available on select Maple door styles	15%			
Stain w/Glaze Finishes	Amaretto w/Java Glaze (ARJVZ) Available on select Maple door styles	20%			
	Natural w/Java Glaze (NAJVZ) Available on select Maple door styles	20%			
	Sable w/Ebony Glaze (SBEBZ) Available on select Maple door styles	20%			
	Toffee w/Java Glaze (TFJVZ) Available on select Maple door styles	20%			

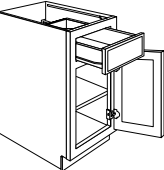
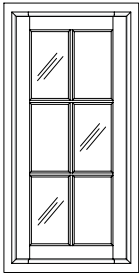
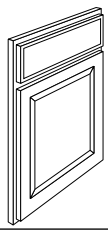
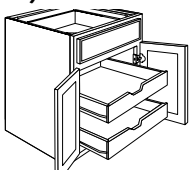
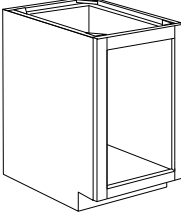
ITEM	MODEL	Price	ITEM	MODEL	Price	ITEM	MODEL	Price
Standard Construction 	SSS	N/C	Deluxe Trays 	2DT	\$250	Prairie Glass Door 	PR	\$250
	SDS	N/C		4DT	\$475		PP	\$200
	Price per Dovetail Drawer +\$60			6DT	\$625		Note: Available on the following door styles: Peterson and Tobin	
	PSS	10%						
	PDS	10%						
Price per Dovetail Drawer +\$60								
All Plywood Construction 	ADT	20%	Standard Full-Width Trays 	1FT	\$75			
	Price per Dovetail Drawer +\$60				2FT	\$150		
Depth Modification 	9	25%	Standard Trays 	1ST	\$50	Matching Interior 	MI	25%
	12	25%		2ST	\$100			
	15	25%		3ST	\$150			
	18	25%		4ST	\$200			
	21	25%		6ST	\$300			
	24	25%						
Half Depth Shelf 	HDS	N/C	Glass Doors 	GD	\$175	Drawer Front  	3	\$60
					PG		\$125	Per drawer front. Optional 3-piece drawer front available in Tobin door style
				Note: Available for the following door styles: Felix, Gabriel, Lehigh, Peterson, Reagan, Skylar, Shay and Tobin			5	\$60
						Per drawer front. Optional 5-piece drawer front is available on Peterson and Reagan door styles		
Full Depth Shelf 	FDS	\$25	Mullion Glass Door 	MG	\$250	Cabinet Front Only 	CFO	-20%
							PM	\$200
				Note: Available on the following door styles: Felix, Gabriel, Reagan, Shay and Skylar				
Deluxe Full-Width Trays 	2DF	\$250				Case Only Option 	CSO	-20%
							Price is off of base price	

Wall Single Door

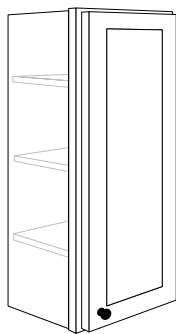

Model	1	2	3	4	5	6	7	8
Specify R or L 18" High								
W2418	209	214	240	257	274	300	334	351
23 1/2" High								
W1224	186	190	213	228	243	266	297	312
W1524	202	207	232	249	265	290	323	340
W1824	221	226	253	271	289	316	353	371
W2124	240	246	276	296	315	345	384	404
W2424	262	269	301	322	344	376	419	440
30" High								
W930	189	193	217	232	248	271	302	317
W1230	206	211	236	253	270	295	329	346
W1530	224	230	257	276	294	322	359	377
W1830	245	251	281	301	321	351	391	411
W2130	267	273	306	328	350	382	426	448
W2430	291	298	333	357	381	417	464	488
36" High								
W936	215	220	247	264	282	309	344	361
W1236	234	240	269	288	307	336	375	394
W1536	256	262	293	314	335	367	408	429
W1836	279	285	320	342	365	400	445	468
W2136	304	311	348	373	398	436	485	510
W2436	331	339	380	407	434	475	529	556
39" High								
W939	229	234	262	281	300	328	366	384
W1239	249	255	286	307	327	358	398	419
W1539	272	278	312	334	356	390	434	457
W1839	296	303	340	364	388	425	473	498
W2139	323	331	370	397	423	463	516	543
W2439	352	361	404	433	462	505	563	591
42" High								
W942	241	247	277	297	317	346	386	406
W1242	263	270	302	323	345	377	421	442
W1542	287	294	329	353	376	411	458	482
W1842	313	320	359	384	410	448	500	525
W2142	341	349	391	419	447	489	545	573
W2442	371	381	426	457	487	533	594	624

Wall Double Door

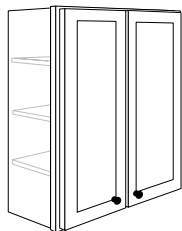

Model	1	2	3	4	5	6	7	8
12" High								
W2712B	215	221	247	265	282	309	344	362
W3012B	226	232	259	278	297	324	361	380
W3312B	237	243	272	292	311	341	380	399
W3612B	249	255	286	307	327	358	398	419
W3912	249	255	286	307	327	358	398	419
W4212	262	268	300	322	343	375	418	440
W4512	275	282	315	338	360	394	439	462
W4812	289	296	331	355	378	414	461	485
15" High								
W2715B	231	237	265	284	303	332	370	389
W3015B	243	249	279	299	318	348	388	408
W3315B	255	261	293	313	334	366	408	428
W3615B	268	274	307	329	351	384	428	450
W3915	268	274	307	329	351	384	428	450
W4215	281	288	323	346	369	403	449	472
W4515	295	302	339	363	387	423	472	496
W4815	310	318	356	381	406	445	495	521
18" High								
W2418B	237	243	272	292	311	341	380	399
W2718B	249	255	286	307	327	358	398	419
W3018B	262	268	300	322	343	375	418	440
W3318B	275	282	315	338	360	394	439	462
W3618B	289	296	331	355	378	414	461	485
W3918	289	296	331	355	378	414	461	485
W4218	303	310	348	373	397	435	484	509
W4518	318	326	365	391	417	456	509	535
W4818	334	342	383	411	438	479	534	561
20 1/2" High								
W3021B	290	297	332	356	380	415	463	487
W3321B	304	312	349	374	399	436	486	511
W3621B	319	327	366	393	419	458	510	537
W3921	319	327	366	393	419	458	510	537
W4221	335	344	385	412	440	481	536	563
23 1/2" High								
W2424B	284	291	326	349	372	407	454	477
W2724B	298	305	342	367	391	428	476	501
W3024B	313	321	359	385	411	449	500	526
W3324B	344	352	395	423	451	493	550	578
W3624B	345	354	396	424	453	495	552	580
W3924	345	354	396	424	453	495	552	580
W4224	362	371	416	445	475	520	579	609
W4524	380	390	437	468	499	546	608	639
W4824	399	409	458	491	524	573	639	671
27" High								
W3027B	331	339	380	407	434	475	529	556
W3327B	347	356	399	427	456	498	555	584
W3627B	365	374	419	448	478	523	583	613
W3927	365	374	419	448	478	523	583	613
W4227	383	392	439	471	502	549	612	644

**Wall Double Door
Continued**

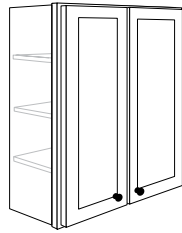

Model	1	2	3	4	5	6	7	8
30" High								
W2430B	316	324	363	389	415	454	505	531
W2730B	332	340	381	408	435	476	531	558
W3030B	349	357	400	429	457	500	557	586
W3330B	366	375	420	450	480	525	585	615
W3630B	384	394	441	473	504	551	614	646
W3930	384	394	441	473	504	551	614	646
W4230	404	414	463	496	529	579	645	678
W4530	424	434	486	521	556	608	677	712
W4830	445	456	511	547	584	638	711	748
36" High								
W2436B	366	375	420	450	480	525	585	615
W2736B	384	393	441	472	504	551	614	645
W3036B	403	413	463	496	529	578	645	678
W3336B	423	434	486	521	555	607	677	711
W3636B	445	456	510	547	583	638	711	747
W3936	445	456	510	547	583	638	711	747
W4236	467	478	536	574	612	670	746	784
39" High								
W2439B	433	444	497	533	568	622	693	728
W2739B	413	423	474	507	541	592	660	693
W3039B	433	444	497	533	568	622	693	728
W3339B	455	466	522	559	597	653	727	765
W3639B	478	489	548	587	627	685	764	803
W3939	502	514	576	617	658	720	802	843
W4239	527	540	604	648	691	755	842	885
42" High								
W2442B	417	428	479	513	547	599	667	701
W2742B	438	449	503	539	575	628	700	736
W3042B	460	471	528	566	603	660	735	773
W3342B	483	495	554	594	634	693	772	812
W3642B	507	520	582	624	665	728	811	852
W3942	507	520	582	624	665	728	811	852
W4242	533	546	611	655	698	764	851	895
Wall Refrigerator 12" High								
WR3012B	256	263	294	315	336	368	410	431
WR3312B	237	243	272	292	311	341	380	399
WR3612B	249	255	286	307	327	358	398	419
WR3912	284	291	326	349	373	408	454	478
WR4212	298	306	342	367	391	428	477	501
15" High								
WR3015B	275	282	316	338	361	395	440	462
WR3315B	255	261	293	313	334	366	408	428
WR3615B	268	274	307	329	351	384	428	450
WR3915	305	313	350	375	400	438	488	513
18" High								
WR3018B	297	304	340	365	389	426	474	499
WR3318B	275	282	315	338	360	394	439	462
WR3618B	289	296	331	355	378	414	461	485

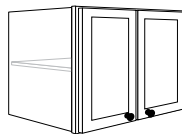

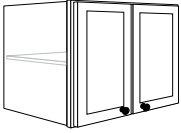
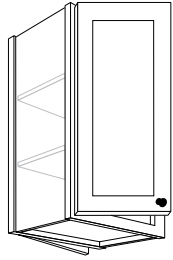
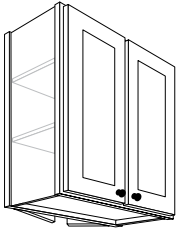
	Model	1	2	3	4	5	6	7	8
Wall Refrigerator Continued 	WR3918	329	337	378	404	431	472	526	553
	WR4218	345	354	396	425	453	496	552	580
	23 1/2" High								
	WR3624B	345	354	396	424	453	495	552	580
	WR3924	393	403	451	484	516	564	629	661
	WR4224	413	423	474	508	542	593	660	694
	27" High								
	WR3627B	365	374	419	448	478	523	583	613
	WR3927	416	426	477	511	545	596	665	699
Peninsula Wall Single Door 	18" High								
	PW2418	329	337	378	405	432	472	526	553
	23 1/2" High								
	PW1824	331	339	380	407	434	475	529	556
	PW2124	361	370	414	443	473	517	576	606
	PW2424	393	403	451	483	516	564	628	661
	30" High								
	PW1830	367	376	421	451	481	526	586	616
	PW2130	400	410	459	492	524	573	639	672
	PW2430	436	447	500	536	572	625	697	732
Peninsula Wall Double Door 	18" High								
	PW2418B	351	359	402	431	460	503	560	589
	PW3018B	406	416	466	499	532	582	649	682
	PW3618B	426	437	489	524	559	611	681	716
	23 1/2" High								
	PW2424B	419	429	481	515	550	601	670	704
	PW3024B	485	497	557	596	636	696	775	815
	PW3624B	509	522	585	626	668	731	814	856
	30" High								
	PW2430B	467	478	536	574	612	670	746	784
	PW3030B	540	554	620	664	709	775	864	908
	PW3630B	567	581	651	698	744	814	907	953

	Model	1	2	3	4	5	6	7	8	
Wall Blind Corner Single Door	Specify BR or BL 23 1/2" High									
	WBC27/3024 BR or BL	250	257	287	308	328	359	400	421	
	WBC36/3924 BR or BL	311	318	357	382	408	446	497	522	
	30" High									
	WBC24/2730 BR or BL	262	268	301	322	344	376	419	440	
	WBC27/3030 BR or BL	269	276	309	331	353	386	430	452	
	WBC30/3330 BR or BL	298	305	342	367	391	428	476	501	
	WBC33/3630 BR or BL	320	328	368	394	420	460	512	538	
	WBC36/3930 BR or BL	359	368	412	442	471	515	574	604	
	36" High									
	WBC24/2736 BR or BL	303	310	347	372	397	434	484	509	
	WBC27/3036 BR or BL	289	296	332	356	379	415	462	486	
	WBC30/3336 BR or BL	345	353	395	424	452	494	551	579	
	WBC36/3936 BR or BL	415	425	476	510	544	595	664	698	
	39" High									
	WBC24/2739 BR or BL	326	334	374	400	427	467	520	547	
	WBC27/3039 BR or BL	311	319	357	382	408	446	497	523	
	WBC30/3339 BR or BL	370	379	425	455	486	531	592	622	
	WBC36/3939 BR or BL	446	457	512	549	585	640	713	750	
	42" High									
	WBC24/2742 BR or BL	350	359	402	430	459	502	559	588	
	WBC27/3042 BR or BL	334	343	384	411	438	480	534	562	
	WBC30/3342 BR or BL	398	408	457	489	522	571	636	669	
	WBC36/3942 BR or BL	480	492	550	590	629	688	767	806	
	Wall Blind Corner Double Door	Specify BR or BL								
		WBC42/4530 BR or BL	414	424	475	509	543	593	661	695
WBC48/5130 BR or BL		455	466	522	560	597	653	727	765	
Peninsula Wall Blind Corner	Specify BR or BL									
	PWBC24/2730 BR or BL	423	433	485	519	554	606	675	710	

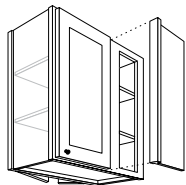
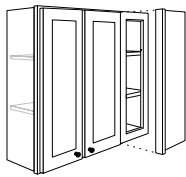
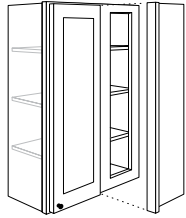

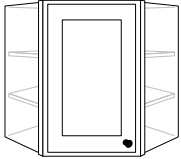
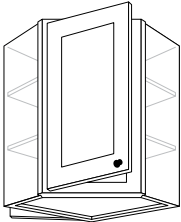
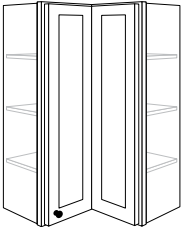
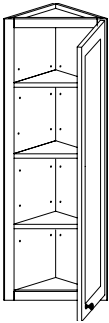
	Model	1	2	3	4	5	6	7	8
Wall Angle Single Door 	Specify R or L 30" High								
	WA2430	371	380	426	457	487	533	593	624
	WA2730	399	409	458	491	523	573	638	671
	36" High								
	WA2436	428	438	491	526	561	613	683	718
	WA2736	460	471	527	565	603	659	735	772
	39" High								
	WA2439	455	466	522	560	597	653	727	765
	WA2739	489	501	561	602	642	702	782	822
	42" High								
	WA2442	484	496	555	595	634	694	773	813
WA2742	520	533	597	639	682	746	831	874	
Peninsula Wall Angle 	Specify R or L								
	PWA2430	599	613	687	736	785	859	957	1006
Wall Easy Reach 	Specify R or L 30" High								
	WEZR2430	441	452	506	543	579	633	705	742
	36" High								
	WEZR2436	510	523	585	627	669	732	815	857
	39" High								
	WEZR2439	548	562	629	674	719	786	876	921
42" High									
WEZR2442	589	604	676	725	773	845	942	990	
Wall Corner Angle 	Specify R or L 30" High								
	WCA1230	339	348	390	417	445	487	543	570
	36" High								
	WCA1236	390	400	448	480	512	560	624	656
	39" High								
	WCA1239	416	426	477	511	545	597	665	699
42" High									
WCA1242	440	451	505	541	577	632	704	740	

Wall End Corner

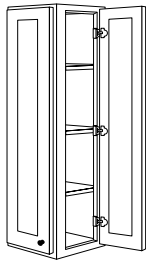

Model	1	2	3	4	5	6	7	8
30" High								
WEC1230	339	348	390	417	445	487	543	570
36" High								
WEC1236	392	402	450	482	515	563	627	659
39" High								
WEC1239	422	432	484	519	553	605	674	709
42" High								
WEC1242	453	465	520	557	595	650	725	762

Bookcase Cabinets

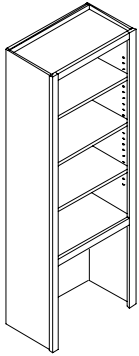

Model	Carton Quantity	Cherry	Maple	Red Oak
12" High				
BK3012	1	280	270	241
BK3612	1	321	310	277
24" High				
BK1524	1	260	251	224
BK1824	1	279	270	241
BK2124	1	300	290	259
BK2424	1	323	312	278
30" High				
BK1530	1	296	286	255
BK1830	1	318	307	274
BK2130	1	342	330	295
BK2430	1	367	355	317
36" High				
BK1536	1	339	327	292
BK1836	1	364	352	314
BK2136	1	391	378	337
BK2436	1	421	406	363
39" High				
BK1539	1	362	349	312
BK1839	1	389	376	335
BK2139	1	418	404	361
BK2439	1	450	434	388
42" High				
BK1542	1	383	370	330
BK1842	1	412	397	355
BK2142	1	442	427	381
BK2442	1	476	459	410
48" High				
BK1848	1	457	441	394
BK2148	1	502	485	433
BK2448	1	553	534	477
54" High				
BK1854	1	494	477	426
BK2154	1	543	525	468
BK2454	1	598	578	516
60" High				
BK1860	1	535	516	461
BK2160	1	588	567	507
BK2460	1	647	625	558

Solid Wood Wall End Open Shelf

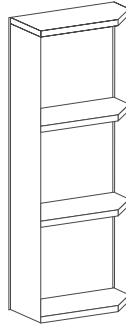

Model	Carton Quantity	Cherry	Maple	Red Oak
SWEOS30	1	212	205	183
SWEOS36	1	244	236	210
SWEOS42	1	284	275	245

Wall China Display



WCD3015	1	500	483	431
WCD3615	1	551	532	475

Wall Lattice

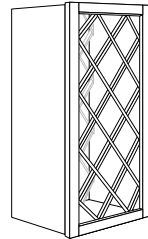
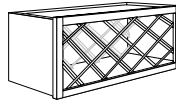

15" High				
WL3015	1	455	439	392
30" High				
WL1530	1	433	418	373

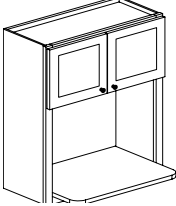
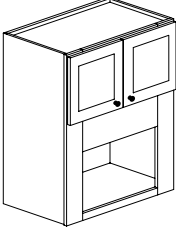
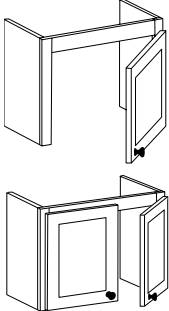
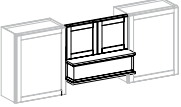
	Model	1	2	3	4	5	6	7	8
Wall Microwave Shelf Cabinet 	24" Wide								
	WMSC2436B	362	371	415	445	474	519	578	608
	27" Wide								
	WMSC2730B	362	371	415	445	474	519	578	608
	WMSC2736B	416	426	477	511	546	597	665	699
	WMSC2742B	476	488	547	586	625	683	761	800
Wall Microwave Cabinet 	18" Deep								
	WMC2736B	513	526	589	631	673	737	821	863
	WMC3036B	534	547	613	657	700	766	854	897
	WMC2745B	497	509	570	610	651	712	794	834
	WMC3045B	516	529	593	635	677	741	825	868
Door Storage Unit 	DOS18	228	234	262	280	299	327	365	383
	DOS24B	239	245	275	294	314	344	383	402
Mantle Hood Front 	MMHF3024B	2170	2223	2490	2667	2845	3112	3468	3645
	MMHF3624B	2321	2379	2664	2854	3044	3330	3710	3901

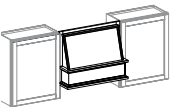
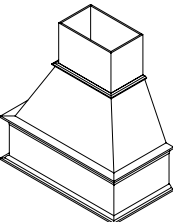
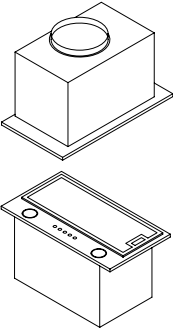
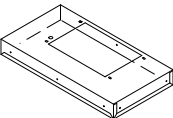
	Model	Carton Quantity	Cherry	Maple	Red Oak
Range Hood Front 	RHF3024	1	1050	1014	905
	RHF3624	1	1123	1085	968
Wall Hood Classic Chimney Plain 	WHCC362442P	1	3146	3037	2712
Wall Hood Blower 	WHB36-620	1	1380	1380	1380
Wall Hood Liner 	WHL36	1	251	251	251

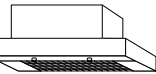
	Model	Carton Quantity	Cherry	Maple	Red Oak
Range Hood Blower and Light Unit 	RHB	1	842	842	842

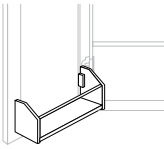
	Model	Carton Quantity	Cherry	Maple	Red Oak
Door Spice Rack 	DSR12	1	51	51	51
	DSR12-2	2	97	97	97
	DSR15	1	53	53	53
	DSR15-2	2	101	101	101
	DSR18	1	57	57	57
	DSR18-2	2	109	109	109

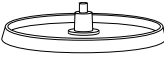
Lazy Susan Revolving Shelf Kit (One Shelf) 	LS1	1	81	81	81

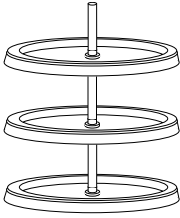
Lazy Susan Revolving Shelf Kit (Three Shelves) 	LS3	1	164	164	164

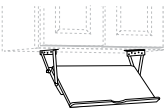
Cookbook Rack Pull-Down 	CRPD	1	244	244	244

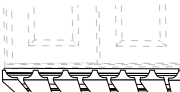
Stem Glass Holder 	SGH30	1	180	174	155
	SGH30-10	10	1708	1649	1473
	SGH36	1	219	212	189
	SGH36-10	10	2084	2012	1796

	Model	Carton Quantity	Cherry	Maple	Red Oak
Under Cabinet Shelf 	UCS36	1	287	277	247

Under Cabinet Corner Shelf 	UCSC2424	1	416	402	359

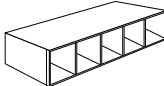
Open Cube Organizer 	OCO18	1	261	252	225
	OCO24	1	271	262	234
	OCO30	1	287	277	248
	OCO36	1	316	305	272

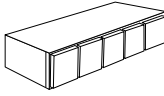
Spice Drawer Organizer 	SDO18	1	645	623	556
	SDO24	1	671	648	578
	SDO30	1	709	685	612
	SDO36	1	774	747	667

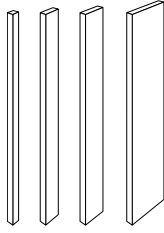
Wall Filler 	1" Wide				
	WF1-30	1	16	16	14
	WF1-30-20	20	309	298	266
	2" Wide				
	WF2-30	1	25	25	22
	WF2-30-10	10	242	234	209
	3" Wide				
	WF3-30	1	37	36	32
	WF3-30-4	4	141	136	122
	WF3-36	1	42	40	36
	WF3-39	1	44	42	38
	WF3-39-4	4	166	161	143
	WF3-42	1	46	45	40
	WF3-42-4	4	176	170	152
	6" Wide				
	WF6-30	1	66	64	57
	WF6-36	1	69	67	60
	WF6-39	1	80	77	69
WF6-42	1	91	87	78	

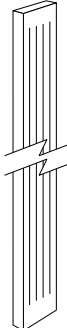
	Model	Carton Quantity	Cherry	Maple	Red Oak
	WFF3-12	1	82	80	71
	WFF3-15	1	87	84	75
	WFF3-18	1	91	87	78
	WFF3-24	1	96	93	83
	WFF3-30	1	101	98	87
	WFF3-36	1	110	106	94
	WFF3-39	1	112	108	97
	WFF3-42	1	114	111	99

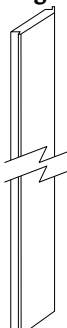
	Model	Carton Quantity	Cherry	Maple	Red Oak
	FA3-30	1	80	77	69
	FA3-42	1	94	91	81
	FA3-60	1	102	99	88

	Model	Carton Quantity	Cherry	Maple	Red Oak
	FFA3-30	1	126	122	109
	FFA3-36	1	136	131	117
	FFA3-39	1	139	134	120
	FFA3-42	1	144	139	124

	Model	Carton Quantity	Cherry	Maple	Red Oak
	WFC3-30	1	87	84	75
	WFC3-42	1	134	129	116

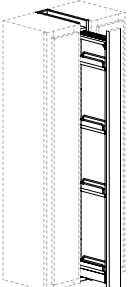
	Model	Carton Quantity	Cherry	Maple	Red Oak
	WFP3-30	1	253	244	218
	WFP6-30	1	296	286	255

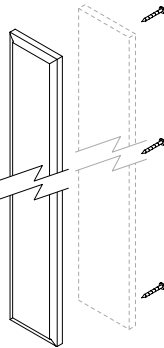
	Model	Carton Quantity	Cherry	Maple	Red Oak
	3" Wide				
	OL3-12	1	31	30	N/A
	OL3-15	1	37	35	N/A
	OL3-18	1	42	40	N/A
	OL3-21	1	47	45	N/A
	OL3-24	1	52	51	N/A
	OL3-27	1	54	53	N/A
	OL3-30	1	57	55	N/A
	OL3-36	1	63	60	N/A
	OL3-39	1	65	63	N/A
	OL3-42	1	68	66	N/A
	6" Wide				
	OL6-21	1	64	62	N/A
	OL6-24	1	75	72	N/A
	OL6-30	1	85	82	N/A
	OL6-36	1	96	92	N/A
	OL6-39	1	101	97	N/A
	OL6-42	1	107	103	N/A

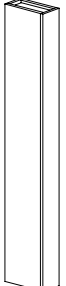
	Model	Carton Quantity	Cherry	Maple	Red Oak
	3" Wide				
	WB3-1230	1	123	119	106
	WB3-1242	1	160	154	138
	6" Wide				
WB6-1230	1	171	165	147	
WB6-1242	1	222	214	191	

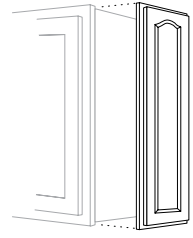

Model	1	2	3	4	5	6	7	8
11 1/4" wide								
MWEP1230	122	125	140	150	160	175	195	205
MWEP1236	128	131	147	157	168	184	205	215
MWEP1239	122	125	140	150	160	175	195	205
MWEP1242	138	141	158	169	181	198	220	232

	Model	1	2	3	4	5	6	7	8
Base Single Door	Specify R or L								
	B12	278	285	319	342	365	399	444	467
	B15	299	306	343	367	392	429	478	502
	B18	321	329	369	395	421	461	513	540
	B21	345	354	396	425	453	495	552	580
	B24	371	380	426	456	487	532	593	624
Base Single Door Full-Height	Specify R or L								
	12" Deep								
	B1212FH	241	247	276	296	316	345	385	405
	B1512FH	259	265	297	318	340	371	414	435
	B1812FH	278	285	319	342	365	399	445	468
	B2112FH	299	307	343	368	392	429	478	503
	B2412FH	322	330	369	395	422	461	514	540
	24" Deep								
	B9FH	235	241	270	289	309	337	376	395
	B12FH	253	259	290	311	332	363	404	425
	B15FH	272	279	312	334	357	390	435	457
	B18FH	292	299	335	359	383	419	467	491
	B21FH	314	322	361	386	412	451	502	528
	B24FH	338	346	388	415	443	485	540	568
	Base Double Door	One Drawer							
B24B		434	445	499	534	570	623	694	730
B27B		456	467	523	561	598	654	729	767
B30B		479	491	550	589	628	687	766	805
B33B		503	515	577	618	660	721	804	845
B36B		528	541	606	649	693	757	844	887
B39		528	541	606	649	693	757	844	887
Two Drawers									
B42		554	568	636	682	727	795	886	932
B45		582	597	668	716	764	835	931	978
B48	611	626	702	752	802	877	977	1027	
Base Double Door Full-Height	12" Deep								
	B2412BFH	377	386	432	463	494	541	602	633
	B2712BFH	396	405	454	487	519	568	632	665
	B3012BFH	416	426	477	511	545	596	664	698
	24" Deep								
	B24BFH	397	407	456	488	521	570	635	667
	B27BFH	417	427	479	513	547	598	667	701
	B30BFH	438	449	503	538	574	628	700	736
	B33BFH	460	471	528	565	603	660	735	773
	B36BFH	483	495	554	594	633	693	772	811
	B39FH	481	492	551	591	630	689	768	807
	B42FH	505	517	579	620	662	724	807	848
	B45FH	530	543	608	651	695	760	847	890
	B48FH	556	570	638	684	730	798	889	935

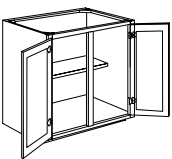
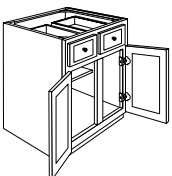
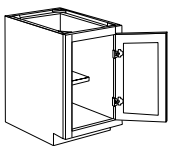
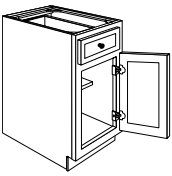

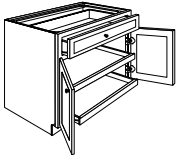
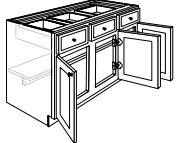
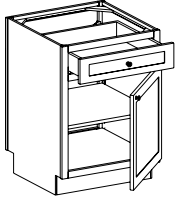
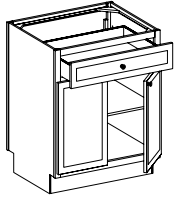
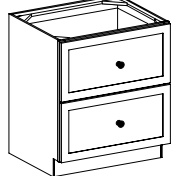
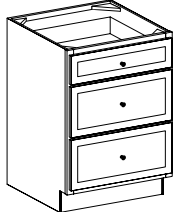
	Model	1	2	3	4	5	6	7	8	
Base Butt Door - Full Extension Tray	BSD30B	450	461	516	553	590	645	719	756	
	BSD36B	496	508	569	610	650	711	793	833	
	Trays pictured are not included in the list price of the cabinet									
Base Three Door	B54	625	640	717	768	819	896	999	1050	
										
Peninsula Base Single Door	PB18	482	494	553	592	632	691	770	810	
	PB21	518	531	594	637	679	743	828	870	
	PB24	557	571	639	685	730	799	890	936	
										
Peninsula Base Butt Door	PB24B	641	657	736	788	841	920	1025	1078	
	PB27B	673	690	773	828	883	966	1076	1132	
	PB30B	742	761	852	913	974	1065	1187	1248	
	PB36B	780	799	895	958	1022	1118	1246	1310	
										
Base Pots and Pans Storage	BPPS27-2D	777	796	891	955	1018	1114	1241	1305	
	BPPS30-2D	835	855	958	1026	1095	1197	1334	1403	
	BPPS33-2D	897	920	1030	1103	1177	1287	1434	1508	
	BPPS36-2D	965	988	1107	1186	1265	1384	1542	1621	
										
Base Three Drawer	3/4 Extension Drawer									
	BD12-3D	390	400	448	480	512	560	624	656	
	BD15-3D	420	430	482	516	550	602	671	705	
	BD18-3D	451	462	518	555	592	647	721	758	
	BD21-3D	485	497	557	596	636	696	775	815	
	BD24-3D	521	534	598	641	684	748	833	876	
	BD27-3D	553	566	634	680	725	793	883	929	
	Full Extension Drawer									
	BD30-3D	619	634	710	761	812	888	989	1040	
	BD33-3D	693	710	796	852	909	994	1108	1165	
	BD36-3D	777	796	891	955	1018	1114	1241	1305	
										

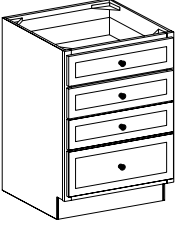
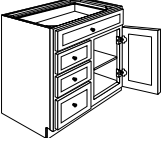
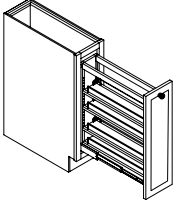
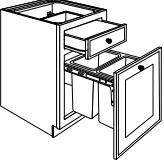
	Model	1	2	3	4	5	6	7	8
Base Four Drawer 	BD12-4D	418	428	480	514	548	600	668	702
	BD15-4D	449	460	516	552	589	645	718	755
	BD18-4D	483	495	554	594	633	693	772	812
	BD21-4D	519	532	596	638	681	745	830	873
	BD24-4D	558	572	641	686	732	801	892	938
	BD27-4D	600	615	689	738	787	861	959	1008
Base Combination Four Drawer 	Specify DR or DL								
	BCD24 DR or DL-4D	535	548	614	657	701	767	855	898
	BCD30 DR or DL-4D	578	593	664	711	758	830	924	972
	BCD36 DR or DL-4D	626	641	718	769	820	897	1000	1051
Base Pull-Out 	BPO9	579	594	665	712	760	831	926	973
Base Wastebasket Top Mount 	BWBT15	629	645	722	773	825	902	1006	1057
	BWBT18	692	709	794	851	908	993	1106	1163

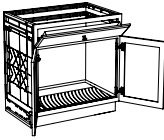
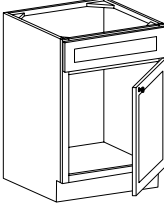
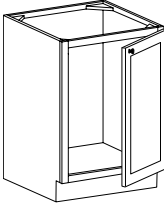
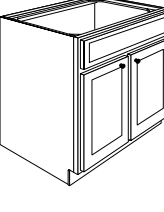
	Model	1	2	3	4	5	6	7	8
CoreGuard® Sink Base 	Without Utility Tray								
	SB30B-CG	628	644	721	772	824	901	1004	1055
	SB33B-CG	641	656	735	788	840	919	1024	1076
	SB36B-CG	653	670	750	803	857	937	1044	1098
	With Utility Tray								
	SB30BUT-CG	667	684	766	820	875	957	1067	1121
	SB33BUT-CG	681	697	781	837	893	976	1088	1144
	SB36BUT-CG	694	711	797	854	910	996	1110	1167
Sink Base Single Door 	Specify R or L Without Utility Tray								
	SB12	244	250	280	300	320	350	390	410
	SB15	262	269	301	322	344	376	419	441
	SB18	282	289	324	347	370	404	451	474
	SB21	303	311	348	373	398	435	485	509
	SB24	326	334	374	401	427	467	521	548
	With Utility Tray								
	SB24UT	352	361	404	433	462	505	563	592
Sink Base Single Door Full-Height 	Specify R or L								
	SB24FH	297	304	340	365	389	425	474	498
Sink Base Double Door 	24" Deep Without Utility Tray								
	SB24B	374	383	429	460	490	536	598	628
	SB27B	393	402	450	483	515	563	627	660
	SB30B	433	443	497	532	568	621	692	727
	SB33B	433	443	497	532	568	621	692	727
	SB36B	454	466	521	559	596	652	726	764
	SB39	454	466	521	559	596	652	726	764
	SB42	477	489	548	587	626	684	763	802
	SB48	526	539	604	647	690	755	841	884
	27" Deep Without Utility Tray								
	SB2727B	410	420	470	503	537	587	655	688
	SB3027B	451	463	518	555	592	648	722	759
	SB3327B	451	463	518	555	592	648	722	759
	SB3627B	474	486	544	583	622	680	758	797
	SB4227	498	510	571	612	653	714	796	836
	24" Deep With Utility Tray								
	SB24BUT	381	390	437	468	500	546	609	640
	SB27BUT	431	441	494	530	565	618	688	724
	SB30BUT	452	463	519	556	593	649	723	760
	SB33BUT	475	487	545	584	623	681	759	798

	Model	1	2	3	4	5	6	7	8
Sink Base Double Door Continued	SB36BUT	499	511	572	613	654	715	797	838
	SB39UT	499	511	572	613	654	715	797	838
	SB42UT	524	536	601	644	687	751	837	880
	SB48UT	577	591	662	710	757	828	923	970
	27" Deep With Utility Tray								
	SB2727BUT	447	458	513	549	586	641	714	750
	SB3027BUT	492	505	565	605	646	706	787	827
	SB3327BUT	492	505	565	605	646	706	787	827
	SB3627BUT	517	530	593	636	678	742	826	869
	SB4227UT	543	556	623	667	712	779	868	912
Sink Base Double Door Full-Height	SB24BFH	342	350	392	420	448	490	546	574
	SB27BFH	359	368	412	441	471	515	574	603
	SB30BFH	396	405	454	486	519	568	632	665
	SB33BFH	396	405	454	486	519	568	632	665
	SB36BFH	415	426	477	511	545	596	664	698
	SB39FH	414	424	475	508	542	593	661	695
	SB42FH	434	445	498	534	569	623	694	730
	SB48FH	479	490	549	589	628	687	765	804
Sink Front Single Door	Specify R or L								
	SF24	235	241	270	289	309	338	376	396
Sink Front Single Door Full-Height	SF24FH	241	247	277	296	316	346	385	405
Sink Front Double Door	SF24B	305	312	350	375	400	437	487	512
	SF30B	343	351	394	422	450	492	548	576
	SF36B	357	365	409	438	468	512	570	599

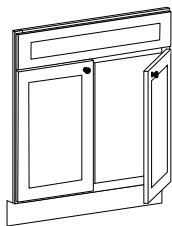
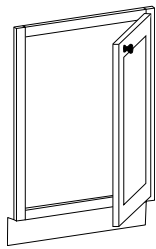
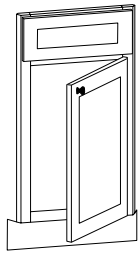
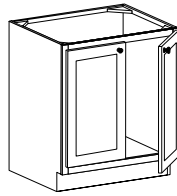
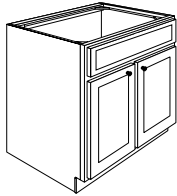

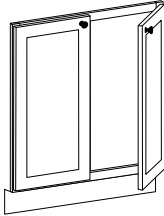
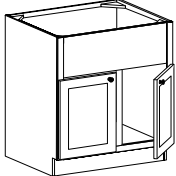
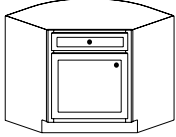
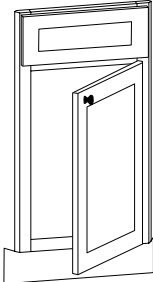
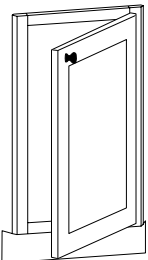
	Model	1	2	3	4	5	6	7	8
Sink Front Double Door Full-Height 	SF24BFH	279	286	320	343	366	400	445	468
	SF30BFH	314	321	360	385	411	450	501	527
	SF36BFH	326	334	374	401	428	468	521	548
Deep Sink Base 	DSB30	522	535	599	642	685	749	834	877
	DSB33	553	567	635	680	726	794	884	930
	DSB36	586	601	673	721	769	841	937	985
Sink Base Angle 	Specify R or L								
	SBA36	280	287	321	344	367	402	448	471
	SBA42	309	316	354	380	405	443	494	519
Sink Front Angle 	Specify R or L								
	SFA36	255	261	292	313	334	365	407	428
	SFA39	267	274	307	329	351	383	427	449
	SFA42	281	288	322	345	368	403	449	472
Sink Front Angle Full-Height 	SFA36FH	243	249	279	299	319	349	389	409

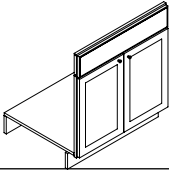
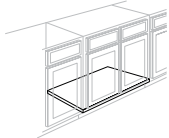
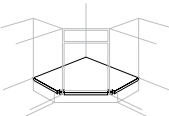
	Model	1	2	3	4	5	6	7	8
Removable Sink Front Double Door 	RSF30B	378	387	433	464	495	542	604	635
	RSF33B	393	402	451	483	515	563	628	660
	RSF36B	408	418	469	502	536	586	653	686
	RSF42	421	431	483	517	552	603	672	707
Sink Front Bottom 	SFB2336	64	64	64	64	64	64	64	64
Sink Front Diagonal Bottom 	SFDB4242	96	96	96	96	96	96	96	96

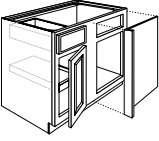
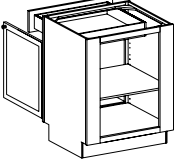
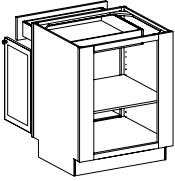
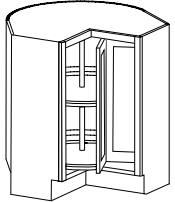
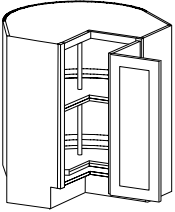
	Model	1	2	3	4	5	6	7	8
Base Blind Corner 	Specify BR or BL								
	BBC36/39 BR or BL	356	365	409	438	467	511	570	599
	BBC39/42 BR or BL	383	393	440	471	503	550	612	644
	BBC42/45 BR or BL	412	422	473	506	540	591	658	692
	BBC45/48 BR or BL	443	454	508	544	581	635	708	744
	BBC48/51 BR or BL	476	488	546	585	624	683	761	800
Peninsula Base Single Door Blind Corner 	Specify R or L								
	PBBC24/27	456	467	523	561	598	654	729	767
Peninsula Base Butt Door Blind Corner 	PBBC24/27B	513	526	589	631	673	737	821	863
Base Lazy Susan 	BLS36	582	597	668	716	N/A	835	N/A	N/A
	Available in traditional overlay door styles only								
Base Corner Revolving 	Specify R or L								
	BCR33	575	589	660	707	754	825	919	966
	BCR36	604	619	693	742	792	866	965	1014

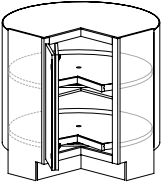
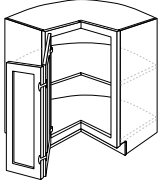
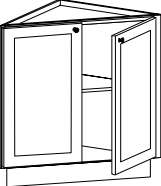
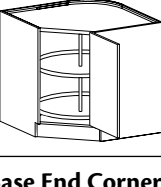
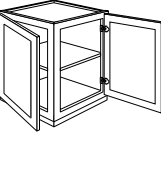
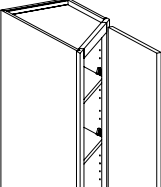
	Model	1	2	3	4	5	6	7	8
Base Corner Revolving Wood Lazy Susan	Specify R or L								
	BCR36WLS	755	774	867	929	991	1083	1207	1269
									
Base Corner Fixed Shelf	Specify R or L								
	BCFS36	468	479	537	575	614	671	748	786
									
Base Corner Angle Butt Full-Height	BCA24BFH	476	488	547	586	625	683	761	800
									
Base Angle Revolving	Specify R or L								
	BAR36	677	694	777	832	888	971	1082	1137
									
Base End Corner Full-Height	BEC24FH	476	488	547	586	625	683	761	800
									
Base End Angle Full-Height	Specify R or L								
	BEA12FH R or L	306	313	351	376	401	438	488	513
									

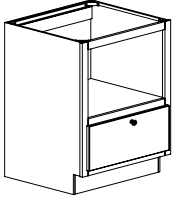
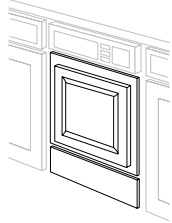
	Model	1	2	3	4	5	6	7	8
Base Microwave Cabinet 	BMC24	522	535	599	642	685	749	834	877
	BMC27	561	575	644	690	736	805	897	943
	BMC30	603	618	692	742	791	865	964	1014
Decorative Dishwasher Panel 	DDWP	219	224	251	269	287	313	349	367

	Model	Carton Quantity	Cherry	Maple	Red Oak
Base Oven Cabinet Universal	BOCU30	1	600	579	517
	BOCU33	1	660	637	569

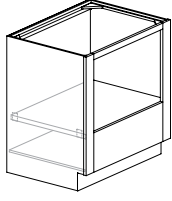

Dishwasher Panel	DWP	1	89	86	77
	DWP-4	4	339	328	293

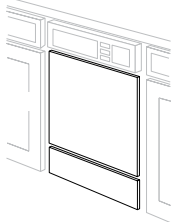

Drop-In Range Panel	DIP30	1	125	121	108
----------------------------	--------------	---	-----	-----	-----



Model	Carton Quantity	Cherry	Maple	Red Oak
-------	-----------------	--------	-------	---------

ITEM	MODEL	Qty	Price	ITEM	MODEL	Qty	Price	ITEM	MODEL	Qty	Price																								
Base Wastebasket Floor Mount Kit Single	BWBFMK	1	99	Drawer Partition Kit	DPK	1	36	Towel Bar	TB	1	35																								
	BWBFMK-6	6	564									Drawer Organizer Kit Narrow	DOKN	1	69	Sliding Towel Bar - Chrome	STB	1	87																
Base Wastebasket Floor Mount Kit Double	BWBFMK-2	1	398	Drawer Organizer Kit Wide	DOKW	1	83	Wire Tray Divider Kit	WTDK16	1	51																								
	Base Wastebasket Top Mount Kit	BWBTK15	1						320	Pegged Deep Drawer Organizer	PDDO30	1	162	WTDK16-5PR	5	242																			
BWBTK18-2		1	365	Foil Box Rack	FBRK18	1	57	Wire Tray Divider Roll-Out	WTDRO9		1	230																							
Base Swing-Out Shelves	BSOS42	1	319						Spice Drawer Insert Kit	SDIK15	1	170	Utility Tray Kit	UTK12	1	52																			
	BSOS42-3	3	909	Knife Section Cutting Center Kit	SDIK18	1	217	UTK12-20PR						20	988																				
	BSOS45	1	341					Cutlery Divider						SDIK21	1	175	UTK22	1	52																
	BSOS45-3	3	973														Cupboard Organizer	SDIK24	1	179	UTK22-20	20	988												
Base Cabinet	BC18	1	179						Cupboard Organizer	CO18	1	179	Cupboard Organizer								CO18	1	179												
				Base Cabinet	BC24	1	249																	Cupboard Organizer	CO24	1	249	Cupboard Organizer	CO24	1	249				
								Base Cabinet						BC30	1	319																Cupboard Organizer	CO30	1	319
																	Base Cabinet	BC36	1	389															

	Model	Carton Quantity	Cherry	Maple	Red Oak
Base Filler	BF3	1	49	47	42
	BF6	1	70	68	60

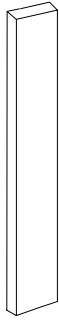

	Model	Carton Quantity	Cherry	Maple	Red Oak
Fluted Filler Angle	FFA3-30	1	126	122	109



	Model	Carton Quantity	Cherry	Maple	Red Oak
Base Fluted Filler	BFF3	1	106	102	91

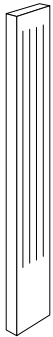

	Model	Carton Quantity	Cherry	Maple	Red Oak
Base Filler Corner	BFC3	1	92	88	79

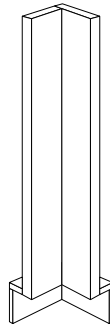

	Model	Carton Quantity	Cherry	Maple	Red Oak
Filler Angle	FA3-30	1	80	77	69

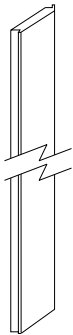

	Model	Carton Quantity	Cherry	Maple	Red Oak
Base Filler Pull-Out	BFP3	1	314	304	271
	BFP6	1	415	401	358

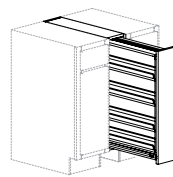

	Model	Carton Quantity	Cherry	Maple	Red Oak
Filler Overlay	OL3-30	1	57	55	N/A
	OL6-30	1	85	82	N/A

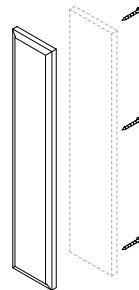

	Model	Carton Quantity	Cherry	Maple	Red Oak
Base Box	BB3-2434	1	370	357	319
	BB6-2434	1	518	500	447

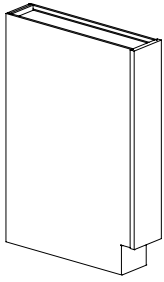

Base End Panel Filler

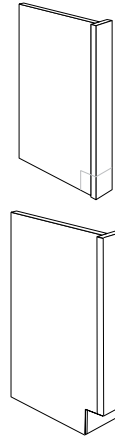

	Model	Carton Quantity	Cherry	Maple	Red Oak
Base End Panel Filler	BEPF3-34	1	115	111	99
	BEPF3-34-2	2	218	211	188
	BEPF6-34	1	232	224	200
	Specify R or L				
	BEPF3-34	1	115	111	99

Base Column	15" Deep				
	BC3-1534	1	401	388	346
BC6-1534	1	562	543	484	
	27" Deep				
	BC3-2734	1	574	554	495
	BC6-2734	1	799	771	689

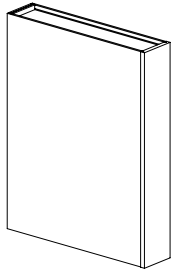

Base Column Fluted	15" Deep				
	BCF6-1534	1	413	399	356
	27" Deep				
	BCF6-2734	1	586	566	505

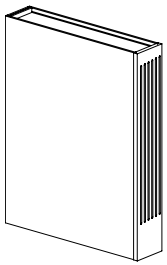

Base End Panel	BEP	1	94	91	81
	BEP-6	6	536	517	462

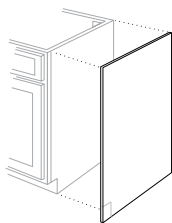

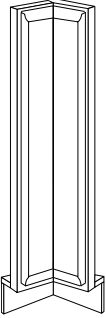
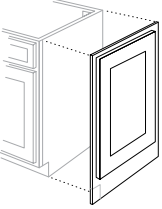
Model	1	2	3	4	5	6	7	8	
Base Filler Corner Overlay  BFOLC3 Available for all full overlay door styles only	N/A	N/A	N/A	130	139	152	170	178	
Matching Base End Panel 	MBEP2434	209	214	240	257	274	300	334	351

Tall Utility Cabinet 12" Deep

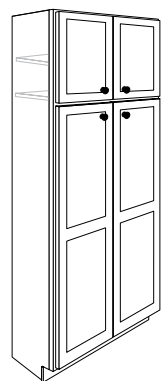
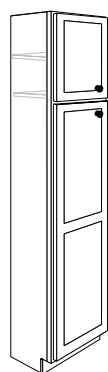

Model	1	2	3	4	5	6	7	8
Specify R or L 84" High								
U1584	528	541	606	650	693	758	844	888
U1884	581	595	667	714	762	834	929	977
U2484	703	721	807	865	922	1009	1124	1182
U2484B	683	700	784	840	896	980	1092	1148
U3084B	782	801	897	961	1025	1121	1250	1314
U3684B	895	917	1027	1101	1174	1284	1431	1504
90" High								
U1590	551	564	632	677	722	790	880	925
U1890	606	621	695	745	794	869	968	1018
U2490	733	751	841	901	961	1051	1171	1231
U2490B	710	727	815	873	931	1018	1135	1193
U3090B	813	833	933	999	1066	1166	1299	1365
U3690B	930	953	1068	1144	1220	1335	1487	1563
93" High								
U1593	561	575	644	690	736	805	897	943
U1893	617	633	708	759	810	885	987	1037
U2493	747	765	857	918	980	1071	1194	1255
U2493B	784	804	900	964	1029	1125	1254	1318
U3093B	830	850	952	1020	1088	1190	1326	1394
U3693B	950	973	1090	1168	1246	1362	1518	1596
96" High								
U1596	572	586	656	703	750	820	914	961
U1896	629	644	722	773	825	902	1005	1057
U2496	761	780	873	936	998	1092	1217	1279
U2496B	739	758	849	909	970	1061	1182	1242
U3096B	847	867	971	1041	1110	1214	1353	1423
U3696B	969	993	1112	1192	1271	1390	1549	1629

Tall Utility Cabinet 24" Deep

Model	1	2	3	4	5	6	7	8
Specify R or L								
84" High								
U158424	608	623	698	747	797	872	972	1021
U188424	669	685	767	822	877	959	1069	1124
U248424	809	829	928	995	1061	1161	1293	1360
U248424B	785	804	901	965	1029	1126	1254	1319
U308424B	899	921	1031	1105	1178	1289	1436	1510
U368424B	1029	1054	1181	1265	1349	1476	1644	1729
90" High								
U159024	632	648	726	777	829	907	1011	1062
U189024	696	713	798	855	912	998	1112	1169
U249024	842	862	966	1035	1104	1207	1345	1414
U249024B	816	836	937	1004	1071	1171	1305	1372
U309024B	935	958	1073	1149	1226	1341	1494	1570
U369024B	1070	1096	1228	1316	1403	1535	1710	1798
93" High								
U159324	644	660	739	792	845	924	1029	1082
U189324	708	726	813	871	929	1016	1132	1190
U249324	857	878	984	1054	1124	1229	1370	1440
U249324B	900	922	1033	1106	1180	1291	1438	1512
U309324B	954	977	1094	1173	1251	1368	1524	1603
U369324B	1092	1119	1253	1342	1432	1566	1745	1835
96" High								
U159624	657	673	754	807	861	942	1050	1103
U189624	722	740	829	888	947	1036	1155	1214
U249624	874	896	1003	1075	1146	1254	1397	1469
U249624B	850	871	975	1045	1114	1219	1358	1428
U309624B	973	997	1116	1196	1276	1395	1555	1635
U369624B	1114	1141	1278	1369	1461	1598	1780	1872

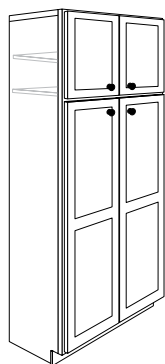
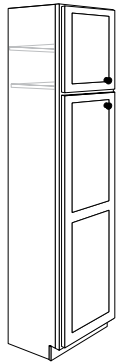

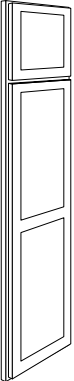
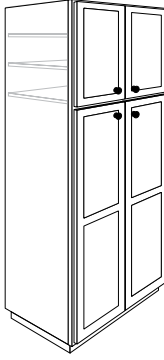
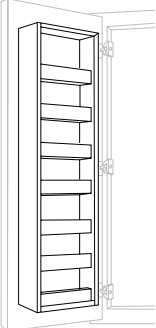
	Model	1	2	3	4	5	6	7	8
Utility Front 	Specify R or L 84" High								
	UF1584	449	460	515	552	589	644	717	754
	UF1884	471	483	541	579	618	676	753	792
	UF2484	519	532	596	639	681	745	830	873
	UF2484B	545	559	626	671	715	782	872	917
	90" High								
	UF1590	469	480	538	577	615	673	749	788
	UF1890	492	504	565	605	646	706	787	827
	UF2490	543	556	623	667	712	779	868	912
	UF2490B	570	584	654	701	747	818	911	958
	93" High								
	UF1593	478	490	549	588	627	686	765	804
	UF1893	502	515	576	618	659	721	803	844
	UF2493	554	568	636	681	726	794	885	931
	UF2493B	582	596	667	715	763	834	930	977
	96" High								
	UF1596	487	499	559	599	639	698	778	818
	UF1896	511	524	587	629	671	733	817	859
	UF2496	564	578	647	693	739	809	901	947
	UF2496B	592	606	679	728	776	849	946	995
Pantry Cabinet Butt Door 	PC3684B	1214	1244	1393	1492	1592	1741	1940	2039
	PC3690B	1264	1295	1450	1553	1657	1812	2020	2123
	PC3693B	1288	1320	1478	1583	1689	1847	2059	2164
	PC3696B	1312	1345	1506	1613	1721	1882	2098	2205
Door Pantry Rack 	DPR18	329	329	329	329	329	329	329	329

Swing-Out
Pantry Rack

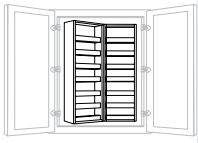

Model	1	2	3	4	5	6	7	8
SPR	533	533	533	533	533	533	533	533

Oven Cabinet Universal

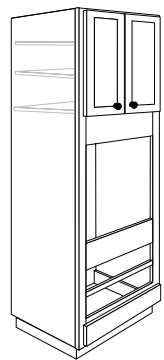

Model	1	2	3	4	5	6	7	8
84" High								
OCU2784B	790	810	907	971	1036	1133	1263	1328
OCU3084B	905	927	1038	1112	1186	1298	1446	1520
OCU3384B	905	927	1038	1112	1186	1298	1446	1520
90" High								
OCU2790B	859	880	986	1056	1126	1232	1373	1443
OCU3090B	983	1008	1128	1209	1290	1410	1572	1652
OCU3390B	983	1008	1128	1209	1290	1410	1572	1652
93" High								
OCU2793B	893	915	1025	1098	1172	1281	1428	1501
OCU3093B	956	979	1097	1175	1254	1371	1528	1606
OCU3393B	1023	1048	1174	1257	1341	1467	1635	1719
96" High								
OCU2796B	928	950	1064	1140	1216	1330	1483	1559
OCU3096B	1062	1088	1219	1306	1393	1523	1697	1784
OCU3396B	1062	1088	1219	1306	1393	1523	1697	1784

Oven Cabinet Single

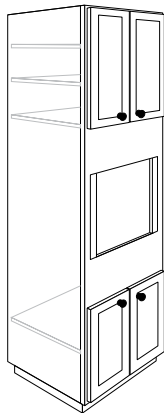

84" High								
OCS2784B	808	827	927	993	1059	1158	1291	1357
OCS3084B	1013	1038	1163	1245	1329	1453	1619	1702
OCS3384B	1013	1038	1163	1245	1329	1453	1619	1702
90" High								
OCS2790B	900	922	1033	1107	1180	1291	1439	1512
OCS3090B	1129	1157	1296	1388	1481	1620	1805	1897
OCS3390B	1129	1157	1296	1388	1481	1620	1805	1897
93" High								
OCS2793B	952	975	1092	1170	1248	1365	1522	1600
OCS3093B	1066	1092	1223	1311	1398	1529	1704	1792
OCS3393B	1194	1224	1370	1468	1566	1713	1909	2006
96" High								
OCS2796B	1005	1029	1153	1235	1317	1441	1606	1688
OCS3096B	1260	1291	1446	1549	1653	1807	2014	2117
OCS3396B	1260	1291	1446	1549	1653	1807	2014	2117

Oven Drawer Kit

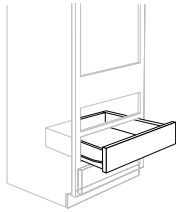

ODK27	138	141	158	170	181	198	220	232
ODK30	145	148	166	178	190	208	231	243
ODK33	150	154	173	185	197	216	240	253

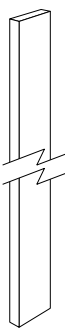
	Model	Carton Quantity	Cherry	Maple	Red Oak
Tall Filler 	TF3-84	1	101	97	87
	TF3-90	1	113	109	97
	TF3-93	1	117	113	101
	TF3-96	1	121	117	104

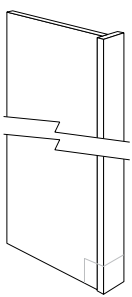
	Model	Carton Quantity	Cherry	Maple	Red Oak
Tall End Panel Filler 	TEPF1-84	1	273	263	235
	TEPF1-96	1	330	318	284

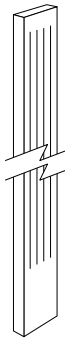
	Model	Carton Quantity	Cherry	Maple	Red Oak
Tall Fluted Filler 	TFF3-84	1	208	201	179
	TFF3-90	1	223	215	192
	TFF3-93	1	230	222	198
	TFF3-96	1	237	229	204

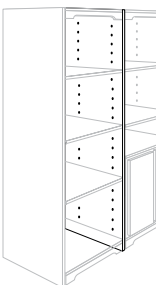
	Model	Carton Quantity	Cherry	Maple	Red Oak
Furniture End Panels 	Not Center Drilled				
	FEP1353	1	227	220	196
	FEP1384	1	300	290	259
	FEP2153	1	274	264	236
	FEP2184	1	348	336	300
	Center Drilled				
FEP1353CE	1	289	279	249	
FEP1384CE	1	312	301	269	

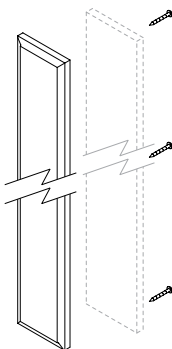
	Model	Carton Quantity	Cherry	Maple	Red Oak
Filler Overlay 	OL3-84	1	103	100	N/A
	OL3-90	1	109	105	N/A
	OL3-93	1	111	107	N/A
	OL3-96	1	114	110	N/A

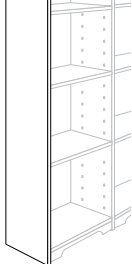
	Model	Carton Quantity	Cherry	Maple	Red Oak
	TEP84	1	248	240	214
	TEP84-2	2	472	455	407
	TEP96	1	271	261	233
	TEP96-2	2	514	496	443
	TEP108	1	293	283	253
	TEP108-2	2	557	537	480

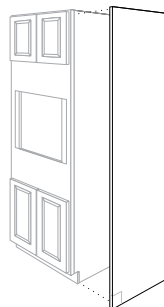
	Model	Carton Quantity	Cherry	Maple	Red Oak
Tall End Panel 	TEP84	1	248	240	214
	TEP84-2	2	472	455	407
	TEP96	1	271	261	233
	TEP96-2	2	514	496	443
	TEP108	1	293	283	253
	TEP108-2	2	557	537	480

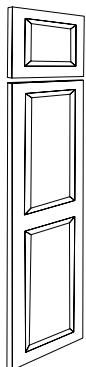
Matching Tall
End Panel

Model	1	2	3	4	5	6	7	8
84" High								
MTEP1284	319	327	366	393	419	458	510	537
MTEP2184	341	349	391	419	447	488	544	572
MTEP2484	361	370	414	443	473	517	577	606
90" High								
MTEP1290	332	340	381	408	436	476	531	558
MTEP2190	354	363	406	435	464	508	566	595
MTEP2490	375	384	430	461	492	538	600	630
93" High								
MTEP1293	319	327	366	393	419	458	510	537
MTEP2193	341	349	391	419	447	488	544	572
MTEP2493	361	370	414	443	473	517	577	606
96" High								
MTEP1296	345	353	396	424	452	495	551	579
MTEP2196	368	377	422	452	482	528	588	618
MTEP2496	390	399	447	479	511	559	623	655

**Vanity Base
Single Door**

Model	1	2	3	4	5	6	7	8
Specify R or L 18" Deep 31 1/2" High								
VB1218	282	289	324	347	370	405	451	474
VB1518	302	309	346	371	396	433	483	507
VB1818	323	331	371	397	424	463	516	543
VB2118	346	354	397	425	453	496	553	581
VB2418	370	379	424	455	485	531	591	622
18" Deep 34 1/2" High								
VB123518	325	333	372	399	426	465	519	545
VB153518	347	356	398	427	455	498	555	583
VB183518	372	381	426	457	487	533	594	624
VB213518	398	407	456	489	521	570	635	668
VB243518	425	436	488	523	558	610	680	715
Specify R or L 21" Deep 31 1/2" High								
VB12	282	289	324	347	370	405	451	474
VB15	302	309	346	371	396	433	483	507
VB18	323	331	371	397	424	463	516	543
VB21	346	354	397	425	453	496	553	581
VB24	370	379	424	455	485	531	591	622
21" Deep 34 1/2" High								
VB1235	325	333	372	399	426	465	519	545
VB1535	347	356	398	427	455	498	555	583
VB1835	372	381	426	457	487	533	594	624
VB2135	398	407	456	489	521	570	635	668
VB2435	425	436	488	523	558	610	680	715



**Vanity Base
Double Door**

18" Deep 31 1/2" High								
VB2418B	384	393	441	472	504	551	614	645
18" Deep 34 1/2" High								
VB243518B	442	453	507	543	579	633	706	742
21" Deep 31 1/2" High								
VB24B	384	393	441	472	504	551	614	645
21" Deep 34 1/2" High								
VB2435B	442	453	507	543	579	633	706	742

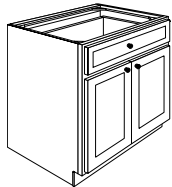

**Vanity Base
Single Door Full-
Height**

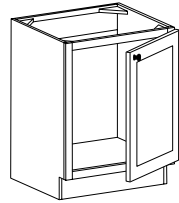
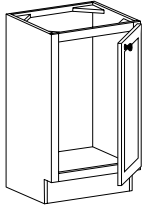

Model	1	2	3	4	5	6	7	8
Specify R or L 16" Deep 31 1/2" High								
VB1816FH	294	301	337	361	386	422	470	494
18" Deep 31 1/2" High								
VB1818FH	294	301	337	361	386	422	470	494
VB2118FH	315	322	361	387	413	451	503	529
VB2418SFH	337	345	386	414	441	483	538	566
18" Deep 34 1/2" High								
VB183518FH	342	351	393	421	449	491	547	575
VB213518FH	366	375	421	451	481	526	586	616
VB243518SFH	365	374	419	449	479	524	584	614
Specify R or L 21" Deep 31 1/2" High								
VB18FH	294	301	337	361	386	422	470	494
VB21FH	315	322	361	387	413	451	503	529
VB24SFH	337	345	386	414	441	483	538	566
21" Deep 34 1/2" High								
VB1835FH	342	351	393	421	449	491	547	575
VB2135FH	366	375	421	451	481	526	586	616
VB2435SFH	392	402	450	482	514	562	627	659
18" Deep 31 1/2" High								
VB2418FH	318	325	364	390	416	455	508	534
VB2418BFH	333	342	383	410	437	478	533	560
VB2718BFH	350	359	402	430	459	502	560	588
VB3018BFH	368	377	422	452	482	527	588	618
VB3318BFH	386	395	443	475	506	554	617	649
VB3618BFH	405	415	465	498	531	581	648	681
VB3918FH	405	415	465	498	531	581	648	681
VB4218FH	426	436	488	523	558	610	680	715
18" Deep 34 1/2" High								
VB243518BFH	381	390	437	468	500	547	609	640
VB273518BFH	400	410	459	492	525	574	640	672
VB303518BFH	420	430	482	517	551	603	671	706
VB333518BFH	441	452	506	542	579	633	705	741
VB363518BFH	463	475	532	569	607	664	740	778
VB393518FH	466	478	535	573	611	669	745	783
VB423518FH	489	501	562	602	642	702	782	822
21" Deep 31 1/2" High								
VB24FH	318	325	364	390	416	455	508	534
VB24BFH	349	358	401	430	458	501	559	587
VB27BFH	350	359	402	430	459	502	560	588
VB30BFH	368	377	422	452	482	527	588	618
VB33BFH	386	395	443	475	506	554	617	649

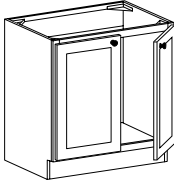
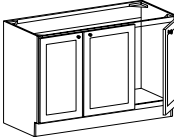
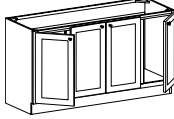
	Model	1	2	3	4	5	6	7	8
Vanity Base Double Door Full-Height Continued 	VB36BFH	405	415	465	498	531	581	648	681
	VB39FH	405	415	465	498	531	581	648	681
	VB42FH	426	436	488	523	558	610	680	715
	21" Deep 34 1/2" High								
	VB2435BFH	381	390	437	468	500	547	609	640
	VB2735BFH	400	410	459	492	525	574	640	672
	VB3035BFH	420	430	482	517	551	603	671	706
	VB3335BFH	441	452	506	542	579	633	705	741
	VB3635BFH	463	475	532	569	607	664	740	778
	VB3935FH	466	478	535	573	611	669	745	783
VB4235FH	489	501	562	602	642	702	782	822	
Vanity Base Three Door Full-Height 	18" Deep 31 1/2" High								
	VB4818FH	469	481	538	577	615	673	750	788
	VB5418FH	517	530	594	636	678	742	827	869
	18" Deep 34 1/2" High								
	VB483518FH	540	553	619	663	708	774	862	907
	VB543518FH	595	609	683	731	780	853	951	999
	21" Deep 31 1/2" Deep								
	VB48FH	469	481	538	577	615	673	750	788
	VB54FH	517	530	594	636	678	742	827	869
	21" Deep 34 1/2" High								
VB4835FH	540	553	619	663	708	774	862	907	
VB5435FH	595	609	683	731	780	853	951	999	
Vanity Base Four Door Full-Height 	18" Deep 31 1/2" High								
	VB6018FH	570	584	654	701	748	818	911	958
	18" Deep 34 1/2" High								
	VB603518FH	656	672	753	806	860	941	1048	1102
	21" Deep 31 1/2" High								
	VB60FH	570	584	654	701	748	818	911	958
	21" Deep 34 1/2" High								
VB6035FH	656	672	753	806	860	941	1048	1102	

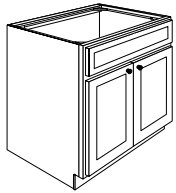

Model	1	2	3	4	5	6	7	8
Vanity Sink Base Butt Door								
18" Deep 31 1/2" High								
VSB2418B	260	266	298	320	341	373	415	437
VSB2718B	283	290	325	348	372	406	453	476
VSB3018B	309	316	354	380	405	443	494	519
VSB3318B	337	345	386	414	441	483	538	566
VSB3618B	367	376	421	451	481	526	586	616
VSB3918	371	380	426	457	487	533	593	624
VSB4218	382	392	439	470	502	549	611	643
18" Deep 34 1/2" High								
VSB243518B	299	306	343	367	392	429	478	502
VSB273518B	326	334	374	401	427	467	521	547
VSB303518B	355	364	408	437	466	509	568	597
VSB333518B	387	397	444	476	508	555	619	650
VSB363518B	422	432	484	519	553	605	674	709
VSB393518	427	438	490	525	560	612	683	717
VSB423518	440	451	505	541	577	631	703	739
21" Deep 31 1/2" High								
VSB24B	260	266	298	320	341	373	415	437
VSB27B	283	290	325	348	372	406	453	476
VSB30B	309	316	354	380	405	443	494	519
VSB33B	337	345	386	414	441	483	538	566
VSB36B	367	376	421	451	481	526	586	616
VSB39	371	380	426	457	487	533	593	624
VSB42	382	392	439	470	502	549	611	643
21" Deep 34 1/2" High								
VSB2435B	299	306	343	367	392	429	478	502
VSB2735B	326	334	374	401	427	467	521	547
VSB3035B	355	364	408	437	466	509	568	597
VSB3335B	387	397	444	476	508	555	619	650
VSB3635B	422	432	484	519	553	605	674	709
VSB3935	427	438	490	525	560	612	683	717
VSB4235	440	451	505	541	577	631	703	739
Vanity Sink Base Double Bowl								
18" Deep 31 1/2" High								
VSB5418-3D	724	741	830	890	949	1038	1156	1216
VSB6018-3D	768	786	881	944	1007	1101	1227	1290
18" Deep 34 1/2" High								
VSB543518-4D	782	801	897	961	1025	1121	1250	1314
VSB603518-4D	829	850	952	1020	1088	1190	1326	1394
21" Deep 31 1/2" High								
VSB54-3D	724	741	830	890	949	1038	1156	1216
VSB60-3D	768	786	881	944	1007	1101	1227	1290

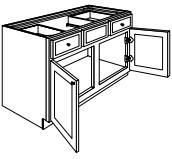
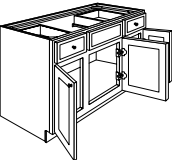
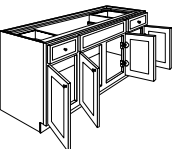

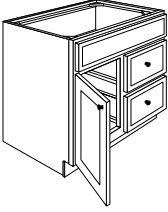
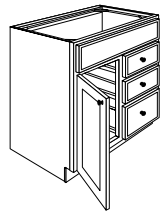
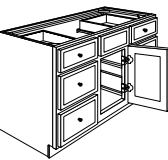
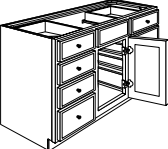
	Model	1	2	3	4	5	6	7	8
Vanity Sink Base Double Bowl Continued	21" Deep 34 1/2" High								
	VSBS435-4D	782	801	897	961	1025	1121	1250	1314
	VSBS6035-4D	829	850	952	1020	1088	1190	1326	1394
Vanity Sink Base Two Drawer Double Door 	18" Deep 31 1/2" High								
	VSBS3618-2D	485	497	556	596	636	695	775	815
	18" Deep 34 1/2" High								
	VSBS363518-2D	558	571	640	685	731	800	891	937
	21" Deep 31 1/2" High								
	VSBS36-2D	485	497	556	596	636	695	775	815
	21" Deep 34 1/2" High								
	VSBS3635-2D	558	571	640	685	731	800	891	937
Vanity Sink Base Two Drawer Three Door 	18" Deep 31 1/2" High								
	VSBS4218-2D	529	542	608	651	694	759	846	890
	VSBS4818-2D	578	592	663	711	758	829	924	971
	VSBS5418-2D	631	647	725	776	828	906	1009	1061
	18" Deep 34 1/2" High								
	VSBS423518-2D	609	624	699	749	798	873	973	1023
	VSBS483518-2D	665	681	763	817	872	954	1063	1117
	VSBS543518-2D	726	744	833	893	952	1041	1161	1220
	21" Deep 31 1/2" High								
	VSBS42-2D	529	542	608	651	694	759	846	890
	VSBS48-2D	578	592	663	711	758	829	924	971
	VSBS54-2D	631	647	725	776	828	906	1009	1061
	21" Deep 34 1/2" High								
	VSBS4235-2D	609	624	699	749	798	873	973	1023
	VSBS4835-2D	665	681	763	817	872	954	1063	1117
	VSBS5435-2D	726	744	833	893	952	1041	1161	1220
Vanity Sink Base Two Drawer Four Door 	18" Deep 31 1/2" High								
	VSBS6018-2D	689	706	791	848	904	989	1102	1159
	18" Deep 34 1/2" High								
	VSBS603518-2D	793	812	910	975	1040	1137	1267	1332
	21" Deep 31 1/2" High								
VSBS60-2D	689	706	791	848	904	989	1102	1159	

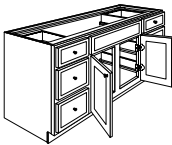
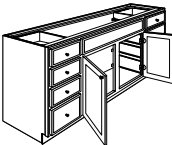
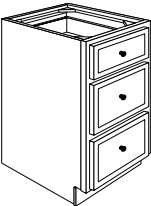
	Model	1	2	3	4	5	6	7	8	
Vanity Sink Base Two Drawer Four Door Continued	21" Deep 34 1/2" High									
	VSB6035-2D	793	812	910	975	1040	1137	1267	1332	
Vanity Combination Drawer Two Drawer 	Specify DR or DL 18" Deep 31 1/2" High									
	VCD2418 DR or DL	456	467	523	561	598	654	729	767	
	VCD3018 DR or DL	508	520	583	624	666	728	812	853	
	VCD3618 DR or DL	565	579	649	695	741	811	903	950	
	21" Deep 31 1/2" High									
	VCD24 DR or DL	456	467	523	561	598	654	729	767	
	VCD30 DR or DL	508	520	583	624	666	728	812	853	
	VCD36 DR or DL	565	579	649	695	741	811	903	950	
	Vanity Combination Drawer Three Drawer 	Specify DR or DL 18" Deep 34 1/2" High								
		VCD243518 DR or DL	525	538	602	645	688	752	839	881
VCD303518 DR or DL		584	598	670	718	766	838	933	981	
VCD363518 DR or DL		650	666	746	799	852	932	1039	1092	
Specify DR or DL 21" Deep 34 1/2" High										
VCD2435 DR or DL		525	538	602	645	688	752	839	881	
VCD3035 DR or DL		584	598	670	718	766	838	933	981	
VCD3635 DR or DL		650	666	746	799	852	932	1039	1092	
Vanity Combination Drawer Six Drawer Single Door 		18" Deep 31 1/2" High								
		VCD4218	629	644	722	773	825	902	1005	1057
	VCD4818	700	717	803	861	918	1004	1119	1176	
	21" Deep 31 1/2" High									
	VCD42	629	644	722	773	825	902	1005	1057	
	VCD48	700	717	803	861	918	1004	1119	1176	
	Vanity Combination Drawer Eight Drawer Single Door 	18" Deep 34 1/2" High								
		VCD423518	723	741	830	889	949	1038	1156	1215
VCD483518		805	825	924	990	1056	1155	1287	1353	
VCD603518		997	1022	1145	1226	1308	1431	1594	1676	
21" Deep 34 1/2" High										
VCD4235		723	741	830	889	949	1038	1156	1215	
VCD4835		805	825	924	990	1056	1155	1287	1353	

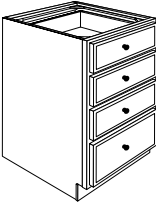
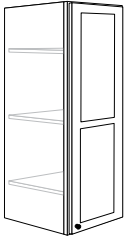
	Model	1	2	3	4	5	6	7	8
Vanity Combination Drawer Six Drawer Double Door 	18" Deep 31 1/2" High								
	VCD6018	867	889	995	1066	1137	1244	1386	1457
	21" Deep 31 1/2" High								
	VCD60	867	889	995	1066	1137	1244	1386	1457
Vanity Combination Drawer Eight Drawer Double Door 	21" Deep 34 1/2" high								
	VCD6035	997	1022	1145	1226	1308	1431	1594	1676
Vanity Drawer Three Drawer 	18" Deep 31 1/2" High								
	VD1218-3D	352	361	404	433	462	505	563	592
	VD1518-3D	379	388	434	466	497	543	605	636
	VD1818-3D	407	417	467	500	534	584	651	684
	VD2118-3D	438	448	502	538	574	628	699	735
	VD2418-3D	470	482	540	578	617	675	752	790
	18" Deep 34 1/2" High								
	VD123518-3D	405	415	465	498	531	581	647	681
	VD153518-3D	435	446	500	535	571	625	696	732
	VD183518-3D	468	480	537	575	614	671	748	787
	VD213518-3D	503	516	577	619	660	722	804	846
	VD243518-3D	541	554	621	665	709	776	865	909
	21" Deep 31 1/2" High								
	VD12-3D	352	361	404	433	462	505	563	592
	VD15-3D	379	388	434	466	497	543	605	636
	VD18-3D	407	417	467	500	534	584	651	684
	VD21-3D	438	448	502	538	574	628	699	735
	VD24-3D	470	482	540	578	617	675	752	790
	21" Deep 34 1/2" High								
	VD1235-3D	405	415	465	498	531	581	647	681
	VD1535-3D	435	446	500	535	571	625	696	732
	VD1835-3D	468	480	537	575	614	671	748	787
	VD2135-3D	503	516	577	619	660	722	804	846
	VD2435-3D	541	554	621	665	709	776	865	909

	Model	1	2	3	4	5	6	7	8
Vanity Drawer Four Drawer 	18" Deep 34 1/2" High								
	VD123518-4D	396	405	454	487	519	568	632	665
	VD153518-4D	425	436	488	523	558	610	680	715
	VD183518-4D	457	469	525	562	600	656	731	768
	VD213518-4D	492	504	564	604	645	705	786	826
	VD243518-4D	528	541	606	650	693	758	845	888
	21" Deep 34 1/2" High								
	VD1235-4D	396	405	454	487	519	568	632	665
	VD1535-4D	425	436	488	523	558	610	680	715
	VD1835-4D	457	469	525	562	600	656	731	768
	VD2135-4D	492	504	564	604	645	705	786	826
	VD2435-4D	528	541	606	650	693	758	845	888
	Vanity Linen Cabinet 	Specify R or L							
VLC1848		381	390	437	468	499	546	609	640
Vanity Linen Cabinet Tall 	Specify R or L 18" Deep 84" Tall								
	VLC158418	562	576	645	691	737	807	899	945
	VLC188418	590	605	677	726	774	847	944	992
	VLC248418	651	667	747	800	854	934	1040	1094
	VLC248418B	683	700	784	840	896	980	1092	1148
	18" Deep 90" Tall								
	VLC159018	585	599	671	719	767	838	934	982
	VLC189018	614	629	704	755	805	880	981	1031
	VLC249018	677	693	777	832	887	971	1082	1137
	VLC249018B	711	728	815	874	932	1019	1136	1194
	18" Deep 96" Tall								
	VLC159618	608	623	698	747	797	872	972	1021
	VLC189618	638	654	732	785	837	916	1020	1073
	VLC249618	704	721	808	865	923	1009	1125	1182
	VLC249618B	739	757	848	908	969	1060	1181	1242
	Specify R or L 21" Deep 84" Tall								
	VLC1584	562	576	645	691	737	807	899	945
	VLC1884	590	605	677	726	774	847	944	992
	VLC2484	651	667	747	800	854	934	1040	1094
	VLC2484B	683	700	784	840	896	980	1092	1148

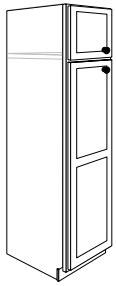
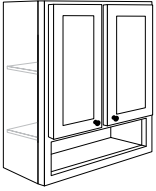
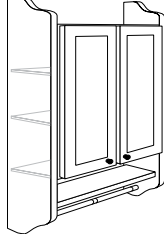
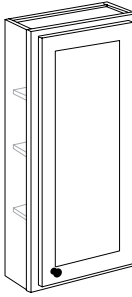
	Model	1	2	3	4	5	6	7	8
Vanity Linen Cabinet Tall Continued 	21" Deep 90" Tall								
	VLC1590	585	599	671	719	767	838	934	982
	VLC1890	614	629	704	755	805	880	981	1031
	VLC2490	677	693	777	832	887	971	1082	1137
	VLC2490B	711	728	815	874	932	1019	1136	1194
	21" Deep 96" Tall								
	VLC1596	608	623	698	747	797	872	972	1021
	VLC1896	638	654	732	785	837	916	1020	1073
	VLC2496	704	721	808	865	923	1009	1125	1182
	VLC2496B	739	757	848	908	969	1060	1181	1242
Vanity Wall Boutique - 7" Deep 	VWB2430	300	308	345	369	394	431	480	504
	VWB2430B	315	323	362	388	413	452	504	530
Vanity Wall Boutique - 8" Deep 	VWB2648	585	599	671	719	767	838	934	982
Vanity Wall - 4 3/4" Deep 	Specify R or L								
	VW1530	220	225	252	270	288	315	351	369

	Model	Carton Quantity	Cherry	Maple	Red Oak
Medicine Cabinet	MC1627	1	299	289	258

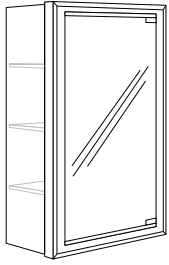

Tri-View	TVMC2430	1	442	427	381
Medicine Cabinet	TVMC3030	1	511	493	440
	TVMC3630	1	590	570	509

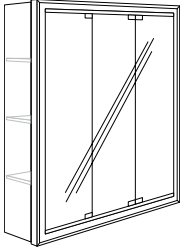

Model	Carton Quantity	Cherry	Maple	Red Oak
-------	-----------------	--------	-------	---------

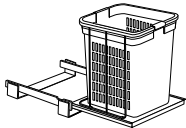
	Model	Carton Quantity	Cherry	Maple	Red Oak
Vanity Hamper Roll-Out 	VHRO18	1	249	249	249

	Model	Carton Quantity	Cherry	Maple	Red Oak
Vanity Filler 	VF3	1	49	47	42

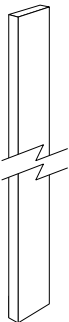
	Model	Carton Quantity	Cherry	Maple	Red Oak
Tall Filler 	TF3-84	1	101	97	87
	TF3-90	1	113	109	97
	TF3-93	1	117	113	101
	TF3-96	1	121	117	104

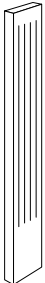
	Model	Carton Quantity	Cherry	Maple	Red Oak
Vanity Fluted Filler 	VFF3	1	106	102	91

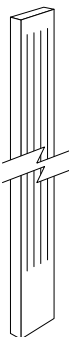
	Model	Carton Quantity	Cherry	Maple	Red Oak
Tall Fluted Filler 	TFF3-84	1	208	201	179
	TFF3-90	1	223	215	192
	TFF3-93	1	230	222	198
	TFF3-96	1	237	229	204

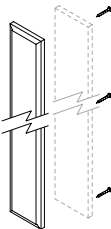
	Model	Carton Quantity	Cherry	Maple	Red Oak
Filler Overlay 	OL3-27	1	54	53	N/A
	OL3-30	1	57	55	N/A

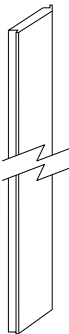
	Model	Carton Quantity	Cherry	Maple	Red Oak
Filler Angle 	FA3-30	1	80	77	69
	FA3-42	1	94	91	81
	FA3-60	1	102	99	88

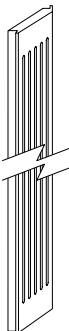
	Model	Carton Quantity	Cherry	Maple	Red Oak
Fluted Filler Angle 	FFA3-30	1	126	122	109
	FFA3-36	1	136	131	117
	FFA3-39	1	139	134	120
	FFA3-42	1	144	139	124

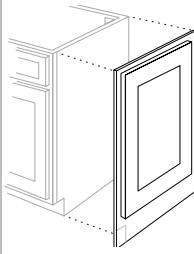
	Model	1	2	3	4	5	6	7	8
Matching Vanity End Panel 	MVEP2131	188	192	215	231	246	269	300	316
	MVEP2135	205	210	235	252	268	294	327	344

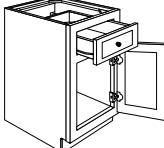
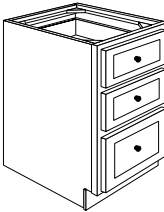
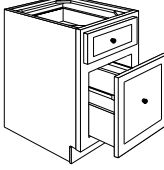
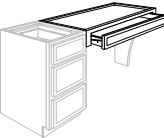
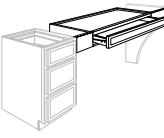
	Model	1	2	3	4	5	6	7	8
Desk Door 	Specify R or L								
	DDO15	298	305	342	367	391	428	476	501
	DDO18	320	328	368	394	420	460	512	538
	DDO21	345	353	395	424	452	494	551	579
	DDO24	370	379	425	455	486	531	592	622
Desk Drawer 	DDR12	352	361	404	433	462	505	563	592
	DDR15	379	388	434	466	497	543	605	636
	DDR18	407	417	467	500	534	584	651	684
	DDR21	438	448	502	538	574	628	699	735
	DDR24	470	482	540	578	617	675	752	790
Desk File Drawer 	DFD15	401	411	460	493	526	575	641	674
	DFD18	425	436	488	523	557	610	679	714
	DFD21	451	462	517	554	591	646	720	757
	DFD24	478	489	548	587	626	685	763	803
Desk Knee Drawer 	18" deep								
	DKD2418	233	239	268	287	306	335	373	392
	DKD3018	262	269	301	322	344	376	419	441
	DKD3618	295	302	338	362	386	423	471	495
	21" deep								
	DKD24	233	239	268	287	306	335	373	392
	DKD30	262	269	301	322	344	376	419	441
DKD36	295	302	338	362	386	423	471	495	
Desk Knee Drawer Trimmable 	18" deep								
	DKDT2418	280	287	321	344	367	402	448	471
	DKDT3018	315	322	361	387	413	451	503	529
	DKDT3618	354	362	406	435	464	507	565	594
	21" deep								
	DKDT24	280	287	321	344	367	402	448	471
	DKDT30	315	322	361	387	413	451	503	529
DKDT36	354	362	406	435	464	507	565	594	

**Matching Desk
End Panel**

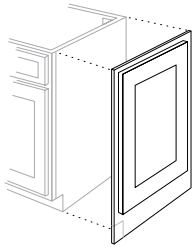

Model	1	2	3	4	5	6	7	8
MDEP	188	192	215	231	246	269	300	316

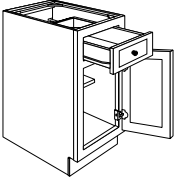
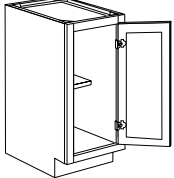
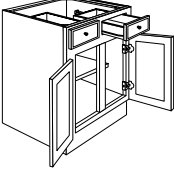
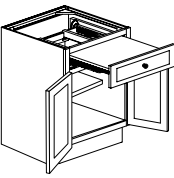
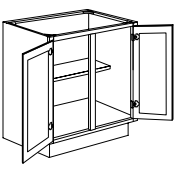
	Model	1	2	3	4	5	6	7	8
Universal Base Single Door 	Specify R or L								
	UB12	278	285	319	342	365	399	444	467
	UB15	299	306	343	367	392	429	478	502
	UB18	321	329	369	395	421	461	513	540
	UB21	345	354	396	425	453	495	552	580
	UB24	371	380	426	456	487	532	593	624
Universal Base Single Door - Full-Height 	Specify R or L								
	UB9FH	235	241	270	289	309	337	376	395
	UB12FH	253	259	290	311	332	363	404	425
	UB15FH	272	279	312	334	357	390	435	457
	UB18FH	292	299	335	359	383	419	467	491
	UB24FH	338	346	388	415	443	485	540	568
Universal Base Double Door 	UB24B	434	445	499	534	570	623	694	730
	UB27B	456	467	523	561	598	654	729	767
	UB30B	479	491	550	589	628	687	766	805
	UB33B	503	515	577	618	660	721	804	845
	UB36B	528	541	606	649	693	757	844	887
	UB42	554	568	636	682	727	795	886	932
Universal Base Table Butt Door 	UBT24B	792	812	909	974	1039	1137	1267	1332
Universal Base Double Door - Full-Height 	UB24BFH	377	386	432	463	494	540	602	633
	UB27BFH	395	405	454	486	518	567	632	664
	UB30BFH	415	425	476	510	544	595	664	698
	UB33BFH	436	447	500	536	572	625	697	732
	UB36BFH	458	469	525	563	600	656	732	769
	UB39FH	481	492	551	591	630	689	768	807
	UB42FH	505	517	579	620	662	724	807	848
	UB45FH	530	543	608	651	695	760	847	890
	UB48FH	556	570	638	684	730	798	889	935

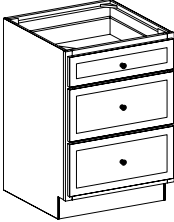
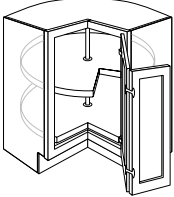
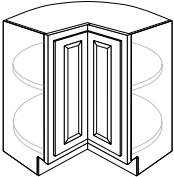
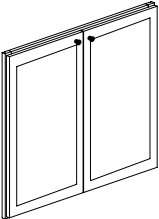
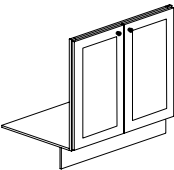
	Model	1	2	3	4	5	6	7	8
Universal Base Three Drawer 	UBD12-3D	390	400	448	480	512	560	624	656
	UBD15-3D	420	430	482	516	550	602	671	705
	UBD18-3D	451	462	518	555	592	647	721	758
	UBD21-3D	485	497	557	596	636	696	775	815
	UBD24-3D	521	534	598	641	684	748	833	876
Universal Base Corner Revolving 	Specify R or L								
	UBCR36	604	619	693	742	792	866	965	1014
Universal Base Lazy Susan 	UBLS36	582	597	668	716	N/A	835	N/A	N/A
	Available in traditional overlay door styles only								
Universal Base Sink Front Butt Door - Full- Height 	UBSF36BFH	309	317	355	380	405	443	494	519
Universal Base Sink Front Cabinet Kit - Full- Height 	USFCK30BFH	285	292	327	351	374	409	456	480
	USFCK33BFH	300	307	344	368	393	430	479	503
	USFCK36BFH	315	322	361	387	413	451	503	529
	USFCK42FH	347	355	398	426	455	498	554	583

**Universal
Removable Sink
Front Double
Doors**

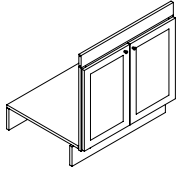

Model	1	2	3	4	5	6	7	8
URSF30B	378	387	433	464	495	542	604	635
URSF33B	393	402	451	483	515	563	628	660
URSF36B	408	418	469	502	536	586	653	686
URSF42	421	431	483	517	552	603	672	707

ITEM	MODEL	Qty	Price	ITEM	MODEL	Qty	Price	ITEM	MODEL	Qty	Price
Universal Base Toekick Cover - Laminate	TKCUL8	1	20								
	TKCUL8-4	4	76								
Universal Base Toekick Cover - Veneer	TKCUV8	1	29								
	TKCUV8-4	4	110								

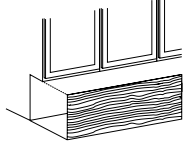
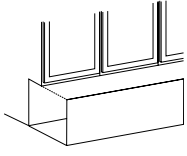

	Model	Carton Quantity	Cherry	Maple	Red Oak
Panel Backer-Paper	PB4896P	1	118	118	118
	PB4896P-2	2	224	224	224

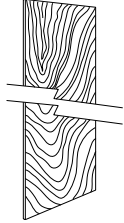

	Model	Carton Quantity	Cherry	Maple	Red Oak
Panel Backer 3' Tall-Veneer	PB4834	1	226	218	195
	PB4834-4	4	860	830	741

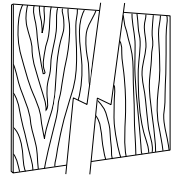

	Model	Carton Quantity	Cherry	Maple	Red Oak
Panel Backer-Veneer	4' x 8'				
	PB4896	1	408	394	352
	PB4896-2	2	776	749	669
	8' x 4'				
	PB9648	1	509	492	439
	PB9648-2	2	968	934	834

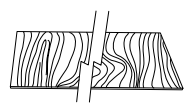
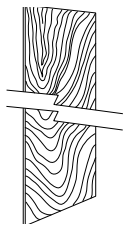

	Model	Carton Quantity	Cherry	Maple	Red Oak
Universal Access Panel	UAP30	1	240	232	207
	UAP33	1	247	238	213
	UAP36	1	254	245	219
	UAP42	1	260	251	224
V-Groove Panel	VGP4834	1	276	267	238
	VGP4896	1	632	610	545

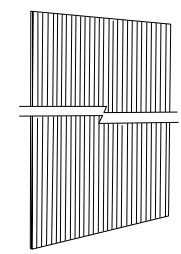
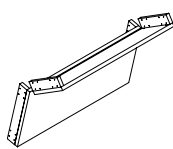

	Model	Carton Quantity	Cherry	Maple	Red Oak
Panel Backer 3' Tall-Paper	PB4834P	1	N/A	63	N/A
	PB4834P-4	4	N/A	239	N/A

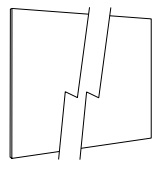

	Model	Carton Quantity	Cherry	Maple	Red Oak
CoreGuard® Panel Backer	CGPB36	1	78	78	78

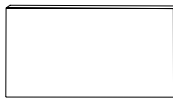

ITEM	MODEL	Qty	Price	ITEM	MODEL	Qty	Price	ITEM	MODEL	Qty	Price	
Shelf Kits	3/4" Thick											
	PCSK3612-3/4	1	85									
	USK1512-3/4	1	81									
	USK1812-3/4	1	85									
	USK2412-3/4	1	94									
	USK3012-3/4	1	103									
	USK3612-3/4	1	114									
	USK1524-3/4	1	150									
	USK1824-3/4	1	155									
	USK2424-3/4	1	165									
	USK3024-3/4	1	177									
	USK3624-3/4	1	189									
	VLSK1521-3/4	1	150									
	VLSK1821-3/4	1	155									
	VLSK2421-3/4	1	162									
		5/8" Thick										
		PCSK3612-5/8	1	85								
		USK1512-5/8	1	81								
		USK1812-5/8	1	70								
		USK2412-5/8	1	79								
		USK3012-5/8	1	103								
		USK3612-5/8	1	114								
		USK1524-5/8	1	150								
		USK1824-5/8	1	141								
		USK2424-5/8	1	152								
	USK3024-5/8	1	177									
	USK3624-5/8	1	189									
	VLSK1521-5/8	1	150									
	VLSK1821-5/8	1	140									
	VLSK2421-5/8	1	157									

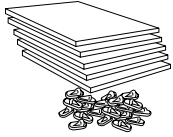

	Model	Carton Quantity	Cherry	Maple	Red Oak
Furniture Shelf Kit	13" Deep				
	FS3013	1	112	108	97
	FS3613	1	129	125	112
	FS1384	1	283	273	244
	21" Deep				
	FS3021	1	133	128	115
	FS3621	1	155	150	134
FS2184	1	340	328	293	



**Toeboard/
Valance**



	Model	Carton Quantity	Cherry	Maple	Red Oak
Toeboard/ Valance	TBV30	1	113	109	97
	TBV36	1	116	112	100

Heavy Duty Furniture Shelf Kit	HDFS3013	1	151	146	130
	HDFS3613	1	158	152	136

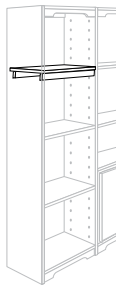

Shelf Top and Bottom	13" Deep				
	STB3013	1	136	131	117
	STB3613	1	159	153	137
	21" Deep				
	STB3021	1	180	174	155
	STB3621	1	195	188	168

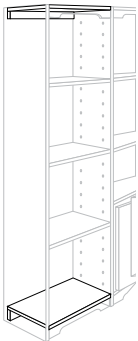

	Model	Carton Quantity	Cherry	Maple	Red Oak
Angled Outside Corner Molding - 135°	AOSC8	1	56	54	48
	AOSC8-25	25	1322	1277	1140

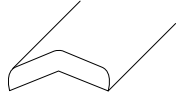

Chair Rail Molding	CR8	1	66	64	57
	CR8-15	15	942	910	812

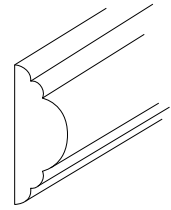

Corner Molding	Inside Corner Molding Solid Wood				
	ICM8	1	49	47	42
	ICM8-25	25	1157	1117	998
	Inside Corner Molding Paper Wrapped				
	ICPM8	1	N/A	N/A	14
	ICPM8-20	20	N/A	N/A	266
	Outside Corner Molding Solid Wood				
	OSC8	1	51	49	44
	OSC8-25	25	1212	1170	1045
	Outside Corner Molding Paper Wrapped				
OSCP8	1	N/A	N/A	16	
OSCP8-20	20	N/A	N/A	304	

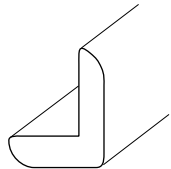
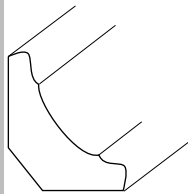

	Model	Carton Quantity	Cherry	Maple	Red Oak
Countertop Molding - Decorative Edge	CTD8	1	70	67	60
	CTD8-16	16	1058	1021	912

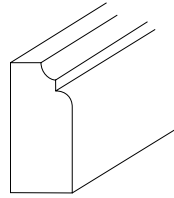

Cove Large Molding	CVLM8		155	150	134
	CVLM8-4		591	570	509

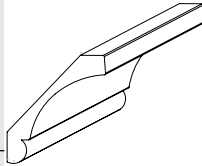

Angle Crown Molding	Finished				
	ACM8	1	119	115	103
	ACM8-6	6	681	658	587
	Unfinished				
	ACM8-UF	1	119	115	103
	ACM8-6-UF	6	681	658	587

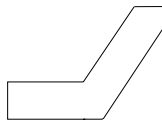

Classic Crown Molding	8' length				
	CCM8	1	222	215	192
	10' length				
	CCM-SW10	1	187	180	161

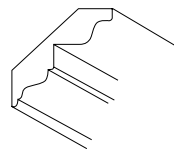

Crown Molding	8' length				
	CM8	1	111	108	96
	CM8-15	15	1587	1532	1368
	10' length				
	CM-SW10	1	133	128	114
CM-SW10-15	15	1888	1823	1628	

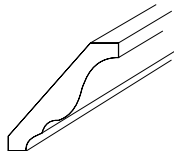

Soffit Crown Molding	8' length				
	SCM8	1	87	84	75
	10' length				
SCM-SW10	1	103	100	89	

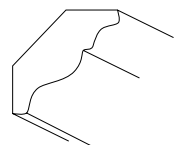

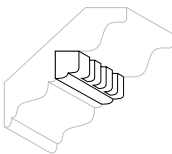
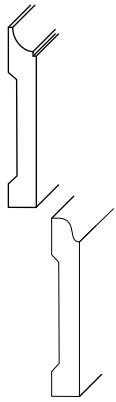
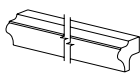
	Model	Carton Quantity	Cherry	Maple	Red Oak
Dentil Molding 	DM8	1	115	111	99
Furniture Base 	Contemporary Furniture Base				
	CFB8	1	147	142	127
	Traditional Furniture Base				
	TFB8	1	147	142	127
Inset Light Rail 	CVLR8		70	67	60
	CVLR8-6		397	383	342

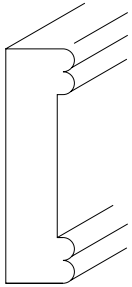
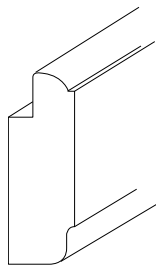
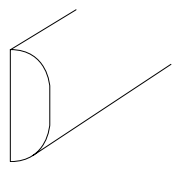
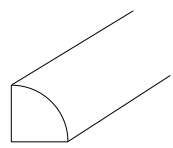
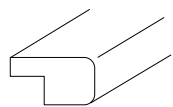
	Model	Carton Quantity	Cherry	Maple	Red Oak
Library Molding 	LM8	1	129	124	111
	LM8-10	10	1223	1181	1055
Mirror Molding 	MM8	1	94	91	81
	MM8-2	2	179	172	154
Narrow Batten Molding 	NBM8	1	35	34	30
	NBM8-25	25	827	798	713
Quarter Round Molding 	QR8	1	38	37	33
	QR8-28	28	1018	983	878
Radius Cabinet Molding 	RCM8	1	201	194	173
	RCM8-6	6	1144	1104	986

	Model	Carton Quantity	Cherry	Maple	Red Oak
Rope Molding	RM8	1	87	87	87



Scribe Molding	Scribe Molding Solid Wood				
	SM8	1	30	29	26
	SM8-63	63	1805	1743	1556
	Paper Wrapped				
	SPM8	1	N/A	N/A	10
	SPM8-100	100	N/A	N/A	950
	Wide Scribe Molding				
	WSM8	1	45	44	39
	WSM8-25	25	1074	1037	926

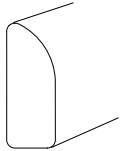
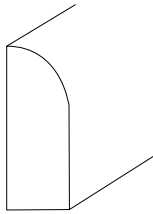

Scribe Cove Molding					
	SCV8	1	43	41	37
	SCV8-25	25	1019	984	879

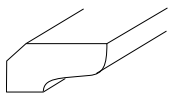

	Model	Carton Quantity	Cherry	Maple	Red Oak
Shoe Molding	SHO8	1	38	37	33
	SHO8-25	25	908	878	784

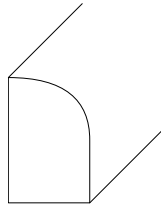

Single Bead Pilaster					
	SBP8	1	171	165	147

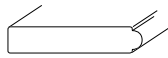

Single Bead Trim					
	SBT8	1	79	76	68

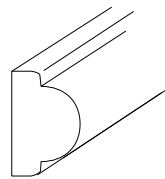

Solid Wood Stock					
	SWS4	1	81	78	70
	SWS6	1	121	117	104
	SWS8	1	196	189	169

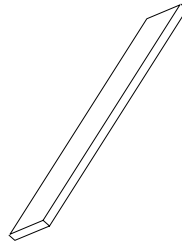

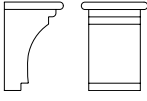

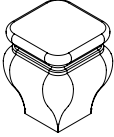
	Model	Carton Quantity	Cherry	Maple	Red Oak
Cove Corbel 	Finished				
	CVC69		252	243	N/A
	CVC312		284	274	N/A
	Unfinished				
	CVC69-UF		252	243	N/A
	CVC312-UF		284	274	N/A

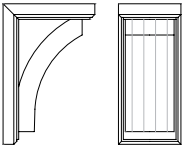
	Model	Carton Quantity	Cherry	Maple	Red Oak
Cove Foot 	Finished				
	CVFT		202	195	N/A
	Unfinished				
	CVFT-UF		202	195	N/A

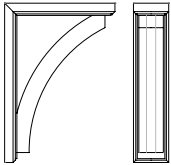

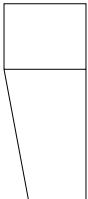
	Model	Carton Quantity	Cherry	Maple	Red Oak
Wincott Corbel Small 	Finished				
	WNC49		354	342	N/A
	Unfinished				
	WNC49-UF		354	342	N/A









	Model	Carton Quantity	Cherry	Maple	Red Oak
Wincott Corbel Large 	Finished				
	WNC313		406	392	N/A
	Unfinished				
	WNC313-UF		406	392	N/A

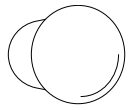
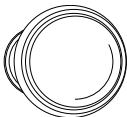
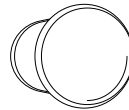
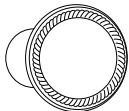
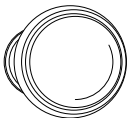
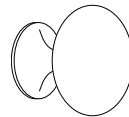
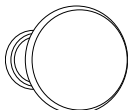

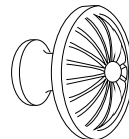
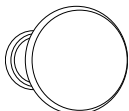
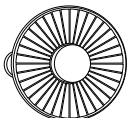
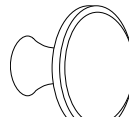
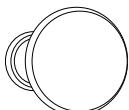
	Model	Carton Quantity	Cherry	Maple	Red Oak
Tapered Foot 	Finished				
	PFT	1	166	160	143
	Unfinished				
	PFT-UF	1	166	160	143

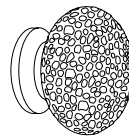
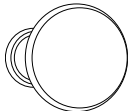

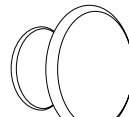
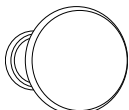







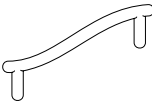

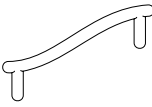
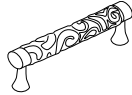
	Model	Carton Quantity	Cherry	Maple	Red Oak
Tapered Leg Base 	Finished				
	PLB	1	428	413	369
	Unfinished				
	PLB-UF	1	428	413	369

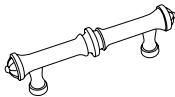
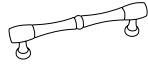

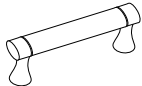
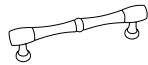
	Model	Carton Quantity	Cherry	Maple	Red Oak
Plain Square Post 	PSP6-30	1	437	422	377
	PSP6-34	1	490	473	422
	PSP6-36	1	494	477	426
	PSP6-42	1	608	587	524

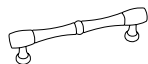
	Model	Carton Quantity	Cherry	Maple	Red Oak
Spindles 	Spindle Finished				
	SP5-36	1	585	564	504
	SP5-42	1	649	627	559
	Spindle Unfinished				
	SP5-36-UF	1	N/A	564	N/A
	SP5-42-UF	1	N/A	627	N/A
Roman Spindle Finished					
	RSP5-36	1	601	580	518
Roman Spindle Unfinished					
	RSP5-36-UF	1	N/A	580	N/A

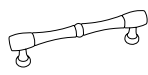
ITEM	MODEL	Qty	Price	ITEM	MODEL	Qty	Price	ITEM	MODEL	Qty	Price
White Ceramic Knob	HK02	1	4	Antique Iron Knob	HK119	1	4	Satin Nickel Knob	HK137	1	4
											
Satin Nickel Rope Knob	HK107	1	5	Satin Nickel Knob	HK120	1	4	Satin Nickel Football Shaped Knob	HK138	1	5
											
Solid Bright Brass Knob	HK108	1	6	Antique Pewter Braided Knob	HK123	1	4	Brushed Satin Pewter French Tassel Round Knob	HK150	1	5
											
Satin Nickel Knob	HK109	1	5	Copper-Pewter Knob	HK125	1	4	Black Ceramic Insert Round Knob	HK152	1	4
											
Black Nickel Knob	HK110	1	5	Rusty Flower Knob	HK126	1	4	Tumbled Dark Gunmetal Round Knob	HK155	1	7
											
Bright Chrome Knob	HK111	1	5	Dusty Copper Flower Knob	HK127	1	4	Oil Rubbed Bronze Round Knob	HK157	1	4
											
Satin Aluminum Knob	HK117	1	6	Antique Pewter Flower Knob	HK128	1	4				
											

ITEM	MODEL	Qty	Price	ITEM	MODEL	Qty	Price	ITEM	MODEL	Qty	Price
Satin Nickel Diminishing Knob	HK158	1	2								
											
Ochre Finished Ceramic Totem Knob	HK161	1	5								
											
Venetian Bronze Copper French Lace Knob	HK162	1	5								
											

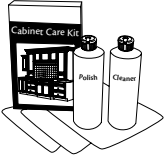
ITEM	MODEL	Qty	Price	ITEM	MODEL	Qty	Price	ITEM	MODEL	Qty	Price
Satin Nickel Suitcase Pull 	HP103	1	5	Satin Nickel Fusilli Pull 	HP139	1	4	Satin Nickel Wavy Pull 	HP159	1	9
Satin Nickel Rope Pull 	HP106	1	5	White Fusilli Pull 	HP140	1	4	Ochre Finished Ceramic Totem Pull 	HP160	1	7
Satin Aluminum Boat Cleat Transitional Pull 	HP112	1	10	Brushed Satin Pewter French Tassel Pull 	HP151	1	7	Chrome Traditional Pull 	HP163	1	8
Satin Nickel Traditional Pull 	HP118	1	3	Black Ceramic Insert Pull 	HP153	1	6	Satin Nickel Traditional Pull 	HP164	1	8
Antique Pewter Braided Pull 	HP124	1	7	Tumbled Dark Gunmetal Mission Style Ringed Pendant Pull 	HP154	1	4	Bright Brass Traditional Pull 	HP165	1	8
Satin Nickel Wire Cable Pull 	HP131	1	6	Oil Rubbed Bronze Cup Pull 	HP156	1	6	Black Nickel Traditional Pull 	HP166	1	8
Satin Nickel Canoe Pull 	HP135	1	6								

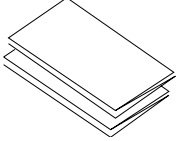
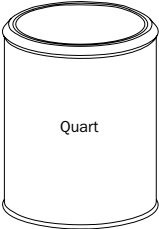
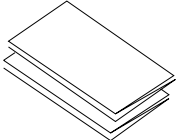
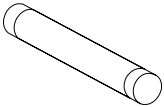
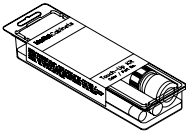
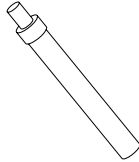
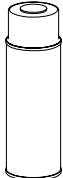

ITEM	MODEL	Qty	Price	ITEM	MODEL	Qty	Price	ITEM	MODEL	Qty	Price
Cabinet Care Kit 	CCK	1	54	Touch Up Spray Can Topcoat 	TSCT	1	33				
					TSCT-12	12	376				
Cabinet Cleaning and Polishing Cloths 	CCPC	25	84	Touch Up Quart 	QST	1	69				
					QP	1	69				
Cabinet Dusting Cloths 	CDC	6	54		QGL	1	69				
					QCST	1	69				
Fill Stick 	FS	1	17								
	FS-12	12	194								
Touch Up Kit 	TUK	1	70								
Touch Up Pen 	TP	1	33								
	TP-12	12	376								
Touch Up Spray Can Primer 	TSCP	1	33								
	TSCP-12	12	376								

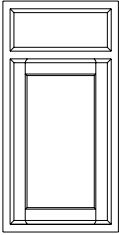
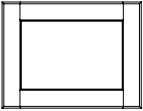
Replacement Parts

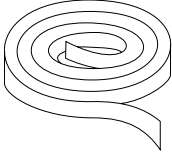
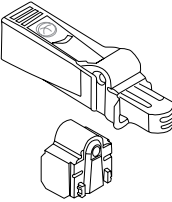
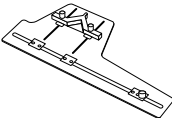
	Model	1	2	3	4	5	6	7	8
Door and Frame Assembly Sales Samples 	ACCESSDFAVB12	105	108	121	129	138	151	168	176
Sales Door 	SLDO14.75X11.25	64	65	73	78	83	91	102	107

ITEM	MODEL	Qty	Price	ITEM	MODEL	Qty	Price	ITEM	MODEL	Qty	Price
Edge Banding	EB	1	38								
											
SoftAction™ Door Hardware	SADO	1	14								
											
Hardware Template Kit Universal	HTK-U	1	124								
											

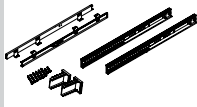
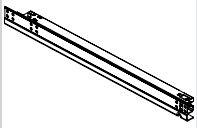
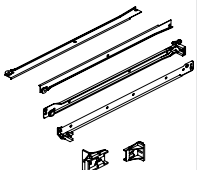
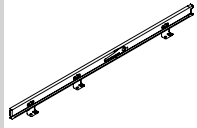
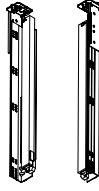
Replacement Parts

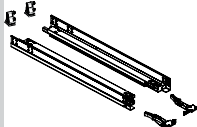
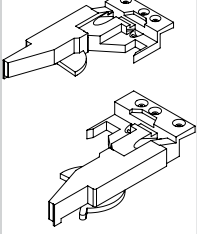
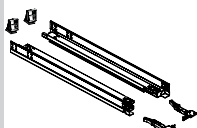
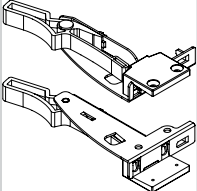

ITEM	MODEL	Qty	Price	ITEM	MODEL	Qty	Price	ITEM	MODEL	Qty	Price		
3/4 Extension Side Mount Roller Guide Kit 	GDESM18KIT	1	84	Full Extension Side Mount Ball Bearing Guide Kit 	GDEFESMBB21KIT	1	84	Full Extension Under Mount Soft Action+™ Guides 	GDEUMFESAL18	1	46		
	GDESM21KIT	1	84		GDEFESMBB24KIT	1	84		GDEUMFESAL21	1	46		
	GDESM24KIT	1	84						GDEUMFESAL24	1	46		
							GDEUMFESAR18		1	46			
							GDEUMFESAR21		1	46			
							GDEUMFESAR24		1	46			
3/4 Extension Side Mount Roller Guide Peninsula Base Kit 	GDESMPB24KIT	1	84	Full Extension Side Mount Ball Bearing Guides 	GDEFESMBBIL21	1	21	Full Extension Heavy Duty Under Mount Soft Action+™ Guide Set 	GDEUMFESAHD24SET	1	87		
					GDEFESMBBIL21-10	10	200						
					GDEFESMBBIL24	1	25						
					GDEFESMBBIL24-10	10	238						
					GDEFESMBBIR21	1	21						
					GDEFESMBBIR21-10	10	200						
					GDEFESMBBIR24	1	25						
					GDEFESMBBIR24-10	10	238						
					GDEFESMBBO21	1	21						
					GDEFESMBBO21-10	10	200						
			GDEFESMBBO24	1	25								
			GDEFESMBBO24-10	10	238								
3/4 Extension Side Mount Roller Guides 	GDESMIL18	1	6	Full Extension Under Mount SoftAction™ Guide Kit 	GDEUMFESA18KIT	1	84	Locking Device - Full Extension Heavy Duty Under Mount Soft Action+™ Guides 	LKDUMFESAGDEHDL	1	18		
	GDESMIL18-10	10	57			GDEUMFESA21KIT	1		84	LKDUMFESAGDEHDR	1	18	
	GDESMIL21	1	6			GDEUMFESA24KIT	1		84				
	GDESMIL21-10	10	57										
	GDESMIL24	1	8		Full Extension Under Mount Soft Action+™ Peninsula Base Guide Kit 	GDEFESAPB24KIT	1	46	Locking Device - Full Extension Under Mount Soft Action+™ Guides 	LKDUMFESAGDEL	1	18	
	GDESMIL24-10	10	76								LKDUMFESAGDER	1	18
	GDESMIR18	1	6										
	GDESMIR18-10	10	57										
	GDESMIR21	1	6										
	GDESMIR21-10	10	57										
	GDESMIR24	1	8										
	GDESMIR24-10	10	76										
	GDESMOL18	1	6										
	GDESMOL18-10	10	57										
	GDESMOL21	1	6										
	GDESMOL21-10	10	57										
	GDESMOL24	1	8										
	GDESMOL24-10	10	76										
GDESMOR18	1	6											
GDESMOR18-10	10	57											
GDESMOR21	1	6											
GDESMOR21-10	10	57											
GDESMOR24	1	8											
GDESMOR24-10	10	76											

ITEM	MODEL	Qty	Price	ITEM	MODEL	Qty	Price	ITEM	MODEL	Qty	Price
Rear Mounting Bracket - 3/4 Extension Side Mount Roller Guides	RMBSMGDE	1	2	Rear Mounting Bracket - Full Extension Under Mount Soft Action+™ Guides DKD	RMBUMFESAGDEKDSET	1	5	Bi-Fold Hinge	HINBIFOLD-1CT	1	14
	RMBSMGDE-25	25	19						HINBIFOLD-10CT	10	133
Rear Mounting Bracket - 3/4 Extension Side Mount Roller Guides Peninsula Base	RMBSMGDEPB	1	2	Rear Mounting Bracket - Full Extension Side Mount Ball Bearing Guides	RMBFESMBBGDE	1	8	Face Mount Hinge	HINFM-1PR	1	25
	RMBSMGDEPB-2	2	4						HINFM-10PR	10	238
Rear Mounting Bracket - Full Extension Under Mount Soft Action+™ Guides	RMBUMFESAGDE-2	2	21	Rear Adjustment Adapter - Full Extension Heavy Duty Under Mount Soft Action+™ Guides	RAAUMFESAGDEHDSET	1	21	Full Overlay 4 Way Hinge	HINFOL4WY-1PR	1	10
									HINFOL4WY-10PR	10	95
Rear Mounting Bracket - Full Extension Under Mount Soft Action+™ Guides Peninsula Base	RMBUMFESAGDEPB-2	2	15	170 Degree Hinge	HIN170FRM-1CT	1	14	Full Overlay 6 Way Hinge	HINFOL6WY-1PR	1	21
					HIN170FRM-10CT	10	133		HINFOL6WY-10PR	10	200

Replacement Parts

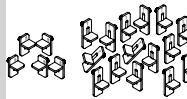
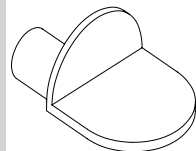
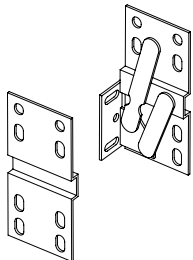
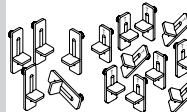
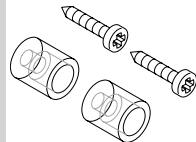
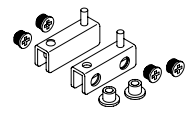
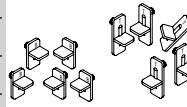
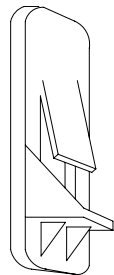
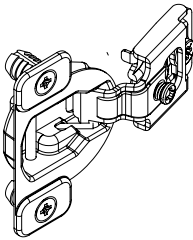
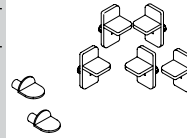
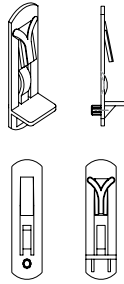
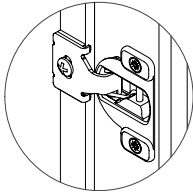
ITEM	MODEL	Qty	Price	ITEM	MODEL	Qty	Price	ITEM	MODEL	Qty	Price
Traditional Overlay 2 Way Hinge	HINTOL2WY-1PR	1	10	3/4" and 5/8" Shelf Clip	SHCLP34	1	2	Shelf Support Pack	SHSUPPK	1	3
	HINTOL2WY-10PR	10	95		SHCLP34-20	20	10		SHSUPPK-25	25	45
Traditional Overlay 6 Way Hinge	HINTOL6WY-1PR	1	21	3/4" and 5/8" Shelf Clip with Stop	SHCLPLK34L	1	1	Shelf Support Pack MG/PM - 24" and 30" High	SHSUPPKMGD24/30	1	3
	HINTOL6WY-10PR	10	200		SHCLPLK34L-20	20	19		SHCLPLK34R	1	1
Medicine Cabinet Pack Hinge	HINMCPK	1	7	Shelf Support Back Pack	SHCLPLK34R-20	20	19	Shelf Support Pack MG/PM - 36" High	SHSUPPKMGD36	1	5
	HINMCPK-10	10	67		SHCLPLK34R	1	1		SHCLPLK58L	1	1
Utility Tray Hinge	HINTOST-1PR	1	10	Shelf Support Center	SHCLPLK58L-20	20	19	Shelf Support Pack MG/PM - 39" and 42" High	SHSUPPKMGD39/42	1	5
					SHCLPLK58R	1	1		SHCLPLK58R-20	20	19

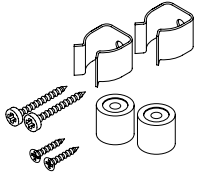
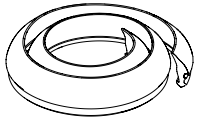

ITEM	MODEL	Qty	Price	ITEM	MODEL	Qty	Price	ITEM	MODEL	Qty	Price
Vent Clip Pack	VNTCLPPK	1	3								
	VNTCLPPK-25	25	71								
											
Door Insert Retaining Strip	DIRS	1	11								
											
Back Plugs	BACKPLUG2H-10	4									
	BACKPLUG2H-100	38									
											

Replacement Parts

How to Use This Section

This section contains pricing for all replacement doors and drawer fronts. They are listed by their nomenclature and sorted by nominal height (last two numbers of the nomenclature) from largest to smallest.

To look up the door(s) and drawer front(s) in the Pricing section, find your door style in the Door Style Index and note the price column number. Then find the replacement door needed in the pricing index under the price column number appropriate to your door style.

Door Style Index

Overlay	Code	Door Style	Price Column
FO	FEL	Felix Cherry	9
FO	FEL	Felix Maple	6
TO	GBL	Gabriel Maple	3
FO	LGH	Lehigh Maple	10
FO	PTN	Peterson Cherry	6
FO	PTN	Peterson Maple	4
FO	RGN	Reagan Maple	6
TO	SHY	Shay Cherry	7
TO	SHY	Shay Maple	5
TO	SHY	Shay Oak	3
TO	SKY	Skylar Cherry	3
TO	SKY	Skylar Maple	2
FO	SKY	Skylar Oak	1
FO	TBN	Tobin Maple	8

Overlay	Code	Door Style	Price Column
FO	SKY	Skylar Oak	1
TO	SKY	Skylar Maple	2
TO	GBL	Gabriel Maple	3
TO	SKY	Skylar Cherry	3
TO	SHY	Shay Oak	3
FO	PTN	Peterson Maple	4
TO	SHY	Shay Maple	5
FO	FEL	Felix Maple	6
FO	PTN	Peterson Cherry	6
FO	RGN	Reagan Maple	6
TO	SHY	Shay Cherry	7
FO	TBN	Tobin Maple	8
FO	FEL	Felix Cherry	9
FO	LGH	Lehigh Maple	10

PART	1	2	3	4	5	6	7	8	9	10
RDF12DP1	56	58	65	69	69	74	81	81	90	94
RDF12DP2	62	63	71	76	76	81	88	88	98	103
RDF12DP3	N/A	N/A	N/A	73	N/A	78	N/A	85	95	100
RDF12STD	50	51	57	61	61	65	72	72	80	84
RDF15DFD	77	79	89	95	95	102	111	111	124	130
RDF15DP1	62	63	71	76	76	81	88	88	98	103
RDF15DP2	66	67	75	81	81	86	94	94	105	111
RDF15DP3	N/A	N/A	N/A	82	N/A	88	N/A	96	107	112
RDF15STD	53	54	61	65	65	70	76	76	85	89
RDF18DFD	84	86	96	103	103	110	120	120	134	141
RDF18DKD	48	49	55	59	59	63	68	68	76	80
RDF18DP1	67	68	77	82	82	88	96	96	107	112
RDF18DP2	71	73	82	87	87	93	102	102	114	119
RDF18DP3	N/A	N/A	N/A	85	N/A	90	N/A	99	110	116
RDF18STD	56	58	65	69	69	74	81	81	90	94
RDF21DFD	90	92	103	111	111	118	129	129	144	152
RDF21DP1	72	74	83	89	89	95	103	103	115	121
RDF21DP2	77	79	89	95	95	102	111	111	124	130
RDF21DP3	N/A	N/A	N/A	91	N/A	97	N/A	107	119	125
RDF21STD	59	61	68	73	73	78	85	85	95	100
RDF21STDUT	59	61	68	73	73	78	85	85	95	100
RDF24DFD	91	93	105	112	112	120	131	131	146	153
RDF24DKD	54	55	62	67	67	71	78	78	86	91
RDF24DP1	80	82	91	98	98	104	114	114	127	134
RDF24DP2	84	86	96	103	103	110	120	120	134	141
RDF24DP3	N/A	N/A	N/A	97	N/A	103	N/A	113	125	132
RDF24STD	62	63	71	76	76	81	88	88	98	103
RDF24STDUBT	59	61	68	73	73	78	85	85	95	100
RDF24STDUT	63	64	72	77	77	82	90	90	100	105
RDF27/2STD	51	52	58	63	63	67	73	73	81	86
RDF27BPPS	84	86	96	103	103	110	120	120	134	141
RDF27DP1	80	82	91	98	98	104	114	114	127	134
RDF27DP2	84	86	96	103	103	110	120	120	134	141
RDF27STD	64	65	73	78	78	83	91	91	102	107
RDF27STDUT	65	66	74	80	80	85	93	93	103	109
RDF30BPPS	105	108	121	129	129	138	151	151	168	176
RDF30DKD	57	59	66	70	70	75	82	82	92	96
RDF30DP2	105	108	121	129	129	138	151	151	168	176
RDF30STD	68	70	78	83	83	89	97	97	109	114
RDF30STDUT	69	71	79	85	85	90	99	99	110	116
RDF33/2STD	54	55	62	67	67	71	78	78	86	91
RDF33BPPS	127	130	146	157	157	167	183	183	203	214
RDF33DP2	89	91	102	110	110	117	128	128	142	150
RDF33STD	73	75	84	90	90	96	105	105	117	123
RDF33STDUT	73	75	84	90	90	96	105	105	117	123
RDF36BPPS	149	152	170	183	183	195	213	213	237	250
RDF36DKD	65	66	74	80	80	85	93	93	103	109
RDF36DP2	118	121	135	145	145	154	169	169	188	198
RDF36STD	76	78	88	94	94	100	110	110	122	128
RDF36STDUT	77	79	89	95	95	102	111	111	124	130
RDF39STD	80	82	91	98	98	104	114	114	127	134
RDF39STDUT	81	83	93	99	99	106	116	116	129	135
RDF45STD	60	62	69	74	74	79	87	87	97	102
RDFBBC36/39STD	48	49	55	59	59	63	68	68	76	80
RDFBBC45/48STD	57	59	66	70	70	75	82	82	92	96
RDFSBA/SFA42STD	63	64	72	77	77	82	90	90	100	105
RDFSFA39STD	59	61	68	73	73	78	85	85	95	100
RDFVCD/VSB60-2DSTD	67	68	77	82	82	88	96	96	107	112

PART	1	2	3	4	5	6	7	8	9	10
RDFVSB60-3DSTD	59	61	68	73	73	78	85	85	95	100
RDO1221	72	74	83	89	89	95	103	103	115	121
RDO1224	77	79	89	95	95	102	111	111	124	130
RDO1227	85	87	97	104	104	111	122	122	136	143
RDO1230	89	91	102	110	110	117	128	128	142	150
RDO1236	106	109	122	130	130	139	152	152	170	178
RDO1239	106	109	122	130	130	139	152	152	170	178
RDO1242	114	116	130	140	140	149	163	163	181	191
RDO1518	75	77	86	93	93	99	108	108	120	127
RDO1521	80	82	91	98	98	104	114	114	127	134
RDO1524	84	86	96	103	103	110	120	120	134	141
RDO1524BWB	84	86	96	103	103	110	120	120	134	141
RDO1527	92	95	106	113	113	121	132	132	148	155
RDO1530	97	99	111	119	119	127	138	138	154	162
RDO1536	116	118	133	142	142	152	166	166	185	194
RDO1539	116	118	133	142	142	152	166	166	185	194
RDO1542	124	127	142	153	153	163	178	178	198	209
RDO15TALL	172	176	197	211	211	225	247	247	275	289
RDO1818	81	83	93	99	99	106	116	116	129	135
RDO1821	85	87	97	104	104	111	122	122	136	143
RDO1824	90	92	103	111	111	118	129	129	144	152
RDO1824BWB	90	92	103	111	111	118	129	129	144	152
RDO1827	100	102	114	123	123	131	143	143	159	168
RDO1830	105	108	121	129	129	138	151	151	168	176
RDO1836	125	128	144	154	154	164	180	180	200	210
RDO1839	125	128	144	154	154	164	180	180	200	210
RDO1842	135	138	155	166	166	177	193	193	215	226
RDO1848	164	168	189	202	202	216	236	236	263	276
RDO18TALL	193	198	222	237	237	253	277	277	309	324
RDO2112	76	78	88	94	94	100	110	110	122	128
RDO2115	80	82	91	98	98	104	114	114	127	134
RDO2118	86	88	99	106	106	113	123	123	137	144
RDO2121	91	93	105	112	112	120	131	131	146	153
RDO2124	100	102	114	123	123	131	143	143	159	168
RDO2127	108	111	124	133	133	142	155	155	173	182
RDO2130	114	116	130	140	140	149	163	163	181	191
RDO2136	135	138	155	166	166	177	193	193	215	226
RDO2139	135	138	155	166	166	177	193	193	215	226
RDO2142	145	149	167	179	179	191	208	208	232	244
RDO2412	79	80	90	97	97	103	113	113	125	132
RDO2415	83	85	95	102	102	109	119	119	132	139
RDO2415B	67	68	77	82	82	88	96	96	107	112
RDO2418	93	96	107	115	115	122	134	134	149	157
RDO2418B	72	74	83	89	89	95	103	103	115	121
RDO2421	99	101	113	121	121	129	142	142	158	166
RDO2421B	76	78	88	94	94	100	110	110	122	128
RDO2424	105	108	121	129	129	138	151	151	168	176
RDO2424B	81	83	93	99	99	106	116	116	129	135
RDO2427	114	116	130	140	140	149	163	163	181	191
RDO2427B	64	65	73	78	78	83	91	91	102	107
RDO2430	122	125	140	150	150	160	175	175	195	205
RDO2430B	92	95	106	113	113	121	132	132	148	155
RDO2436	144	148	166	177	177	189	207	207	231	242
RDO2436B	111	114	128	137	137	146	160	160	178	187
RDO2439	144	148	166	177	177	189	207	207	231	242
RDO2439B	106	109	122	130	130	139	152	152	170	178
RDO2442	169	173	194	207	207	221	242	242	270	283
RDO2442B	119	122	136	146	146	156	170	170	190	200

PART	1	2	3	4	5	6	7	8	9	10
RDO24TALL	224	229	257	275	275	294	321	321	358	376
RDO24TALLB	119	122	136	146	146	156	170	170	190	200
RDO2712B	65	66	74	80	80	85	93	93	103	109
RDO2715B	70	72	80	86	86	92	100	100	112	118
RDO2718B	75	77	86	93	93	99	108	108	120	127
RDO2721B	79	80	90	97	97	103	113	113	125	132
RDO2724	81	83	93	99	99	106	116	116	129	135
RDO2724B	84	86	96	103	103	110	120	120	134	141
RDO2727B	92	95	106	113	113	121	132	132	148	155
RDO2730	92	95	106	113	113	121	132	132	148	155
RDO2730B	97	99	111	119	119	127	138	138	154	162
RDO2736	111	114	128	137	137	146	160	160	178	187
RDO2736B	116	118	133	142	142	152	166	166	185	194
RDO2739	106	109	122	130	130	139	152	152	170	178
RDO2739B	116	118	133	142	142	152	166	166	185	194
RDO2742	119	122	136	146	146	156	170	170	190	200
RDO2742B	124	127	142	153	153	163	178	178	198	209
RDO3012B	67	68	77	82	82	88	96	96	107	112
RDO3015B	73	75	84	90	90	96	105	105	117	123
RDO3015BMMHF	149	152	170	183	183	195	213	213	237	250
RDO3018B	73	75	84	90	90	96	105	105	117	123
RDO3021B	80	82	91	98	98	104	114	114	127	134
RDO3024B	84	86	96	103	103	110	120	120	134	141
RDO3027B	95	98	110	117	117	125	137	137	153	160
RDO3030B	97	99	111	119	119	127	138	138	154	162
RDO3036B	121	124	139	149	149	159	173	173	193	203
RDO3039B	97	99	111	119	119	127	138	138	154	162
RDO3042B	129	133	149	159	159	170	186	186	207	217
RDO30TALLB	172	176	197	211	211	225	247	247	275	289
RDO3312B	87	89	100	107	107	114	125	125	139	146
RDO3315B	77	79	89	95	95	102	111	111	124	130
RDO3318B	87	89	100	107	107	114	125	125	139	146
RDO3321	80	82	91	98	98	104	114	114	127	134
RDO3321B	83	85	95	102	102	109	119	119	132	139
RDO3324	87	89	100	107	107	114	125	125	139	146
RDO3324B	87	89	100	107	107	114	125	125	139	146
RDO3327B	97	99	111	119	119	127	138	138	154	162
RDO3330	101	103	116	124	124	132	145	145	161	169
RDO3330B	87	89	100	107	107	114	125	125	139	146
RDO3336	121	124	139	149	149	159	173	173	193	203
RDO3336B	90	92	103	111	111	118	129	129	144	152
RDO3339	121	124	139	149	149	159	173	173	193	203
RDO3339B	90	92	103	111	111	118	129	129	144	152
RDO3342	129	133	149	159	159	170	186	186	207	217
RDO3342B	90	92	103	111	111	118	129	129	144	152
RDO3612B	71	73	82	87	87	93	102	102	114	119
RDO3615B	68	70	78	83	83	89	97	97	109	114
RDO3618B	64	65	73	78	78	83	91	91	102	107
RDO3621B	92	95	106	113	113	121	132	132	148	155
RDO3624B	69	71	79	85	85	90	99	99	110	116
RDO3627B	73	75	84	90	90	96	105	105	117	123
RDO3630B	77	79	89	95	95	102	111	111	124	130
RDO3636B	121	124	139	149	149	159	173	173	193	203
RDO3639B	121	124	139	149	149	159	173	173	193	203
RDO3642B	136	139	156	167	167	178	195	195	217	228
RDO36TALLB	192	197	220	236	236	252	275	275	307	323
RDO3912	71	73	82	87	87	93	102	102	114	119
RDO3915	77	79	89	95	95	102	111	111	124	130

PART	1	2	3	4	5	6	7	8	9	10
RDO3918	84	86	96	103	103	110	120	120	134	141
RDO3921	86	88	99	106	106	113	123	123	137	144
RDO3924	93	96	107	115	115	122	134	134	149	157
RDO3927	103	105	118	127	127	135	148	148	164	173
RDO3930	110	113	127	136	136	145	158	158	176	185
RDO3936	121	124	139	149	149	159	173	173	193	203
RDO3939	121	124	139	149	149	159	173	173	193	203
RDO3942	136	139	156	167	167	178	195	195	217	228
RDO4512	74	76	85	91	91	97	107	107	119	125
RDO4515	81	83	93	99	99	106	116	116	129	135
RDO4518	89	91	102	110	110	117	128	128	142	150
RDO4524	103	105	118	127	127	135	148	148	164	173
RDO4527	123	126	141	151	151	161	177	177	197	207
RDO4530	118	121	135	145	145	154	169	169	188	198
RDO4536	140	143	161	172	172	184	201	201	224	235
RDO4539	106	109	122	130	130	139	152	152	170	178
RDO4542	151	154	173	185	185	198	216	216	241	253
RDO927	73	75	84	90	90	96	105	105	117	123
RDO930	79	80	90	97	97	103	113	113	125	132
RDO930BPO	79	80	90	97	97	103	113	113	125	132
RDO936	88	90	101	108	108	115	126	126	141	148
RDO939	88	90	101	108	108	115	126	126	141	148
RDO942	103	105	118	127	127	135	148	148	164	173
RDOBBC36/39	76	78	88	94	94	100	110	110	122	128
RDOBCA24BFH	90	92	103	111	111	118	129	129	144	152
RDOBCR33	121	124	139	149	149	159	173	173	193	203
RDOBCR36	147	151	169	181	181	193	212	212	236	248
RDOBLS	157	161	180	N/A	193	N/A	225	N/A	N/A	N/A
RDOSBC60-VCD/VSB6035	84	86	96	103	103	110	120	120	134	141
RDOSFA39	99	101	113	121	121	129	142	142	158	166
RDOSFA42	109	112	125	134	134	143	157	157	175	184
RDOUBCR36	80	82	91	98	98	104	114	114	127	134
RDOUBLS	79	80	90	N/A	97	N/A	113	N/A	N/A	N/A
RDOVB6035FH	98	100	112	120	120	128	140	140	156	164
RDOVB60FH	92	95	106	113	113	121	132	132	148	155
RDOVCD/VSB60	79	80	90	97	97	103	113	113	125	132
RDOVSB6035-4D	95	98	110	117	117	125	137	137	153	160
RDOVSB60-3D	90	92	103	111	111	118	129	129	144	152
RDOWBC24/2730	87	89	100	107	107	114	125	125	139	146
RDOWBC24/2736	95	98	110	117	117	125	137	137	153	160
RDOWBC24/2739	95	98	110	117	117	125	137	137	153	160
RDOWBC24/2742	109	112	125	134	134	143	157	157	175	184
RDOWEZR30	147	151	169	181	181	193	212	212	236	248
RDOWEZR36	169	173	194	207	207	221	242	242	270	283
RDOWEZR39	116	118	133	142	142	152	166	166	185	194
RDOWEZR42	187	191	214	230	230	245	268	268	298	314
RDFSDO	31	35	35	35	35	35	36	35	36	35

PART	1	2	3	4	5	6	7	8	9	10
ANDO1221	72	74	83	89	89	95	103	103	115	121
ANDO1224	77	79	89	95	95	102	111	111	124	130
ANDO1227	85	87	97	104	104	111	122	122	136	143
ANDO1230	89	91	102	110	110	117	128	128	142	150
ANDO1236	106	109	122	130	130	139	152	152	170	178
ANDO1239	106	109	122	130	130	139	152	152	170	178
ANDO1242	114	116	130	140	140	149	163	163	181	191
ANDO1518	75	77	86	93	93	99	108	108	120	127
ANDO1521	80	82	91	98	98	104	114	114	127	134
ANDO1524	84	86	96	103	103	110	120	120	134	141
ANDO1527	92	95	106	113	113	121	132	132	148	155
ANDO1530	97	99	111	119	119	127	138	138	154	162
ANDO1536	116	118	133	142	142	152	166	166	185	194
ANDO1539	116	118	133	142	142	152	166	166	185	194
ANDO1542	124	127	142	153	153	163	178	178	198	209
ANDO15TALL	172	176	197	211	211	225	247	247	275	289
ANDO1818	81	83	93	99	99	106	116	116	129	135
ANDO1821	85	87	97	104	104	111	122	122	136	143
ANDO1824	90	92	103	111	111	118	129	129	144	152
ANDO1827	100	102	114	123	123	131	143	143	159	168
ANDO1830	105	108	121	129	129	138	151	151	168	176
ANDO1836	125	128	144	154	154	164	180	180	200	210
ANDO1839	125	128	144	154	154	164	180	180	200	210
ANDO1842	135	138	155	166	166	177	193	193	215	226
ANDO1848	164	168	189	202	202	216	236	236	263	276
ANDO18TALL	193	198	222	237	237	253	277	277	309	324
ANDO2112	76	78	88	94	94	100	110	110	122	128
ANDO2115	80	82	91	98	98	104	114	114	127	134
ANDO2118	86	88	99	106	106	113	123	123	137	144
ANDO2121	91	93	105	112	112	120	131	131	146	153
ANDO2124	100	102	114	123	123	131	143	143	159	168
ANDO2127	108	111	124	133	133	142	155	155	173	182
ANDO2130	114	116	130	140	140	149	163	163	181	191
ANDO2136	135	138	155	166	166	177	193	193	215	226
ANDO2139	135	138	155	166	166	177	193	193	215	226
ANDO2142	145	149	167	179	179	191	208	208	232	244
ANDO2412	79	80	90	97	97	103	113	113	125	132
ANDO2415	83	85	95	102	102	109	119	119	132	139
ANDO2415B	67	68	77	82	82	88	96	96	107	112
ANDO2418	93	96	107	115	115	122	134	134	149	157
ANDO2418B	72	74	83	89	89	95	103	103	115	121
ANDO2421	99	101	113	121	121	129	142	142	158	166
ANDO2421B	76	78	88	94	94	100	110	110	122	128
ANDO2424	105	108	121	129	129	138	151	151	168	176
ANDO2424B	81	83	93	99	99	106	116	116	129	135
ANDO2427	114	116	130	140	140	149	163	163	181	191
ANDO2427B	64	65	73	78	78	83	91	91	102	107
ANDO2430	122	125	140	150	150	160	175	175	195	205
ANDO2430B	92	95	106	113	113	121	132	132	148	155
ANDO2436	144	148	166	177	177	189	207	207	231	242
ANDO2436B	111	114	128	137	137	146	160	160	178	187
ANDO2439	144	148	166	177	177	189	207	207	231	242
ANDO2439B	106	109	122	130	130	139	152	152	170	178
ANDO2442	169	173	194	207	207	221	242	242	270	283
ANDO2442B	119	122	136	146	146	156	170	170	190	200
ANDO24TALL	224	229	257	275	275	294	321	321	358	376
ANDO24TALLB	119	122	136	146	146	156	170	170	190	200
ANDO2712B	65	66	74	80	80	85	93	93	103	109

PART	1	2	3	4	5	6	7	8	9	10
ANDO2715B	70	72	80	86	86	92	100	100	112	118
ANDO2718B	75	77	86	93	93	99	108	108	120	127
ANDO2721B	79	80	90	97	97	103	113	113	125	132
ANDO2724	81	83	93	99	99	106	116	116	129	135
ANDO2724B	84	86	96	103	103	110	120	120	134	141
ANDO2727B	92	95	106	113	113	121	132	132	148	155
ANDO2730	92	95	106	113	113	121	132	132	148	155
ANDO2730B	97	99	111	119	119	127	138	138	154	162
ANDO2736	111	114	128	137	137	146	160	160	178	187
ANDO2736B	116	118	133	142	142	152	166	166	185	194
ANDO2739	106	109	122	130	130	139	152	152	170	178
ANDO2739B	116	118	133	142	142	152	166	166	185	194
ANDO2742	119	122	136	146	146	156	170	170	190	200
ANDO2742B	124	127	142	153	153	163	178	178	198	209
ANDO3012B	67	68	77	82	82	88	96	96	107	112
ANDO3015B	73	75	84	90	90	96	105	105	117	123
ANDO3018B	73	75	84	90	90	96	105	105	117	123
ANDO3021B	80	82	91	98	98	104	114	114	127	134
ANDO3024B	84	86	96	103	103	110	120	120	134	141
ANDO3027B	95	98	110	117	117	125	137	137	153	160
ANDO3030B	97	99	111	119	119	127	138	138	154	162
ANDO3036B	121	124	139	149	149	159	173	173	193	203
ANDO3039B	97	99	111	119	119	127	138	138	154	162
ANDO3042B	129	133	149	159	159	170	186	186	207	217
ANDO30TALLB	172	176	197	211	211	225	247	247	275	289
ANDO3312B	87	89	100	107	107	114	125	125	139	146
ANDO3315B	77	79	89	95	95	102	111	111	124	130
ANDO3318B	87	89	100	107	107	114	125	125	139	146
ANDO3321	80	82	91	98	98	104	114	114	127	134
ANDO3321B	83	85	95	102	102	109	119	119	132	139
ANDO3324	87	89	100	107	107	114	125	125	139	146
ANDO3324B	87	89	100	107	107	114	125	125	139	146
ANDO3327B	97	99	111	119	119	127	138	138	154	162
ANDO3330	101	103	116	124	124	132	145	145	161	169
ANDO3330B	87	89	100	107	107	114	125	125	139	146
ANDO3336	121	124	139	149	149	159	173	173	193	203
ANDO3336B	90	92	103	111	111	118	129	129	144	152
ANDO3339	121	124	139	149	149	159	173	173	193	203
ANDO3339B	90	92	103	111	111	118	129	129	144	152
ANDO3342	129	133	149	159	159	170	186	186	207	217
ANDO3342B	90	92	103	111	111	118	129	129	144	152
ANDO3612B	71	73	82	87	87	93	102	102	114	119
ANDO3615B	68	70	78	83	83	89	97	97	109	114
ANDO3618B	64	65	73	78	78	83	91	91	102	107
ANDO3621B	92	95	106	113	113	121	132	132	148	155
ANDO3624B	69	71	79	85	85	90	99	99	110	116
ANDO3627B	73	75	84	90	90	96	105	105	117	123
ANDO3630B	77	79	89	95	95	102	111	111	124	130
ANDO3636B	121	124	139	149	149	159	173	173	193	203
ANDO3639B	121	124	139	149	149	159	173	173	193	203
ANDO3642B	136	139	156	167	167	178	195	195	217	228
ANDO36TALLB	192	197	220	236	236	252	275	275	307	323
ANDO3912	71	73	82	87	87	93	102	102	114	119
ANDO3915	77	79	89	95	95	102	111	111	124	130
ANDO3918	84	86	96	103	103	110	120	120	134	141
ANDO3921	86	88	99	106	106	113	123	123	137	144
ANDO3924	93	96	107	115	115	122	134	134	149	157
ANDO3927	103	105	118	127	127	135	148	148	164	173

PART	1	2	3	4	5	6	7	8	9	10
ANDO3930	110	113	127	136	136	145	158	158	176	185
ANDO3936	121	124	139	149	149	159	173	173	193	203
ANDO3939	121	124	139	149	149	159	173	173	193	203
ANDO3942	136	139	156	167	167	178	195	195	217	228
ANDO4512	74	76	85	91	91	97	107	107	119	125
ANDO4515	81	83	93	99	99	106	116	116	129	135
ANDO4518	89	91	102	110	110	117	128	128	142	150
ANDO4524	103	105	118	127	127	135	148	148	164	173
ANDO4527	123	126	141	151	151	161	177	177	197	207
ANDO4530	118	121	135	145	145	154	169	169	188	198
ANDO4536	140	143	161	172	172	184	201	201	224	235
ANDO4539	106	109	122	130	130	139	152	152	170	178
ANDO4542	151	154	173	185	185	198	216	216	241	253
ANDO927	73	75	84	90	90	96	105	105	117	123
ANDO930	79	80	90	97	97	103	113	113	125	132
ANDO936	88	90	101	108	108	115	126	126	141	148
ANDO939	88	90	101	108	108	115	126	126	141	148
ANDO942	103	105	118	127	127	135	148	148	164	173
ANDOBBC36/39	76	78	88	94	94	100	110	110	122	128
ANODOBCA24BFH	90	92	103	111	111	118	129	129	144	152
ANODOBCR33	121	124	139	149	149	159	173	173	193	203
ANODOBCR36	147	151	169	181	181	193	212	212	236	248
ANDOMDEP	99	101	113	121	121	129	142	142	158	166
ANDOMTEP1218	70	72	80	86	86	92	100	100	112	118
ANDOMTEP12TALL	157	161	180	193	193	206	225	225	251	264
ANDOMTEP21TALL	192	197	220	236	236	252	275	275	307	323
ANDOSBC60-VCD/VSB6035	84	86	96	103	103	110	120	120	134	141
ANDOSFA39	99	101	113	121	121	129	142	142	158	166
ANDOSFA42	109	112	125	134	134	143	157	157	175	184
ANDOUBCR36	80	82	91	98	98	104	114	114	127	134
ANDOV6035FH	98	100	112	120	120	128	140	140	156	164
ANDOV60FH	92	95	106	113	113	121	132	132	148	155
ANDOVCD/VSB60	79	80	90	97	97	103	113	113	125	132
ANDOVSB6035-4D	95	98	110	117	117	125	137	137	153	160
ANDOVSB60-3D	90	92	103	111	111	118	129	129	144	152
ANDOWBC24/2730	87	89	100	107	107	114	125	125	139	146
ANDOWBC24/2736	95	98	110	117	117	125	137	137	153	160
ANDOWBC24/2739	95	98	110	117	117	125	137	137	153	160
ANDOWBC24/2742	109	112	125	134	134	143	157	157	175	184
ANDOWEZR30	147	151	169	181	181	193	212	212	236	248
ANDOWEZR36	169	173	194	207	207	221	242	242	270	283
ANDOWEZR39	116	118	133	142	142	152	166	166	185	194
ANDOWEZR42	187	191	214	230	230	245	268	268	298	314

ITEM	PAGE	ITEM	PAGE	ITEM	PAGE
F		L		Q	
Face Mount Hinge.....	L5	Labelle Cherry Square.....	A1	Quarter Round Molding.....	K3
Fill Stick.....	L1	Labelle Maple Square.....	A1	R	
Filler Angle.....	D14, E15, G9	Lariat Cherry Square.....	A1	Radius Cabinet Molding.....	K3
Filler Overlay.....	D14, E15, F8, G9	Lariat Maple Square.....	A1	Ralston Cherry Square.....	A2
Fluted Filler Angle.....	D14, E15, G9	Lazy Susan Revolving Shelf Kit (One Shelf) D13		Ralston Maple Square.....	A2
Foil Box Rack.....	E13	Lazy Susan Revolving Shelf Kit (Three Shelves).....	D13	Range Hood Blower and Light Unit.....	D12
Fox Harbor Cherry Square.....	A1	Library Molding.....	K3	Range Hood Front Spindle Railing.....	D12
Fox Harbor Maple Square.....	A1	Locking Device - Full Extension Heavy Duty Under Mount Soft Action+™ Guides.....	L4	Rear Adjustment Adapter - Full Extension Heavy Duty Under Mount Soft Action+™ Guides.....	L5
Full Depth Shelf.....	C1	Locking Device - Full Extension Under Mount Soft Action+™ Guides.....	L4	Rear Mounting Bracket - 3/4 Extension Side Mount Roller Guides.....	L5
Full Extension Heavy Duty Under Mount Soft Action+™ Guide Set.....	L4	M		Rear Mounting Bracket - 3/4 Extension Side Mount Roller Guides Peninsula Base.....	L5
Full Extension Side Mount Ball Bearing Guide Kit.....	L4	Matching Base End Panel.....	E17	Rear Mounting Bracket - Full Extension Side Mount Ball Bearing Guides.....	L5
Full Extension Side Mount Ball Bearing Guides.....	L4	Matching Desk End Panel.....	H3	Rear Mounting Bracket - Full Extension Under Mount Soft Action+™ Guides.....	L5
Full Extension Under Mount Soft Action+™ Guides.....	L4	Matching Interior.....	C2	Rear Mounting Bracket - Full Extension Under Mount Soft Action+™ Guides DKD.....	L5
Full Extension Under Mount Soft Action+™ Peninsula Base Guide Kit.....	L4	Matching Tall End Panel.....	F9	Rear Mounting Bracket - Full Extension Under Mount Soft Action+™ Guides Peninsula Base.....	L5
Full Extension Under Mount Soft Action+™ Full Extension Under Mount Soft Action+™ Guide Kit.....	L4	Matching Vanity End Panel.....	G10	Refrigerator End Panel.....	F7
Full Overlay 4 Way Hinge.....	L5	Matching Wall End Panel.....	D16	Removable Sink Front Double Door.....	E8
Full Overlay 6 Way Hinge.....	L5	Medicine Cabinet.....	G8	Roll-Out Trays - Solid Wood.....	J4
Furniture Base.....	K3	Medicine Cabinet Pack Hinge.....	L6	Rope Molding.....	K4
Furniture End Panels.....	F8	Mirror Molding.....	K3	Rusty Flower Knob.....	K8
Furniture Shelf Kit.....	J2	Mullion Glass Doors.....	C1	S	
Fusion Cherry Slab.....	A1	N		Sable.....	B1
Fusion Maple Slab.....	A1	Narrow Batten Molding.....	K3	Sable w/Ebony Accent.....	B1
G		Natural.....	B1	Sable w/Ebony Glaze.....	B1
Galley Rail.....	K3	Natural w/Java Accent.....	B1	Sales Door.....	L2
Glass Doors.....	C1	Natural w/Java Glaze.....	B1	Satin Aluminum Boat Cleat	
Glen Arbor Cherry Square.....	A1	O		Transitional Pull.....	K10
Glen Arbor Maple Square.....	A1	Ochre Finished Ceramic Totem Knob.....	K9	Satin Aluminum Knob.....	K8
Glen Arbor Red Oak Square.....	A1	Ochre Finished Ceramic Totem Pull.....	K10	Satin Nickel Canoe Pull.....	K10
H		Oil Rubbed Bronze Cup Pull.....	K10	Satin Nickel Diminishing Knob.....	K9
Half Depth Shelf.....	C1	Oil Rubbed Bronze Round Knob.....	K8	Satin Nickel Football Shaped Knob.....	K8
Hardware Template Kit Universal.....	L3	Open Cube Organizer.....	D13	Satin Nickel Fusilli Pull.....	K10
Hazlenut.....	B1	Organizer.....	H2	I	
Hazlenut w/Java Accent.....	B1	Oven Cabinet Single.....	F5	Inset Light Rail.....	K3
Hazlenut w/Java Glaze.....	B1	Oven Cabinet Support Platform.....	F7	K	
Heat Shield.....	E12	Oven Cabinet Universal.....	F5	Kona.....	B1
Heavy Duty Furniture Shelf Kit.....	J2	Oven Drawer Kit.....	F6	Knife Section Cutting Center Kit.....	E13
I		P		J	
K		Panel Backer 3' Tall-Paper.....	J1	Panel Backer 3' Tall-Paper.....	J1
L		Panel Backer 3' Tall-Veneer.....	J1	Panel Backer-Paper.....	J1
M		Panel Backer-Paper.....	J1	Panel Backer-Veneer.....	J1
N		Panel Backer-Veneer.....	J1	Pantry Cabinet Butt Door.....	F3
O		Paprika.....	B1	Paprika.....	B1
P		Paprika w/Ebony Glaze.....	B1	Paprika w/Ebony Glaze.....	B1
Q		Pecan.....	B1	Pegged Deep Drawer Organizer.....	E13
R		Peninsula Base Butt Door.....	E2	Peninsula Base Butt Door.....	E2
S		L		M	
Sable.....	B1	Labelle Cherry Square.....	A1	Matching Base End Panel.....	E17
Sable w/Ebony Accent.....	B1	Labelle Maple Square.....	A1	Matching Desk End Panel.....	H3
Sable w/Ebony Glaze.....	B1	Lariat Cherry Square.....	A1	Matching Interior.....	C2
Sales Door.....	L2	Lariat Maple Square.....	A1	Matching Tall End Panel.....	F9
Satin Aluminum Boat Cleat		Lazy Susan Revolving Shelf Kit (One Shelf) D13		Matching Vanity End Panel.....	G10
Transitional Pull.....	K10	Lazy Susan Revolving Shelf Kit (Three Shelves).....	D13	Matching Wall End Panel.....	D16
Satin Aluminum Knob.....	K8	Library Molding.....	K3	Medicine Cabinet.....	G8
Satin Nickel Canoe Pull.....	K10	Locking Device - Full Extension Heavy Duty Under Mount Soft Action+™ Guides.....	L4	Medicine Cabinet Pack Hinge.....	L6
Satin Nickel Diminishing Knob.....	K9	Locking Device - Full Extension Under Mount Soft Action+™ Guides.....	L4	Mirror Molding.....	K3
Satin Nickel Football Shaped Knob.....	K8	M		Mullion Glass Doors.....	C1
Satin Nickel Fusilli Pull.....	K10	Matching Base End Panel.....	E17	N	
T		Matching Desk End Panel.....	H3	Narrow Batten Molding.....	K3
U		Matching Interior.....	C2	Natural.....	B1
V		Matching Tall End Panel.....	F9	Natural w/Java Accent.....	B1
W		Matching Vanity End Panel.....	G10	Natural w/Java Glaze.....	B1
X		Matching Wall End Panel.....	D16	O	
Y		Medicine Cabinet.....	G8	Ochre Finished Ceramic Totem Knob.....	K9
Z		Medicine Cabinet Pack Hinge.....	L6	Ochre Finished Ceramic Totem Pull.....	K10
		Mirror Molding.....	K3	Oil Rubbed Bronze Cup Pull.....	K10
		Mullion Glass Doors.....	C1	Oil Rubbed Bronze Round Knob.....	K8
		N		Open Cube Organizer.....	D13
		Narrow Batten Molding.....	K3	Organizer.....	H2
		Natural.....	B1	Oven Cabinet Single.....	F5
		Natural w/Java Accent.....	B1	Oven Cabinet Support Platform.....	F7
		Natural w/Java Glaze.....	B1	Oven Cabinet Universal.....	F5
		O		Oven Drawer Kit.....	F6
		Ochre Finished Ceramic Totem Knob.....	K9	P	
		Ochre Finished Ceramic Totem Pull.....	K10	Panel Backer 3' Tall-Paper.....	J1
		Oil Rubbed Bronze Cup Pull.....	K10	Panel Backer 3' Tall-Veneer.....	J1
		Oil Rubbed Bronze Round Knob.....	K8	Panel Backer-Paper.....	J1
		Open Cube Organizer.....	D13	Panel Backer-Veneer.....	J1
		Organizer.....	H2	Pantry Cabinet Butt Door.....	F3
		Oven Cabinet Single.....	F5	Paprika.....	B1
		Oven Cabinet Support Platform.....	F7	Paprika w/Ebony Glaze.....	B1
		Oven Cabinet Universal.....	F5	Pecan.....	B1
		Oven Drawer Kit.....	F6	Pegged Deep Drawer Organizer.....	E13
		P		Peninsula Base Butt Door.....	E2
		Panel Backer 3' Tall-Paper.....	J1	Q	
		Panel Backer 3' Tall-Veneer.....	J1	Quarter Round Molding.....	K3
		Panel Backer-Paper.....	J1	R	
		Panel Backer-Veneer.....	J1	Radius Cabinet Molding.....	K3
		Pantry Cabinet Butt Door.....	F3	Ralston Cherry Square.....	A2
		Paprika.....	B1	Ralston Maple Square.....	A2
		Paprika w/Ebony Glaze.....	B1	Range Hood Blower and Light Unit.....	D12
		Pecan.....	B1	Range Hood Front Spindle Railing.....	D12
		Pegged Deep Drawer Organizer.....	E13	Rear Adjustment Adapter - Full Extension Heavy Duty Under Mount Soft Action+™ Guides.....	L5
		Peninsula Base Butt Door.....	E2	Rear Mounting Bracket - 3/4 Extension Side Mount Roller Guides.....	L5
		L		Rear Mounting Bracket - 3/4 Extension Side Mount Roller Guides Peninsula Base.....	L5
		Labelle Cherry Square.....	A1	Rear Mounting Bracket - Full Extension Side Mount Ball Bearing Guides.....	L5
		Labelle Maple Square.....	A1	Rear Mounting Bracket - Full Extension Under Mount Soft Action+™ Guides.....	L5
		Lariat Cherry Square.....	A1	Rear Mounting Bracket - Full Extension Under Mount Soft Action+™ Guides DKD.....	L5
		Lariat Maple Square.....	A1	Rear Mounting Bracket - Full Extension Under Mount Soft Action+™ Guides Peninsula Base.....	L5
		Lazy Susan Revolving Shelf Kit (One Shelf) D13		Refrigerator End Panel.....	F7
		Lazy Susan Revolving Shelf Kit (Three Shelves).....	D13	Removable Sink Front Double Door.....	E8
		Library Molding.....	K3	Roll-Out Trays - Solid Wood.....	J4
		Locking Device - Full Extension Heavy Duty Under Mount Soft Action+™ Guides.....	L4	Rope Molding.....	K4
		Locking Device - Full Extension Under Mount Soft Action+™ Guides.....	L4	Rusty Flower Knob.....	K8
		M		S	
		Matching Base End Panel.....	E17	Sable.....	B1
		Matching Desk End Panel.....	H3	Sable w/Ebony Accent.....	B1
		Matching Interior.....	C2	Sable w/Ebony Glaze.....	B1
		Matching Tall End Panel.....	F9	Sales Door.....	L2
		Matching Vanity End Panel.....	G10	Satin Aluminum Boat Cleat	
		Matching Wall End Panel.....	D16	Transitional Pull.....	K10
		Medicine Cabinet.....	G8	Satin Aluminum Knob.....	K8
		Medicine Cabinet Pack Hinge.....	L6	Satin Nickel Canoe Pull.....	K10
		Mirror Molding.....	K3	Satin Nickel Diminishing Knob.....	K9
		Mullion Glass Doors.....	C1	Satin Nickel Football Shaped Knob.....	K8
		N		Satin Nickel Fusilli Pull.....	K10
		Narrow Batten Molding.....	K3	T	
		Natural.....	B1	U	
		Natural w/Java Accent.....	B1	V	
		Natural w/Java Glaze.....	B1	W	
		O		X	
		Ochre Finished Ceramic Totem Knob.....	K9	Y	
		Ochre Finished Ceramic Totem Pull.....	K10	Z	
		Oil Rubbed Bronze Cup Pull.....	K10		
		Oil Rubbed Bronze Round Knob.....	K8		
		Open Cube Organizer.....	D13		
		Organizer.....	H2		
		Oven Cabinet Single.....	F5		
		Oven Cabinet Support Platform.....	F7		
		Oven Cabinet Universal.....	F5		
		Oven Drawer Kit.....	F6		
		P			
		Panel Backer 3' Tall-Paper.....	J1		
		Panel Backer 3' Tall-Veneer.....	J1		
		Panel Backer-Paper.....	J1		
		Panel Backer-Veneer.....	J1		
		Pantry Cabinet Butt Door.....	F3		
		Paprika.....	B1		
		Paprika w/Ebony Glaze.....	B1		
		Pecan.....	B1		
		Pegged Deep Drawer Organizer.....	E13		
		Peninsula Base Butt Door.....	E2		

ITEM	PAGE	ITEM	PAGE	ITEM	PAGE		
Satin Nickel Knob	K8	Spring Valley Hickory Square	A2	U	Under Cabinet Corner Shelf	D13	
Satin Nickel Rope Knob.....	K8	Spring Valley Maple Arch	A2		Under Cabinet Molding	K5	
Satin Nickel Rope Pull	K10	Spring Valley Maple Square.....	A2		Under Cabinet Shelf	D13	
Satin Nickel Suitcase Pull	K10	Spring Valley Red Oak Arch	A2		Under Sink Tote	E14	
Satin Nickel Traditional Pull.....	K10	Spring Valley Red Oak Square.....	A3		Universal Access Panel	J1	
Satin Nickel Wavy Pull	K10	Standard Construction	C1		Universal Base Corner Revolving.....	I2	
Satin Nickel Wire Cable Pull.....	K10	Starter Molding	K5		Universal Base Double Door.....	I1	
Scribe Cove Molding	K4	Stem Glass Holder	D13		Universal Base Double Door - Full-Height ...	I1	
Scribe Molding	K4	Sutton Cliffs Cherry Arch	A3		Universal Base Lazy Susan	I2	
Sedona	B1	Sutton Cliffs Cherry Square	A3		Universal Base Single Door	I1	
Sedona w/Ebony Accent.....	B1	Sutton Cliffs Hickory Arch	A3		Universal Base Single Door - Full-Height ...	I1	
Seneca Ridge Cherry Arch	A2	Sutton Cliffs Hickory Square	A3		Universal Base Sink Front Butt Door - Full- Height	I2	
Seneca Ridge Cherry Square.....	A2	Sutton Cliffs Maple Arch	A3		Universal Base Sink Front Cabinet Kit - Full- Height	I2	
Seneca Ridge Maple Arch.....	A2	Sutton Cliffs Maple Square	A3		Universal Base Table Butt Door	I1	
Seneca Ridge Maple Square	A2	Sutton Cliffs Red Oak Arch.....	A3	Universal Base Three Drawer.....	I2		
Seneca Ridge Red Oak Arch	A2	Sutton Cliffs Red Oak Square	A3	Universal Base Toekick Cover - Laminate ...	I4		
Seneca Ridge Red Oak Square	A2	Swing-Out Pantry Rack	F4	Universal Base Toekick Cover - Veneer.....	I4		
Shale	B1	T	Tall End Panel	F8	Universal Removable Sink Front Double Doors	I3	
Shelf Kits.....	J3		Tall End Panel Filler	F8	Utility Front	F3	
Shelf Support Back Pack.....	L6		Tall Filler	F8, G9	Utility Tray Hinge.....	L6	
Shelf Support Center	L6		Tall Fluted Filler	F8, G9	Utility Tray Kit	E13	
Shelf Support Pack	L6		Tall Utility Cabinet 12" Deep	F1	V	V- Groove Panel	J1
Shelf Support Pack MG/PM - 24" and 30" High	L6		Tall Utility Cabinet 24" Deep	F2		Valance Raised Panel	K1
Shelf Support Pack MG/PM - 36" High.....	L6		Tapered Foot.....	K7		Valance Shaker	K1
Shelf Support Pack MG/PM - 39" and 42" High	L6		Tapered Leg Base	K7		Valance Traditional	K1
Shelf Top and Bottom	J2		Tapestry Corbel Large	K6		Vanity Base Double Door	G1
Shoe Molding	K4		Tapestry Corbel Small	K6		Vanity Base Double Door Full-Height	G2
Single Bead Pilaster	K4		Tapestry Foot	K6		Vanity Base Four Door Full-Height	G3
Single Bead Trim	K4		Tapestry Insert Molding	K5		Vanity Base Single Door	G1
Sink Base Angle	E7		Tapestry Leg Base	K6		Vanity Base Single Door Full-Height	G1
Sink Base Double Door	E5, E6		Toeboard/Valance	J2		Vanity Base Three Door Full-Height	G3
Sink Base Double Door Full-Height	E6	Toekick Backer	E14	Vanity Combination Drawer Eight Drawer Double Door		G5	
Sink Base Single Door	E5	Toekick Cover - Laminate	K5	Vanity Combination Drawer Eight Drawer Single Door		G5	
Sink Base Single Door Full-Height	E5	Toekick Cover - Veneer	K5	Vanity Combination Drawer Six Drawer Double Door		G5	
Sink Front Angle	E7	Toffee.....	B1	Vanity Combination Drawer Six Drawer Single Door		G5	
Sink Front Angle Full-Height	E8	Toffee w/Java Accent.....	B1	Vanity Combination Drawer Three Drawer .	G5		
Sink Front Bottom	E8	Toffee w/Java Glaze	B1	Vanity Combination Drawer Two Drawer ..	G4		
Sink Front Diagonal Bottom	E8	Tolani Cherry Square	A3	Vanity Drawer Four Drawer	G6		
Sink Front Double Door	E7	Tolani Maple Square.....	A3	Vanity Drawer Three Drawer	G6		
Sink Front Double Door Full-Height	E7	Tolani Red Oak Square.....	A3	Vanity Filler	G9		
Sink Front Single Door	E6	Touch Up Kit	L1	Vanity Fluted Filler	G9		
Sink Front Single Door Full-Height	E7	Touch Up Pen	L1	Vanity Hamper Roll-Out	G9		
Sliding Towel Bar - Chrome	E13	Touch Up Quart	L1	Vanity Linen Cabinet	G6		
Soffit Crown Molding.....	K2	Touch Up Spray Can Primer	L1	Vanity Linen Cabinet Tall	G7		
SoftAction™ Door Hardware	L3	Touch Up Spray Can Topcoat	L1	Vanity Sink Base Butt Door	G3		
Solid Bright Brass Knob.....	K8	Towel Bar	E13	Vanity Sink Base Double Bowl	G3		
Solid Wood Stock	K4	Traditional Overlay 2 Way Hinge	L6	Vanity Sink Base Two Drawer Double Door	G4		
Solid Wood Wall End Open Shelf	D8	Traditional Overlay 6 Way Hinge	L6	Vanity Sink Base Two Drawer Four Door ..	G4		
Somerton Hill Cherry Arch	A2	Tri-View Medicine Cabinet	G8				
Somerton Hill Cherry Square	A2	Triple Bead Edging	K5				
Somerton Hill Maple Arch	A2	Triple Bead Pilaster	K5				
Somerton Hill Maple Square.....	A2	Tumbled Dark Gunmetal Mission Style Ringed Pendant Pull	K10				
Spice Drawer Insert Kit	E13	Tumbled Dark Gunmetal Round Knob	K8				
Spice Drawer Organizer	D13						
Spindles	K7						
Spring Valley Cherry Arch.....	A2						
Spring Valley Cherry Square	A2						
Spring Valley Hickory Arch	A2						

Vanity Sink Base Two Drawer Three Door .G4
 Vanity Tray Kit..... J4
 Vanity Tray Kit - Space Saver..... J4
 Vanity Wall - 4 3/4" DeepG7
 Vanity Wall Boutique - 7" DeepG7
 Vanity Wall Boutique - 8" DeepG7
 Venetian Bronze Copper French Lace Knob K9
 Vent Clip Pack.....L7

W

Wall Angle Single Door.....D6, D7
 Wall Blind Corner Double Door.....D6
 Wall Blind Corner Single Door.....D6
 Wall Box..... D14
 Wall China Display.....D8
 Wall Column Fluted..... D15
 Wall Corner Angle.....D7
 Wall Double Door.....D2, D3, D4
 Wall Easy Reach.....D7
 Wall End Corner.....D7
 Wall End Panel..... D15
 Wall Filler..... D13
 Wall Filler Corner..... D14
 Wall Fluted Filler..... D14
 Wall Hood Blower..... D12
 Wall Hood Classic Chimney Plain..... D12
 Wall Hood Cove..... D12
 Wall Hood Liner..... D12
 Wall Lattice.....D8
 Wall Microwave Cabinet..... D10
 Wall Microwave Shelf.....D9
 Wall Microwave Shelf Cabinet..... D10
 Wall Pull-Out Filler..... D14
 Wall Refrigerator.....D4
 Wall Single Door.....D1
 Wall Wine Rack Scalloped.....D8
 White.....B1
 White Ceramic Knob.....K8
 White Fusilli Pull.....K10
 Whitebay II Thermofoil Arch.....A3
 Whitebay II Thermofoil Square.....A3
 Windmere Corbel Large.....K6
 Windmere Corbel Small.....K6
 Windmere Foot.....K7
 Windmere Leg Base.....K7
 Windmere Rope Molding.....K5
 Wire Tray Divider Kit.....E13
 Wire Tray Divider Roll-Out.....E13

Construction



Base Cabinets

1. Constructed for daily use (3/8" thick end panels attached with wood-to-wood glue and staples)
2. Moisture resistant (woodgrain laminate interiors)
3. Strong and sturdy frames (1½" wide front, 3/8" thick, solid wood)
4. Reinforced components (1/4" thick engineered wood back extends all the way to the floor for added strength to help reinforce back corners of the cabinet)
5. Overall strength (solid pine or Douglas fir hang rails provide greater rigidity)
6. 6-way, fully concealed, adjustable hinges
7. Structurally square design (four 1/2" thick engineered wood gussets help keep cabinet square and are dado cut into the side panels to improve the strength of the cabinet)
8. 1/2" thick engineered wood drawers feature natural colored woodgrain laminate interiors
9. Better alignment (dual-captured, self-aligning white drawer guides are side-mounted and hold up to 75 lbs.)
10. Sturdy under-shelf support (locking shelf clips help hold shelf securely; cabinets 39" and wider also have support cleats as shown)
11. Strong shelves (5/8" thick engineered wood; natural woodgrain laminate in color makes the use of shelf paper optional)



Quality Series

QualityCabinets offers a 10-Year Limited Warranty from the date of purchase. Full warranty details are available from your dealer or at www.QualityCabinets.com.

Learn more about planning and visit the Idea Gallery at www.QualityCabinets.com

