

LIST PRICING & PRODUCT SPECIFICATIONS

Effective June 10, 2019



WOLF HOME PRODUCTS®

OUTDOOR
CABINETRY

WOLF ENDURANCE

ENDURANCE

Wolf Endurance is affordable deck, patio, hardscape and garage cabinetry designed to last a lifetime. Aluminum construction provides superior strength and performance. Endurance cabinetry will not rust, swell or warp from moisture and is highly resistant to mold and mildew. Plus, Endurance is lightweight and easy to configure and install.

Endurance Cabinetry provides customers the freedom to utilize cabinetry in almost any setting, including elevated decks, roof top decks, patios and garages.



LIGHTWEIGHT

Easy to handle and install.



Freestanding - Shaker, White



Hardscape Insert - Flat, Black



EASY TO CONFIGURE AND INSTALL

Custom configurations and adjustable legs that accommodate every surface.

ALUMINUM CONSTRUCTION

Endurance cabinetry's all aluminum construction is comprised of bent panel subassemblies with welded inset frames that provide outstanding structural strength and aesthetic appeal. Freestanding cabinets and hardscape inserts are available with Flat and Shaker door styles. All door and drawer opening are sealed with a EPDM D-Seal to insure a weather resistant interior. All exterior hardware is 304 stainless steel, again making it perfect for outdoor applications.

Structural Reference: 36" wide open cabinet is stable up to a 750lb static load.



ALUMINUM CONSTRUCTION

Durable construction at a cost substantially less stainless steel.



FULLY ASSEMBLED

Freestanding and ready to use right away.



SEALED STORAGE

Keeps supplies dry inside, and rain and moisture outside.

DOOR STYLES

FLAT

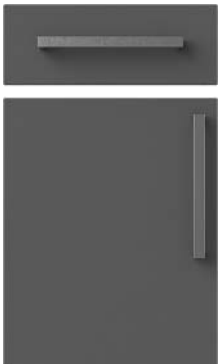

- Flat Panel Door Style
- Flat Panel Drawer Front
- Inset Door and Drawer Front
- Available on Freestanding and Hardscape Insert Cabinetry
- Colors: Ash, Black and White
- Hardware included

SHAKER



- Shaker Door Style
- Flat Panel Drawer Front
- Inset Door and Drawer Front
- Available on Freestanding and Hardscape Insert Cabinetry
- Color: Ash, Black and White
- Hardware included



WOLF ENDURANCE CABINETS ARE MADE FROM MORE THAN **25% RECYCLED MATERIALS**

CABINET SPECIFICATIONS

FREESTANDING CABINETRY

DOOR STYLE	COLOR	CODE	IN STOCK	SPECIAL ORDER
FLAT	Ash	080	Yes	Yes
	Black	081	Yes	Yes
	White	082	Yes	Yes
SHAKER	Ash	070	No	Yes
	Black	071	No	Yes
	White	072	No	Yes

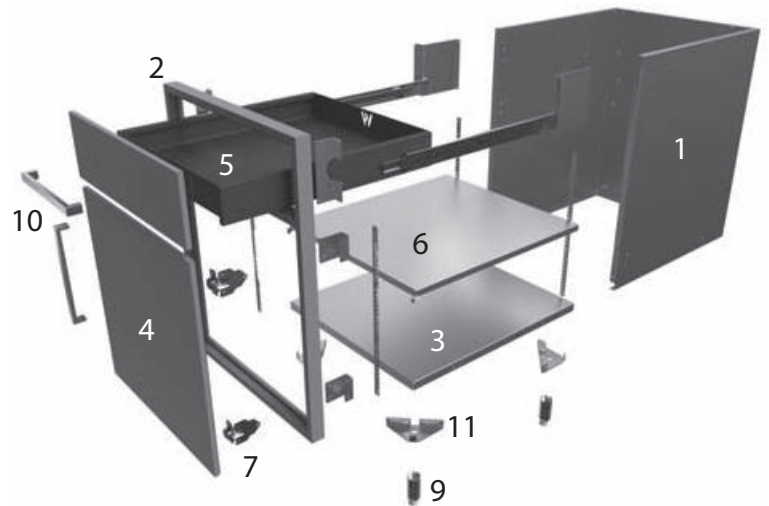

		Description
1	BOX	Seamless, one-piece side and back panel (.040 mill finish aluminum) bent for strength
2	FRAME	All aluminum, welded assembly featuring inset face frames and weather resistant powder coating
3	BOTTOM	One-piece fabricated (.060 mill finish aluminum) panel assembly
4	DOORS	Flat or Shaker door styles with matching powder coated exterior. Flat style has a painted black aluminum panel on back of the door and Shaker has a matching finish on back of door
5	DRAWERS	24" deep, aluminum, powder coat finish drawer box with 100lb full extension side mount ball bearing glides. EPDM D-seal around frame to insure a weather and pest resistant seal
6	SHELVES	Adjustable 3/4" high, full-depth shelf (.060 aluminum) with self-locking clips (60lb load rating)
7	HINGES	110 degree concealed hinge with 6 way adjustability
8	CATCH	Clip and double roller catch (not shown above)
9	LEGS	1 5/8" diameter, 4" tall, 304 stainless steel legs, adjustable up to 2"
10	PULLS	304 stainless steel bar pulls
11	LEG BRACKET	Pass through allows for cable tie down
12	SIDE PANEL	Matching finish panel quickly install on exposed sides
13	BACK PANEL	Matching finish panels installs on exposed cabinet backs to create a freestanding application Solid construction and ventilated for grill applications are available

CABINET SPECIFICATIONS

HARDSCAPE INSERT CABINETRY

DOOR STYLE	COLOR	CODE	IN STOCK	SPECIAL ORDER
FLAT	Ash	083	No	Yes
	Black	084	No	Yes
	White	085	No	Yes
SHAKER	Ash	073	No	Yes
	Black	074	No	Yes
	White	075	No	Yes

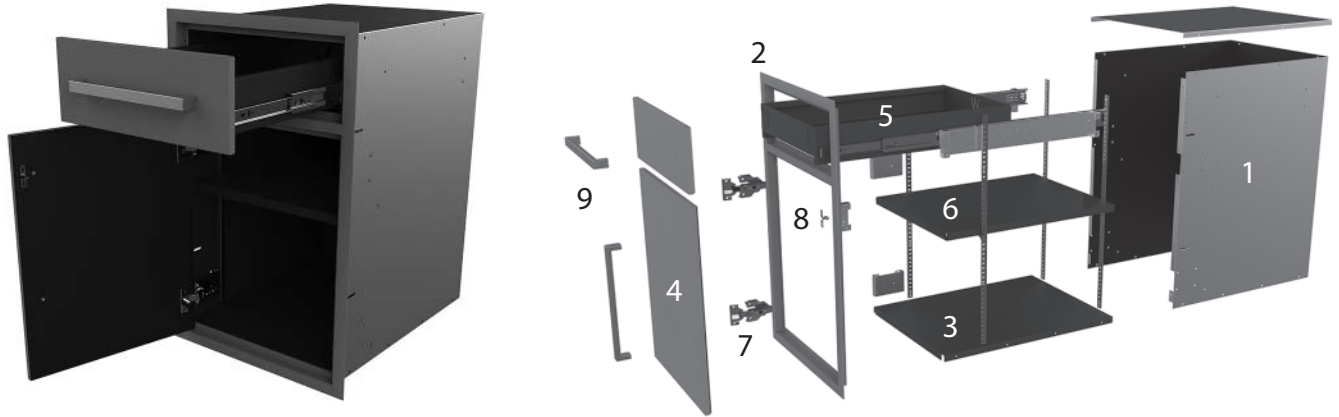

		Description
1	BOX	Seamless, one-piece side and back panel (.040 mill finish aluminum) bent for strength
2	FRAME	All aluminum, welded assembly featuring inset face frames and weather resistant powder coating
3	BOTTOM	One-piece fabricated (.060 mill finish aluminum) panel assembly
4	DOORS	Flat or Shaker door styles with matching powder coated exterior. Flat style has a painted black aluminum panel on back of the door and Shaker has a matching finish on back of door
5	DRAWERS	24" deep, aluminum, powder coat finish drawer box with 100lb full extension side mount ball bearing glides. EPDM D-seal around frame to insure a weather and pest resistant seal
6	SHELVES	Adjustable 3/4" high, full-depth shelf (.060 aluminum) with self-locking clips (60lb load rating)
7	HINGES	110 degree concealed hinge with 6 way adjustability
8	CATCH	Clip and double roller catch
9	PULLS	304 stainless steel bar pulls

Freestanding Base Cabinets

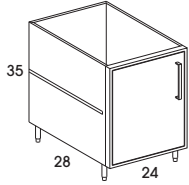
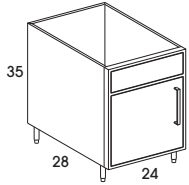
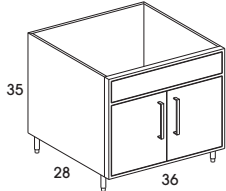
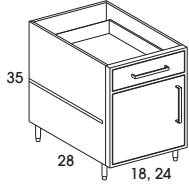
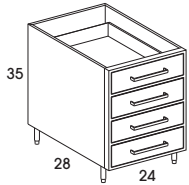
Design Tips: • Finished Back and Side Panels are not included with the cabinets and must be purchased separately; unless otherwise noted		SKU's	cubes	Flat Door Style
BASE WITH FULL HEIGHT DOOR - 35" HIGH - 28" DEEP				
	<ul style="list-style-type: none"> • One full height door (specify Left or Right hinge) • One adjustable shelf • Door handle included • Legs included • Available width: 24" 	B24FHL	14.0	1581
		B24FHR	14.0	1581
SINK BASE - 35" HIGH - 28" DEEP				
	<ul style="list-style-type: none"> • One door (specify Left or Right hinge) • One false drawer front • Door handle included • Legs included • Available width: 24" 	SB24L	14.0	1423
		SB24R	14.0	1423
	<ul style="list-style-type: none"> • Two doors • One false drawer front • Door handles included • Legs included • Available width: 36" 	SB36	21.0	1829
BASE WITH ONE DRAWER - 35" HIGH - 28" DEEP				
	<ul style="list-style-type: none"> • One door (specify Left or Right hinge) • One drawer • One adjustable shelf • Door and drawer handles included • Legs included • Available widths: 18" and 24" 	B18L	9.0	1831
		B18R	9.0	1831
		B24L	14.0	2083
		B24R	14.0	2083
FOUR DRAWER BASE - 35" HIGH - 28" DEEP				
	<ul style="list-style-type: none"> • Four drawers • Drawer fronts are 6⁹/₁₆" tall • Drawer handles included • Legs included • Available width: 24" 	DB24	14.0	3048

Freestanding Base Cabinets

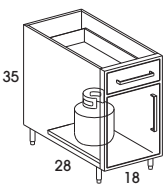
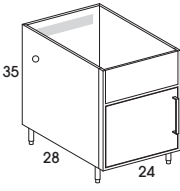
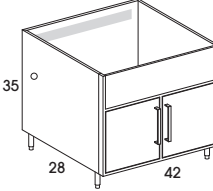
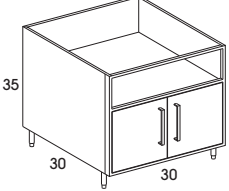
Design Tips: • Finished Back and Side Panels are not included with the cabinets and must be purchased separately; unless otherwise noted	SKU's	cubes	Flat Door Style	
PROPANE BASE - VENTILATED - 35" HIGH - 28" DEEP				
	<ul style="list-style-type: none"> • One door (Left hinge only) • One drawer • Stationary tank storage • Door and drawer handles included • Legs included • Bottom cut out to secure propane tank • Available width: 18" 	PPBV18L	11.0	1614
GAS GRILL BASE - VENTILATED - 35" HIGH - 28" DEEP				
	<ul style="list-style-type: none"> • One door (Left hinge only) • Ventilated floor and back • Front panel can be cut on site for best fit • Can be cut for an appliance up to 18" wide x 9" high (not including counter top) • Door handle included • Legs included • Available width: 24" 	GGBV24L	14.0	1411
	<ul style="list-style-type: none"> • Two doors • Ventilated floor and back • Front panel can be cut on site for best fit • Can be cut for an appliance up to 36" wide x 9" high (not including counter top) • Door handles included • Legs included • Replacement front panel available (special order) • Available width: 42" 	GGBV42	24.0	1958
CERAMIC GRILL BASE				
	<ul style="list-style-type: none"> • Two doors • Open area for control access and ventilation • Used with X-Large ceramic grills • Door handles included • Legs included • Countertop note: Cabinet depth is 30" • Available width: 30" 	GCB30	17.0	2748

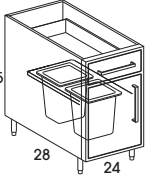
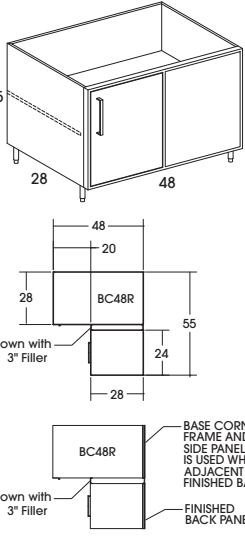
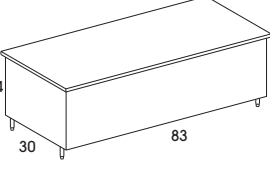

Freestanding Base Cabinets

Design Tips: • Finished Back and Side Panels are not included with the cabinets and must be purchased separately; unless otherwise noted	SKU's	cubes	Flat Door Style
BASE WASTE BIN - 35" HIGH - 28" DEEP			
 <ul style="list-style-type: none"> • One pull out door • One drawer • Two seven-gallon waste baskets included • Door and drawer handles included • Legs included • Available width: 24" 	BWB24	14.0	2546
BASE CORNER - 35" HIGH - 28" DEEP			
 <ul style="list-style-type: none"> • One full height door (specify Left or Right hinge) • One adjustable full-width shelf • Door and drawer handles included • Adjacent cabinet to attach to hinge side • Right hinge shown in illustration • Legs included • Filler panel required for door and drawer clearance when using with another base to make an L-shape • Available width: 48" • Counter top reminder: BCFFSP adds 1" to cabinet's width to align with adjacent cabinet having a back panel • BC48R shown in illustration <p>BASE CORNER FRAME AND FINISHED SIDE PANEL (BCFFSP) IS USED WHEN ADJACENT CABINET HAS A FINISHED BACK PANEL</p>	BC48L	27.0	2309
	BC48R	27.0	2309
BENCH STORAGE CABINET - 24" HIGH - 30" DEEP			
 <ul style="list-style-type: none"> • Aluminum top lid opens for storage • Lid is hinged and includes strut assist • Fits up to five standard lounge cushions inside • Legs included • Available width: 83" 	BS83	35.0	5458

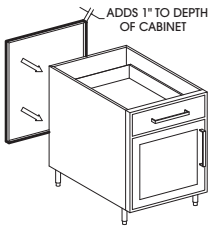
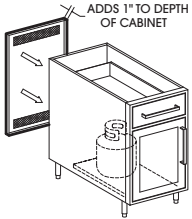
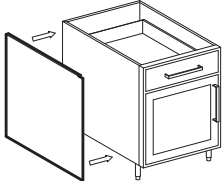
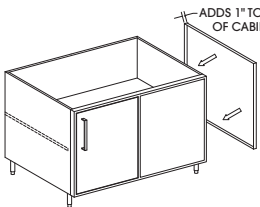
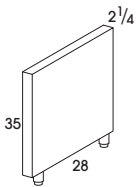
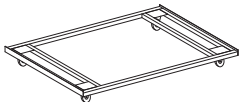
Panels / Accessories

	SKU's	cubes	Flat Door Style
FINISHED BACK PANELS			
 <ul style="list-style-type: none"> • Single color matched finished back panel • Installs onto Freestanding cabinets • Used to finish back of cabinet • Not to be used on Grill Bases <p>COUNTERTOP NOTE: Adds 1" to depth of cabinet</p>	FBP18	1.0	288
	FBP24	1.0	356
	FBP36	1.0	502
	FBP48	2.0	649
FINISHED BACK PANELS - VENTED			
 <ul style="list-style-type: none"> • Single color matched vented back panel • Installs onto Freestanding cabinets • Used to finish back of cabinet • Used on Grill Bases <p>COUNTERTOP NOTE: Adds 1" to depth of cabinet</p>	FBP18V	1.0	288
	FBP24V	1.0	356
	FBP42V	2.0	576
FINISHED SIDE PANELS			
 <ul style="list-style-type: none"> • Single color matched finished side panel • Can be used on left or right side of cabinet • Installs onto Freestanding cabinets • FSP31 used on all cabinets except GCB30 • GCB30 requires 30" deep panel FSP3130 <p>COUNTERTOP NOTE: Cabinet width does not change when side panels are applied</p>	FSP31	1.0	271
	FSP3130	1.0	288
BASE CORNER FRAME AND FINISHED SIDE PANEL			
 <ul style="list-style-type: none"> • Single color matched side panel • Used on side of Blind Corner cabinet when adjacent cabinet has finished back panel applied <p>COUNTERTOP NOTE: Adds 1" to width of cabinet</p>	BCFFSP	2.0	458
FINISHED END PANEL - 28" DEEP			
 <ul style="list-style-type: none"> • Back and ends are finished • Used to support a counter top when appliance is at the end of a cabinet run • Use multiple end panels when there are two or more appliances next to each other • Adjustable 28" to 29" deep 	FEP28	1.0	910
MOBILE BASE			
 <ul style="list-style-type: none"> • Attaches to bottom of cabinet • Black finish only • Two swivel and lock casters and two rigid casters included • 600lb load rating <p>Examples: - MB48 holds one 48" cabinet or two 24" cabinets - MB72 holds two 36" cabinets or three 24" cabinets - MB96 holds one 42", one 36", and one 18" wide cabinet</p>	MB48	4.0	581
	MB72	5.0	683
	MB96	6.0	773

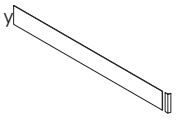
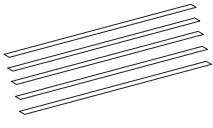
Accessories

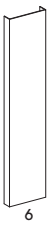
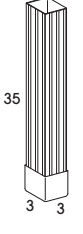
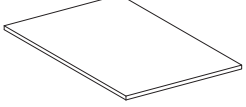
	SKU's	cubes	Price	Quantities
ADJUSTABLE TOEKICK				
 <ul style="list-style-type: none"> • Includes three clips, attaches to adjustable legs • Includes two corner pieces to be cut to desired height • Allows for 1" of floor variation • Color matched • 8 ft long, field cut to desired length 	TOEKICKKIT	0.3	526	Each
COUNTER TOP SPACER				
 <ul style="list-style-type: none"> • Used when counter top material require an even surface • 3/4" wide x 24" long • Applies to lip of cabinet top • Peel and stick application 	CTOPSPCR	0.5	68	Five
FILLER PANEL				
 <ul style="list-style-type: none"> • Used with base corner cabinets • Provides clearance when opening drawers and doors 	FP3	0.5	57	Each
 <ul style="list-style-type: none"> • Used with base corner cabinets • Provides clearance when opening drawers and doors 	FP6	0.5	74	Each
FLUTED COLUMN				
 <ul style="list-style-type: none"> • Used to support counter top overhangs • Adjustable foot at bottom • Creates unique appearances when joining cabinets together • Adds 3" to cabinet run 	COLUMNKIT	0.2	761	Each
SHELF				
 <ul style="list-style-type: none"> • Used with 24" wide cabinets • Locking shelf clips included 	SHELF2428	1.0	113	Each

Accessories

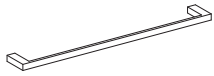
	SKU's	cubes	Price	Quantities
TOWEL BAR KIT				
 <ul style="list-style-type: none"> • Mounted on side of cabinet to hold towels and light weight items • 24" wide • Stainless Steel 	TBK	1.0	119	Each
REPLACEMENT PARTS				
Glide, Soft-Close <ul style="list-style-type: none"> • Includes hardware 	GLIDESC	1.0	68	Pair
Hinge <ul style="list-style-type: none"> • Includes hardware 	HINGE	0.1	34	Pair
Leg, Stainless Steel <ul style="list-style-type: none"> • No hardware required 	LEG	0.5	51	Each
Replacement cut-out panel for GGBV42	GGBV42COP	0.5	199	Each
TOUCH UP				
Touch up Paint – 12 oz.	TUSPRAY	0.1	52	One Spray Can
Touch up Pen	TUPEN	0.1	29	One Pen

Freestanding Base Cabinets

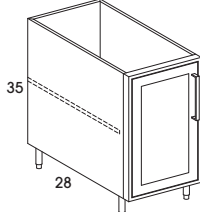
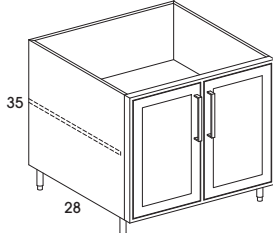
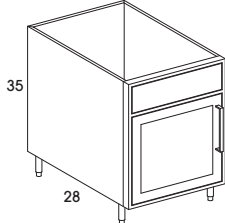
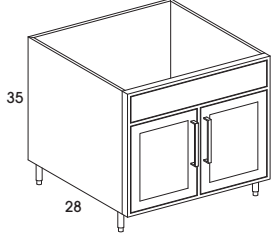
Design Tips: • Finished Back and Side Panels are not included with the cabinets and must be purchased separately; unless otherwise noted		SKU's	cubes	Flat	Shaker
BASE WITH FULL HEIGHT DOOR - 35" HIGH - 28" DEEP					
 <ul style="list-style-type: none"> • One full height door (specify Left or Right hinge) • One adjustable shelf • Door handle included • Legs included • Available widths: 12"-24" 	B12FHL	7.0	1206	1355	
	B12FHR	7.0	1206	1355	
	B15FHL	8.0	1300	1461	
	B15FHR	8.0	1300	1461	
	B18FHL	10.0	1394	1566	
	B18FHR	10.0	1394	1566	
	B21FHL	11.0	1488	1672	
	B21FHR	11.0	1488	1672	
	B24FHL	13.0	1581	1777	
	B24FHR	13.0	1581	1777	
 <ul style="list-style-type: none"> • Two full height doors • One adjustable shelf • Door handles included • Legs included • Available widths: 27"-36" 	B27FH	14.0	1821	1990	
	B30FH	15.0	1865	2095	
	B33FH	17.0	1959	2201	
	B36FH	18.0	2307	2306	
SINK BASE - 35" HIGH - 28" DEEP					
 <ul style="list-style-type: none"> • One door (specify Left or Right hinge) • One false drawer front • Door handle included • Legs included • Available widths: 18"-24" 	SB18L	1.0	1269	1426	
	SB18R	10.0	1269	1426	
	SB21R	11.0	1347	1514	
	SB21L	11.0	1347	1514	
	SB24R	14.0	1423	1601	
	SB24L	14.0	1423	1601	
 <ul style="list-style-type: none"> • Two doors • One false drawer front • Door handles included • Legs included • Available widths: 27"-48" 	SB27	14.0	1596	1793	
	SB30	15.0	1674	1881	
	SB33	17.0	1752	1968	
	SB36	21.0	1829	2056	
	SB39	22.0	1908	2144	
	SB42	24.0	1986	2232	
	SB45	25.0	2064	2319	
	SB48	26.0	2142	2407	

Freestanding Base Cabinets

Design Tips:

- Finished Back and Side Panels are not included with the cabinets and must be purchased separately; unless otherwise noted

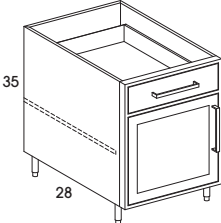
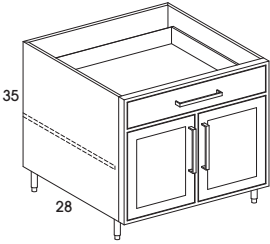
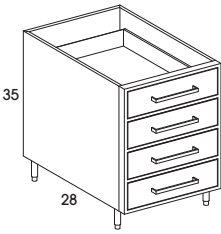
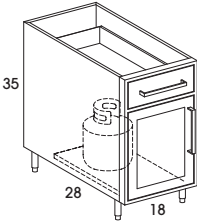
	SKU's	cubes	Flat	Shaker
BASE WITH ONE DRAWER – 35" HIGH – 28" DEEP				
 <ul style="list-style-type: none"> One door (specify Left or Right hinge) One drawer One adjustable shelf Door and drawer handles included Legs included Available widths: 15"-24" 	B15L	8.0	1704	1915
	B15R	8.0	1704	1915
	B18L	9.0	1831	2057
	B18R	9.0	1831	2057
	B21L	11.0	1957	2199
	B21R	11.0	1957	2199
	B24L	14.0	2083	2341
	B24R	14.0	2083	2341
 <ul style="list-style-type: none"> Two doors One drawer One adjustable shelf Door handles included Legs included Available widths: 27"-36" 	B27	14.0	2308	2593
	B30	15.0	2434	2735
	B33	17.0	2561	2877
	B36	21.0	2687	3019
FOUR DRAWER BASE – 35" HIGH – 28" DEEP				
 <ul style="list-style-type: none"> Four drawers Drawer fronts are 6 9/16" tall Drawer handles included Legs included Available widths: 15"-36" 	DB15	8.0	2484	2484
	DB18	9.0	2673	2673
	DB21	11.0	2861	2861
	DB24	14.0	3048	3048
	DB27	14.0	3239	3239
	DB30	15.0	3427	3427
	DB33	17.0	3616	3616
	DB36	18.0	3804	3804
PROPANE BASE – VENTILATED – 35" HIGH – 28" DEEP				
 <ul style="list-style-type: none"> One door (specify Left or Right hinge) One drawer Stationary tank storage Door and drawer handles included Legs included Bottom cut out to secure propane tank Available width: 18" 	PPBV18L	11.0	1614	1818
	PPBV18R	11.0	1614	1818

Freestanding Base Cabinets

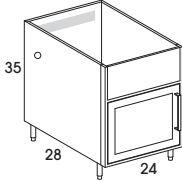
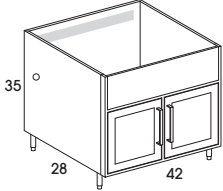
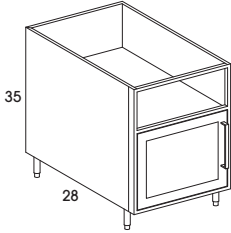
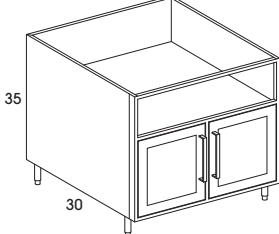
Design Tips: • Finished Back and Side Panels are not included with the cabinets and must be purchased separately; unless otherwise noted		SKU's	cubes	Flat	Shaker
GAS GRILL BASE - VENTILATED - 35" HIGH - 28" DEEP					
 <ul style="list-style-type: none"> • One door (specify Left or Right hinge) • Ventilated floor and back • Front panel can be cut on site for best fit • Can be cut for an appliance • Cut-out height = 9" (not including counter top) • Cut-out width = cabinet width minus 6" • Door handle included • Legs included • Available widths: 18"-24" 	GGBV18L	9.0	1261	1416	
	GGBV18R	9.0	1261	1416	
	GGBV21L	11.0	1336	1502	
	GGBV21R	11.0	1336	1502	
	GGBV24L	14.0	1411	1587	
	GGBV24R	14.0	1411	1587	
	GAS GRILL BASE - VENTILATED - 35" HIGH - 28" DEEP				
 <ul style="list-style-type: none"> • Two doors • Ventilated floor and back • Front panel can be cut on site for best fit • Can be cut for an appliance up to • Cut-out height = 9" (not including counter top) • Cut-out width = cabinet width minus 6" • Door handles included • Legs included • Replacement front panel available (special order) • Available widths: 27"-48" 	GGBV27	14.0	1580	1776	
	GGBV30	15.0	1656	1861	
	GGBV33	17.0	1732	1946	
	GGBV36	18.0	1808	2032	
	GGBV39	22.0	1884	2117	
	GGBV42	24.0	1958	2202	
	GGBV45	25.0	2036	2288	
	GGBV48	26.0	2112	2373	
CERAMIC GRILL BASE					
 <ul style="list-style-type: none"> • One Door (specify Left or Right hinge) • Open area for control access and ventilation • Used with Large ceramic grills • Door handle included • Legs included • Countertop note: Cabinet depth is 28" • Available width: 24" 	GCB24L	14.0	2491	2799	
	GCB24R	14.0	2491	2799	
 <ul style="list-style-type: none"> • Two doors • Open area for control access and ventilation • Used with X-large ceramic grills • Door handles included • Legs included • Countertop note: Cabinet depth is 30" • Available width: 30" 	GCB30	15.0	2748	3088	

Freestanding Base Cabinets

Design Tips:

- Finished Back and Side Panels are not included with the cabinets and must be purchased separately; unless otherwise noted

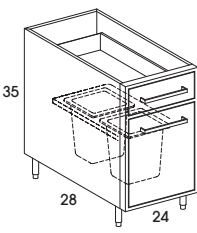
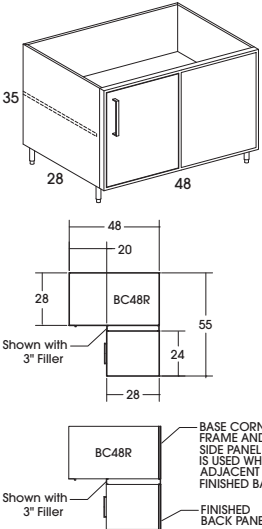
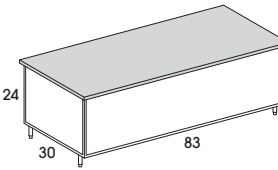
	SKU's	cubes	Flat	Shaker
BASE WASTE BIN – 35" HIGH – 28" DEEP				
 <ul style="list-style-type: none"> One pull out door One drawer Two seven-gallon waste baskets included Door and drawer handles included Legs included Available width: 24" 	BWB24	14.0	2546	2861
BASE CORNER – 35" HIGH – 28" DEEP				
 <ul style="list-style-type: none"> One full height door (specify Left or Right hinge) One adjustable full-width shelf Door and drawer handles included Adjacent cabinet to attach to hinge side Right hinge shown in illustration Legs included Filler panel required for door and drawer clearance when using with another base to make an L-shape Available width: 48" Counter top reminder: BCFSP adds 1" to cabinet's width to align with adjacent cabinet having a back panel BC48R shown in illustration <p>BC48R</p> <p>BASE CORNER FRAME AND FINISHED SIDE PANEL (BCFFSP) IS USED WHEN ADJACENT CABINET HAS A FINISHED BACK PANEL</p> <p>FINISHED BACK PANEL</p>	BC48L	27.0	2309	2595
	BC48R	27.0	2309	2595
BENCH STORAGE CABINET – 24" HIGH – 30" DEEP				
 <ul style="list-style-type: none"> Aluminum top lid opens for storage Lid is hinged and includes strut assist Fits up to five standard lounge cushions inside Legs included Available width: 83" 	BS83	35.0	5458	5458

Wall Cabinets

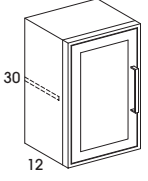
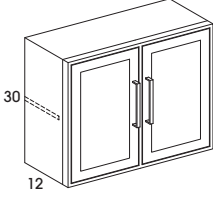
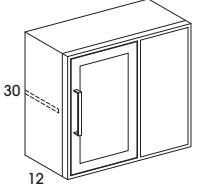
Design Tips: • Wall cabinets come with finished sides, tops, and bottoms		SKU's	cubes	Flat	Shaker
WALL CABINET - SINGLE DOOR					
 <ul style="list-style-type: none"> • One door (specify Left or Right hinge) • One adjustable shelf • Door handle included • Sides, tops, and bottoms are finished • Available widths: 12"-24" 	W1230L	3.0	1212	1418	
	W1230R	3.0	1212	1418	
	W1530L	4.0	1351	1564	
	W1530R	4.0	1351	1564	
	W1830L	5.0	1489	1709	
	W1830R	5.0	1489	1709	
	W2130L	5.0	1628	1854	
	W2130R	5.0	1628	1854	
	W2430L	6.0	1766	2076	
	W2430R	6.0	1766	2076	
WALL CABINET - DOUBLE DOOR					
 <ul style="list-style-type: none"> • Two doors • One adjustable shelf • Door handle included • Sides, tops, and bottoms are finished • Available widths: 27"-36" 	W2730	7.0	1978	2222	
	W3030	8.0	2116	2367	
	W3330	9.0	2255	2454	
	W3630	10.0	2393	2513	
WALL CORNER					
 <ul style="list-style-type: none"> • One door (specify Left or Right hinge) • One adjustable shelf • Door handle included • Sides, tops, and bottoms are finished • WC36R shown in illustration • Available width: 36" 	WC3630L	10.0	2337	2294	
	WC3630R	10.0	2337	2294	

Tall Cabinets

Design Tips:

- Tall cabinets come with finished sides

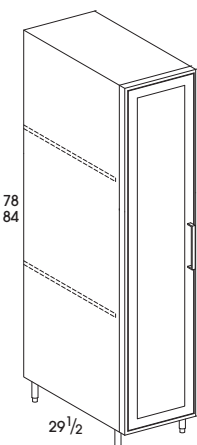
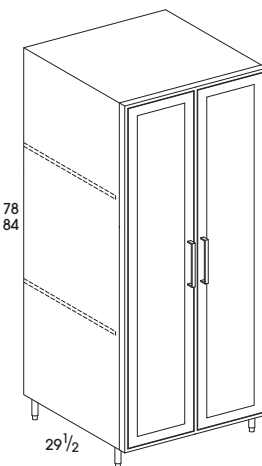
		SKU's	cubes	Flat	Shaker
TALL — SINGLE DOOR					
 <p>78 84</p> <p>29 1/2</p>	<ul style="list-style-type: none"> • One door (specify Left or Right hinge) • Two adjustable shelves included • Door handle included • Available heights: 78" and 84" • Must be secured to wall or adjacent cabinets • Sides, tops and bottoms are finished • Available depth: 29 1/2" • Available width: 24" 	U247828L	33.0	3308	3474
		U247828R	33.0	3308	3474
		U248428L	33.0	3495	3670
		U248428R	33.0	3495	3670
TALL — DOUBLE DOOR					
 <p>78 84</p> <p>29 1/2</p>	<ul style="list-style-type: none"> • Two doors • Two adjustable shelves included • Door handle included • Available height: 78" and 84" • Must be secured to wall or adjacent cabinets • Sides, tops and bottoms are finished • Available depth: 29 1/2" • Available width: 36" 	U367828	47.0	4320	4536
		U368428	51.0	4561	4789

Hardscape Inserts

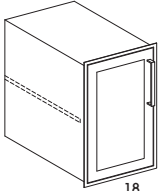
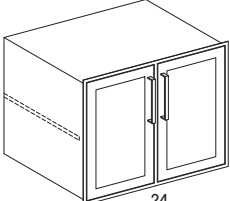
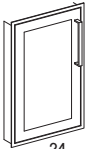
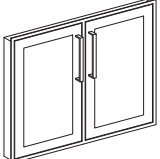
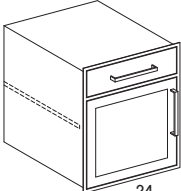
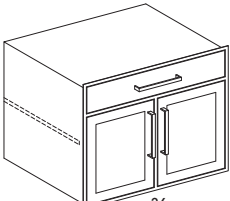
Design Tips: • Cabinets do not require finished side or back panels		SKU's	cubes	Flat	Shaker
FULL HEIGHT DOOR INSERT					
	<ul style="list-style-type: none"> • One full height door (specify Left or Right hinge) • Full enclosure • One adjustable full depth shelf • Cut-out Dimension: 16 1/2"W x 27 1/2"H • Door handle included • Available width: 18" 	B18FHLHI	11.0	1170	1228
		B18FHRHI	11.0	1170	1228
	<ul style="list-style-type: none"> • Two full height doors • Full enclosure • One adjustable full depth shelf • Cut-out Dimension (36"): 34 1/2"W x 27 1/2"H • Door handles included • Available width: 24" 	B36FHHI	14.0	1979	2078
		B40FHHI	15.0	2125	2231
DOOR AND FRAME					
	<ul style="list-style-type: none"> • One full height door (specify Left or Right hinge) • Door and frame assembly only • Cut-out Dimension: 22 1/2"W x 27 1/2"H • Door handle included • Available width: 24" 	B24FHLFFHI	1.0	718	754
		B24FHRFFHI	1.0	718	754
UNDER GRILL DOOR AND FRAME					
	<ul style="list-style-type: none"> • Two full height doors • Door and frame assembly only • Cut-out Dimension (36"): 34 1/2"W x 27 1/2"H • Cut-out Dimension (40"): 38 1/2"W x 27 1/2"H • Door handles included • Available widths: 36" and 40" 	B36FHFFHI	1.0	758	796
		B40FHFFHI	1.0	804	844
DOOR AND DRAWER INSERT					
	<ul style="list-style-type: none"> • One door (specify Left or Right hinge) • One drawer - drawer front is flat • Full enclosure • One adjustable full depth shelf • Cut-out Dimension: 22 1/2"W x 27 1/2"H • Door handle included • Available width: 24" 	B24LHI	14.0	3051	3204
		B24RHI	14.0	3051	3204
	<ul style="list-style-type: none"> • Two doors • One drawer - drawer front is flat • Full enclosure • One adjustable full depth shelf • Cut-out Dimension: 34 1/2"W x 27 1/2"H • Door handles included • Available width: 36" 	B36HI	14.0	2571	2700

Hardscape Inserts

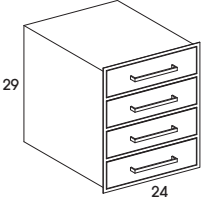
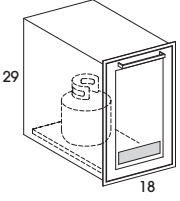
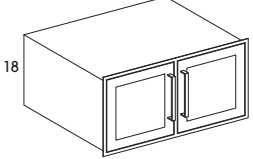
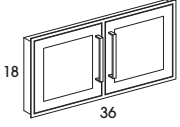
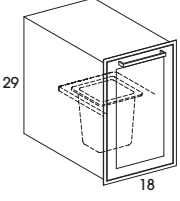
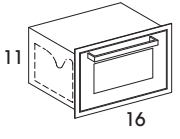
Design Tips: • Finished Back and Side Panels are not included with the cabinets and must be purchased separately; unless otherwise noted		SKU's	cubes	Flat	Shaker
DRAWER INSERT					
	<ul style="list-style-type: none"> • Four drawers • All drawer fronts are flat • Full enclosure • Cut-out Dimension: 22 1/2"W x 27 1/2"H • Door handle included • Available width: 24" 	DB24HI	14.0	2726	2726
PROPANE PULL-OUT INSERT - VENTED					
	<ul style="list-style-type: none"> • One full height door • Full enclosure • No shelf • Pull-out hold standard LP tanks • Vented through door • Cut-out Dimension: 16 1/2"W x 27 1/2"H • Door handle included • Available width: 18" 	PPBV18HI	11.0	1704	1789
UNDER GRILL INSERT					
	<ul style="list-style-type: none"> • Two full height doors • Full enclosure • No shelf • Cut-out Dimension (36"): 34 1/2"W x 16 1/2"H • Cut-out Dimension (40"): 38 1/2"W x 16 1/2"H • Door handles included • Available widths: 36" and 40" 	GU36HI	14.0	1502	1577
		GU40HI	15.0	1527	1604
UNDER GRILL DOOR AND FRAME					
	<ul style="list-style-type: none"> • Two full height doors • Door and frame assembly only • Cut-out Dimension: 34 1/2"W x 16 1/2"H • Door handles included • Available width: 36" 	GU36FFHI	1.0	641	673
WASTE BIN PULL-OUT INSERT					
	<ul style="list-style-type: none"> • One full height door • Full enclosure • No shelf • Pull-out includes waste bin • Cut-out Dimension: 16 1/2"W x 27 1/2"H • Door handles included • Available width: 18" 	BWB18HI	11.0	1513	1588
PAPER TOWEL HOLDER					
	<ul style="list-style-type: none"> • One door, bottom hinge • Full enclosure • Includes paper towel holder • Cut-out Dimension: 14 1/2"W x 9 1/2"H • Door handles included • Available width: 16" 	BPT16HI	1.0	524	551



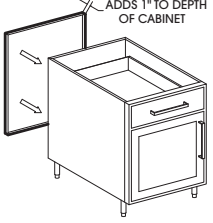
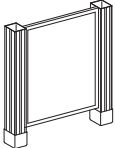
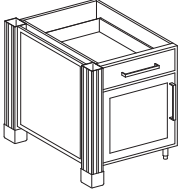
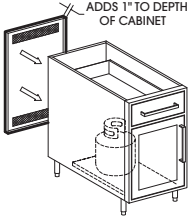

Panels

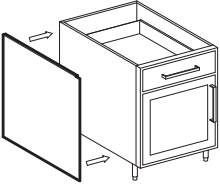
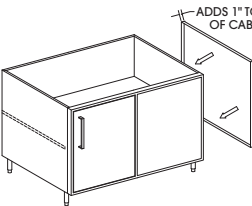
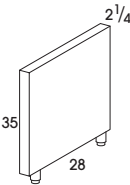
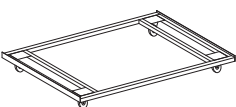
	SKU's	cubes	Flat Door Style
FINISHED BACK PANELS			
 <p>ADDS 1" TO DEPTH OF CABINET</p> <ul style="list-style-type: none"> • Single color matched finished back panel • Installs onto Freestanding cabinets • Used to finish back of cabinet • FBP's can be used with column kits to create decorative supports • FBP23 used with column kits to create decorative sides • FBP2474, FBP2480, FBP3674 and FBP3680 are used on Tall cabinets <p>COUNTERTOP NOTE: Adds 1" to depth of cabinet</p>  <p>Finished back panels and column kits used to create decorative supports</p>  <p>FBP23 shown with column kits attached to side of freestanding cabinet</p>	FBP12	1.0	218
	FBP15	1.0	253
	FBP18	1.0	288
	FBP21	1.0	323
	FBP23	1.0	343
	FBP24	1.0	356
	FBP27	1.0	410
	FBP30	1.0	445
	FBP33	1.0	480
	FBP36	1.0	502
	FBP39	2.0	551
	FBP42	2.0	586
	FBP45	2.0	621
	FBP48	2.0	649
	FBP2474	2.0	765
	FBP2480	2.0	828
	FBP3674	3.0	1062
FBP3680	3.0	1142	
FINISHED BACK PANELS - VENTED			
 <p>ADDS 1" TO DEPTH OF CABINET</p> <ul style="list-style-type: none"> • Single color matched vented back panel • Installs onto Freestanding cabinets • Used to finish back of cabinet • Used on Grill Bases <p>COUNTERTOP NOTE: Adds 1" to depth of cabinet</p>	FBP18V	1.0	288
	FBP21V	1.0	323
	FBP24V	1.0	356
	FBP27V	1.0	410
	FBP30V	1.0	445
	FBP33V	1.0	480
	FBP36V	1.0	515
	FBP39V	2.0	551
	FBP42V	2.0	576
	FBP45V	2.0	621
	FBP48V	2.0	656

Panels / Accessories

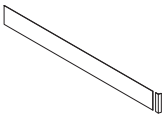
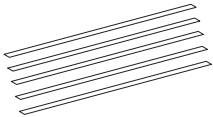
	SKU's	cubes	Flat Door Style
FINISHED SIDE PANELS			
 <ul style="list-style-type: none"> • Single color matched finished side panel • Can be used on left or right side of cabinet • Installs onto Freestanding cabinets • FSP31 used on all cabinets except GCB30 • GCB30 requires 30" deep panel FSP3130 <p>COUNTERTOP NOTE: Cabinet width does not change when side panels are applied</p>	FSP31	1.0	271
	FSP3130	1.0	288
BASE CORNER FRAME AND FINISHED SIDE PANEL			
 <p>ADDS 1" TO DEPTH OF CABINET</p> <ul style="list-style-type: none"> • Single color matched back panel • Installs onto Freestanding cabinets • Used on side of Blind Corner Base cabinet when adjacent cabinet has finished back panel applied <p>COUNTERTOP NOTE: Adds 1" to width of cabinet</p>	BCFFSP	3.0	458
FINISHED END PANEL - 28" DEEP			
 <ul style="list-style-type: none"> • Back and ends are finished • Used to support a counter top when appliance is at the end of a cabinet run • Use multiple end panels when there are two or more appliances next to each other • Adjustable 28" to 29" deep 	FEP28	1.0	910
MOBILE BASE			
 <ul style="list-style-type: none"> • Attaches to bottom of cabinet • Black finish only • Two swivel and lock casters and two rigid casters included • 600lb load rating <p>Examples: - MB48 holds one 48" cabinet or two 24" cabinets - MB72 holds two 36" cabinets or three 24" cabinets - MB96 holds one 42", one 36", and one 18" wide cabinet</p>	MB48	4.0	581
	MB72	5.0	683
	MB96	6.0	773

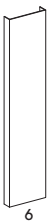
Accessories

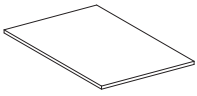
	SKU's	cubes	Price	Quantities
ADJUSTABLE TOEKICK				
 <ul style="list-style-type: none"> • Includes three clips, attaches to adjustable legs • Includes two corner pieces to be cut to desired height • Allows for 1" of floor variation • Color matched • 8 ft long, field cut to desired length 	TOEKICKKIT	0.3	526	Each
COUNTER TOP SPACER				
 <ul style="list-style-type: none"> • Used when counter top material require an even surface • 3/4" wide x 24" long • Applies to lip of cabinet top • Peel and stick application 	CTOPSPCR	0.5	68	Five
FILLER PANEL				
 <ul style="list-style-type: none"> • Used with base corner cabinets • Provides clearance when opening drawers and doors 	FP3	0.5	57	Each
 <ul style="list-style-type: none"> • Used with base corner cabinets • Provides clearance when opening drawers and doors 	FP6	0.5	74	Each
FLUTED COLUMN				
 <ul style="list-style-type: none"> • Used to support counter top overhangs • Adjustable foot at bottom • Creates unique appearances when joining cabinets together • Adds 3" to cabinet run 	COLUMNKIT	0.2	761	Each
SHELF				
 <ul style="list-style-type: none"> • Used with 24" wide cabinets • Locking shelf clips included 	SHELF2428	1.0	113	Each

Accessories

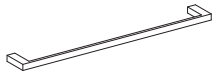
	SKU's	cubes	Price	Quantities
TOWEL BAR KIT				
 <ul style="list-style-type: none"> • Mounted on side of cabinet to hold towels and light weight items • 24" wide • Stainless Steel 	TBK	1.0	119	Each
REPLACEMENT PARTS				
Glide, Soft-Close <ul style="list-style-type: none"> • Includes hardware 	GLIDESC	1.0	68	Pair
Hinge <ul style="list-style-type: none"> • Includes hardware 	HINGE	0.1	34	Pair
Leg, Stainless Steel <ul style="list-style-type: none"> • No hardware required 	LEG	0.5	51	Each
Replacement cut-out panel for Gas Grill Bases (GGB)	GGBV18COP	0.5	79	Each
	GGBV21COP	0.5	94	Each
	GGBV24COP	0.5	119	Each
	GGBV27COP	0.5	124	Each
	GGBV30COP	0.5	139	Each
	GGBV33COP	0.5	154	Each
	GGBV36COP	0.5	169	Each
	GGBV39COP	0.5	184	Each
	GGBV42COP	0.5	199	Each
	GGBV45COP	0.5	214	Each
GGBV48COP	0.5	229	Each	
TOUCH UP				
Touch up Paint - 12 oz.	TUSPRAY	0.1	52	One Spray Can
Touch up Pen	TUPEN	0.1	29	One Pen

ALUMINUM COUNTERTOPS



- Aluminum countertop is 1 1/4" thick
- Constructed of .090 gauge material
- Fabricated to your specific Endurance cabinet and appliance layout
- Powder coated finish
- Four depth choices
- Four color choices
- Can be used in outdoor environments, including salt air and water
- Does not rust, corrode, swell or warp



Textured Black



Walnut



Silver



Copper

ALUMINUM COUNTERTOP SPECIFICATIONS

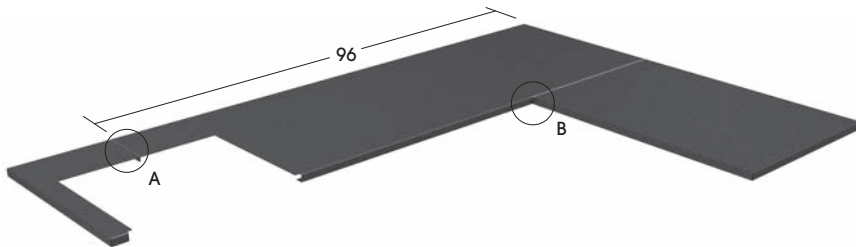

- Countertop sections can run up to 96" long without a seam
- (A) Seams can be hidden behind appliances
- Seams can not be hidden behind sink openings
- (B) Directional changes (L-shape or U-shape) require seaming multiple tops
- (C) Sections are joined using bolts through pre-located holes
- (D) Tops are secured to top edge of cabinets using sheet metal screws through underside of top
- Seams and joint between top of cabinet to be sealed with silicon or gasket material

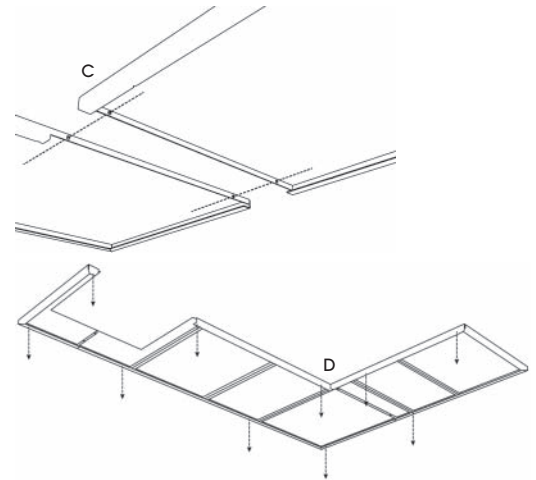

ALUMINUM COUNTERTOP DEPTH

- Aluminum countertops are available in four depths: 29", 31", 33" and 42"
- X-Large ceramic grills may require a 30" deep cabinet
- Countertop overhang for seating should be structurally supported

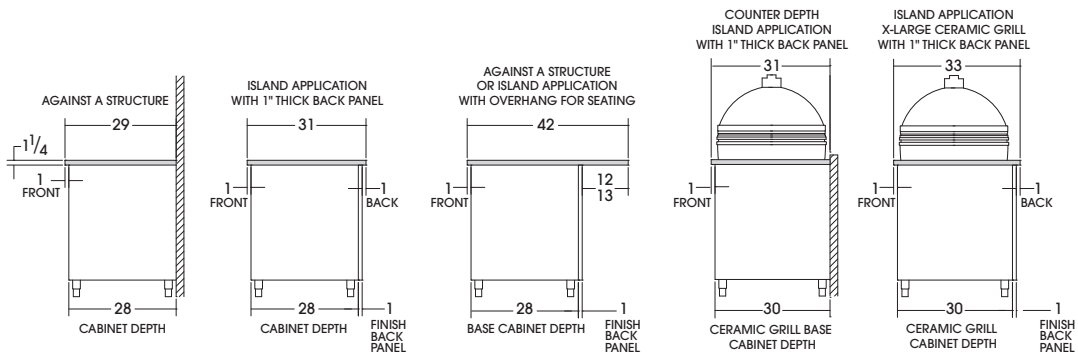

ALUMINUM COUNTERTOPS

- Countertop widths can run up to 96" long without requiring a seam
 - Widths come in 1" increments
 - When planning for a seam, two sections of countertop should connect between two cabinets for structural integrity and fastening (Countertop A)
 - Countertops less than 96" long having an appliance cut out are one piece (Countertop B)
 - Countertops greater than 96" long with an appliance can have a seam at the appliance (Countertop C)
- Note:** Seams may not be positioned at a sink
- Multi-directional Countertops require a seam at a 90-degree turn (Countertop D)
 - When Overhang for seating should be structurally supported (Countertop D)
 - X-LARGE Ceramic Grill Bases are 30" deep. Seam to always fall where the cabinets transition from 30" to 29" deep (Countertop E) Layouts B, C, and D are Endurance combination cabinet layouts

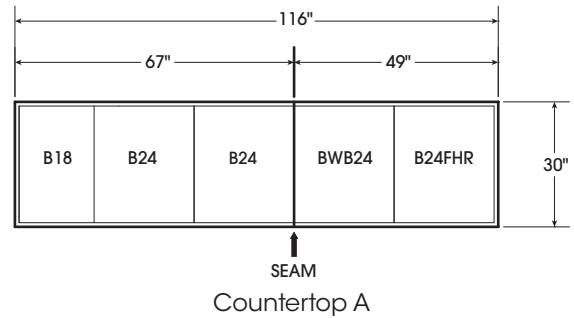

STAYCATION – Cabinet layout shown against wall

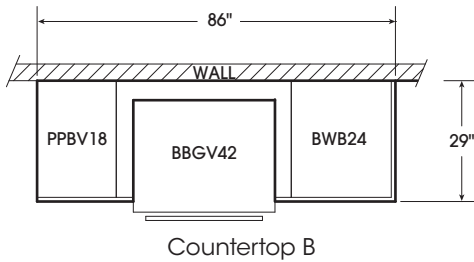

OASIS – Island layout with Finished Back Panels applied

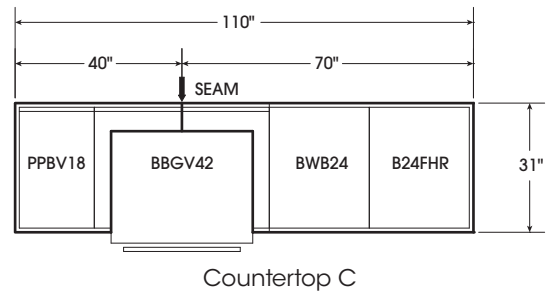

REGAL – Cabinet layout shown against one wall and seating overhand

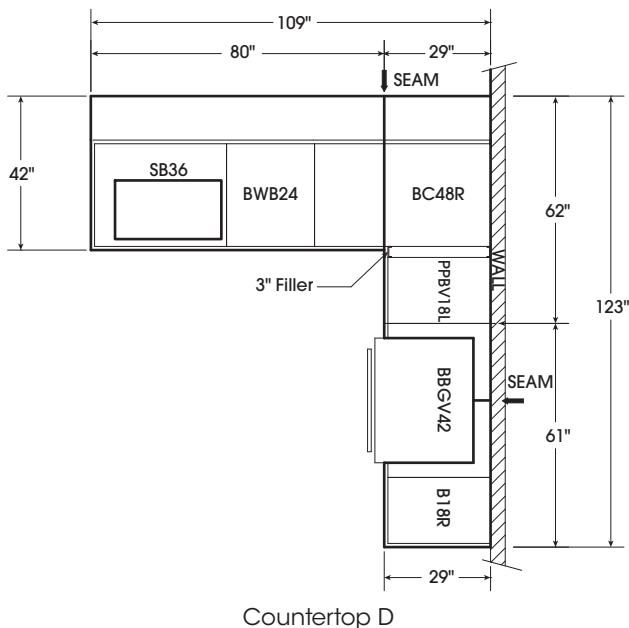

X-LARGE CERAMIC GRILL – Cabinet layout shown against a wall

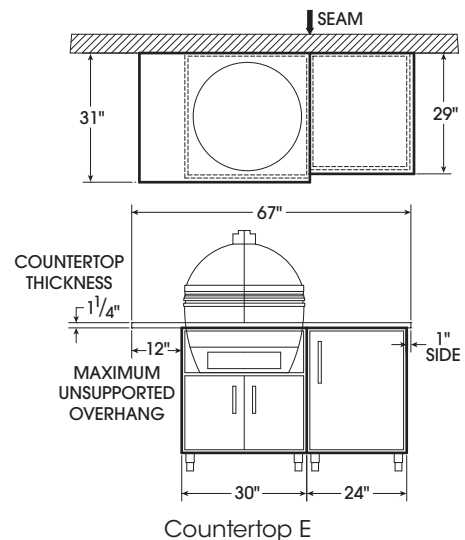

Aluminum Countertops

	Countertop Depth	Lineal/Inch
ALUMINUM COUNTERTOPS		
	29"	36
	31"	38
	33"	41
	42"	52

	Backsplash Height	Lineal/Inch
BACKSPLASH		
	4"	5

SINK, FAUCET AND STRAINER - STANDARD		
 	<ul style="list-style-type: none"> • Top mounted sink • 18 gauge, 201 series stainless steel • Brushed satin finish • One piece construction • Offset drain • Faucet - PVD Brushed-nickel finish • 360-degree spout • Faucet mounted on sink • Faucet ships uninstalled 	<p>Sink Faucet Strainer</p> <p>621</p>

SINK, FAUCET AND STRAINER - PREMIUM		
 	<ul style="list-style-type: none"> • Undermounted sink • 18 gauge, 201 series stainless steel • Brushed satin finish • One piece construction • Offset drain • Faucet - PVD Brushed-nickel finish • 360-degree spout • Faucet mounted on sink • Sink comes installed under countertop • Faucet ships uninstalled 	<p>Sink Faucet Strainer</p> <p>1842</p>



Wolf Home Products® is an innovator in the building products industry. We've cultivated more than 175 years of business experience into a total satisfaction guarantee. With our vast inventory of kitchen and bath, outdoor living and building products, we deliver your orders in a fraction of the time and ensure you get unparalleled value — when and where you need it. Wolf stands behind our service because, above all, Wolf stands behind you.



Kitchen & Bath



Outdoor Living



Building Products

wolfhomeproducts.com | © 2019 Wolf Home Products. All Rights Reserved.

All photos and colors are representative of product. Please review an actual product sample with your dealer before making your final selection.

